

## CW SERIES | 240 VAC

### PANEL MOUNT SOLID STATE RELAYS

The Sensata | Crydom CW Series Panel Mount AC output Solid State Relays offer a back-to-back SCR output for reliable switching of commercial and heavy industrial loads. This type of high performing SSR is available with output ratings from 10 Amps up to 125 Amps at 24 to 280 VAC. The CW Series panel mount solid state relay includes a removable IP20 “touch-safe” cover for added safety and is also available with zero voltage turn-on (for resistive loads) or instantaneous turn-on (for inductive loads) outputs.



### Features

- Ratings from 10 A to 125 A @ 24-280 VAC
- SCR Output for heavy industrial loads
- LED Status Indicator
- UL/CSA/TUV Approved, CE Compliant to EN60950-1
- Improved SEMS screw and washer
- Redesigned housing with anti-rotation barriers
- AC or DC control and Universal AC/DC control
- EMC Compliant to Level 3
- Epoxy Free Design
- Removable IP20 touch-safe cover
- DBC substrate for superior thermal performance

### PRODUCT SELECTION

Control Voltage	10 A	25 A	50 A	90 A	125 A
3-32 VDC	CWD2410	CWD2425	CWD2450	CWD2490	CWD24125
90-280 VAC	CWA2410	CWA2425	CWA2450	CWA2490	CWA24125
18-36 VAC	CWA2410E	CWA2425E	CWA2450E	CWA2490E	CWA24125E
20-48 VDC/20-280 VAC	CWU2410	CWU2425	CWU2450	CWU2490	CWU24125

### SPECIFICATIONS

Output <sup>(1)</sup>

Description	10 A	25 A	50 A	90 A	125 A
Operating Voltage (47-440Hz) [Vrms]	24-280	24-280	24-280	24-280	24-280
Transient Overvoltage [Vpk] <sup>(2)</sup>	600	600	600	600	600
Maximum Off-State Leakage Current @ Rated Voltage [mA <sub>rms</sub> ]	1	1	1	1	1
Minimum Off-State dv/dt @ Maximum Rated Voltage [V/μsec]	500	500	500	500	500
Maximum Load Current [Arms] <sup>(3)</sup>	10	25	50	90	125
Minimum Load Current [Arms]	150	150	150	250	250
Maximum 1 Cycle Surge Current (50/60Hz) [A <sub>pk</sub> ]	380/400	570/600	810/850	1290/1350	1900/2000
Maximum On-State Voltage Drop @ Rated Current [V <sub>pk</sub> ]	1.3	1.3	1.3	1.3	1.25
Thermal Resistance Junction to Case (R <sub>jc</sub> ) [°C/W]	0.35	0.3	0.2	0.16	0.11
Maximum 1/2 Cycle I <sup>2</sup> t for Fusing (50/60Hz, 1/2 cycle) [A <sup>2</sup> sec]	720/660	1620/1500	3280/3000	8320/7560	18000/16600

<b>Minimum Power Factor (with Maximum Load) <sup>(2)</sup></b>	0.5	0.5	0.5	0.5	0.5
<b>HP Rating UL 508/IEC60947 [-10 Option][HP (KW)]: 120 VAC</b>	0.5 (0.37)	1 (0.74)	2 (1.5)	3 (2.24)	5 (3.37)
<b>HP Rating UL 508/IEC60947 [-10 Option][HP (KW)]: 240 VAC</b>	1.5 (1.1)	3 (2.2)	5 (3.73)	7.5 (5.6)	10 (7.5)
<b>HP Rating UL 508/IEC60947 [HP (KW)]: 120 VAC</b>	0.5 (0.37)	0.75 (0.56)	1 (0.74)	2 (1.5)	3 (2.24)
<b>HP Rating UL 508/IEC60947 [HP (KW)]: 240 VAC</b>	1.5 (1.1)	2 (1.5)	3 (2.2)	5 (3.73)	7.5 (5.6)

Input <sup>(1)</sup>

Description	CWD	CWA	CWAxxxxE	CWU
<b>Control Voltage Range</b>	3-32 VDC	90-280 VAC <sup>(4)</sup>	18-36 VAC	20-48 VDC/ 20-280 VAC
<b>Maximum Reverse Voltage</b>	-32 VDC	-	-	-
<b>Minimum Turn-On Voltage</b>	3 VDC <sup>(5)</sup>	90 VAC	18 VAC	19 VDC/VAC
<b>Must Turn-Off Voltage</b>	1 VDC	10 VAC	4 VAC	5 VDC/VAC
<b>Minimum Input Current (for on-state)</b>	10 mA	6 mA	13 mA	7/13 mA
<b>Maximum Input Current</b>	15 mA	10 mA	15 mA	11/9 mA
<b>Nominal Input Impedance</b>	Current Regulated	Current Regulated	Current Regulated	Current Regulated
<b>Maximum Turn-On Time [msec]</b>	1/2 Cycle <sup>(6)</sup>	20	20	20
<b>Maximum Turn-Off Time [msec]</b>	1/2 Cycle	30	30	30

General <sup>(1)</sup>

Description	Parameters
<b>Dielectric Strength, Input/Output/Base (50/60Hz)</b>	4000 Vrms
<b>Minimum Insulation Resistance (@ 500 VDC)</b>	10 <sup>9</sup> Ohms
<b>Maximum Capacitance, Input/Output</b>	8 pF
<b>Ambient Operating Temperature Range <sup>(7)</sup></b>	-40 to 80 °C
<b>Ambient Storage Temperature Range</b>	-40 to 125 °C
<b>Weight (typical)</b>	2.88 oz (81.53 g)
<b>Housing Material</b>	UL94 V-0
<b>Baseplate Material</b>	Aluminum
<b>Input Terminal Screw Torque Range (lb-in/Nm)</b>	13-15 / 1.5-1.7
<b>Load Terminal Screw Torque Range (lb-in/Nm)</b>	18-20 / 2-2.2
<b>SSR Mounting Screw Torque Range (lb-in/Nm)</b>	18-20 / 2-2.2
<b>Input/Output Terminal Screw Thread Size</b>	#6-32 UNC / #8-32 UNC
<b>Humidity per IEC60068-2-78</b>	93% non-condensing
<b>LED Input Status Indicator</b>	Green
<b>MTBF (Mean Time Between Failures) at 40°C ambient temperature <sup>(8)</sup></b>	11,641,553 hours (1,328 years)
<b>MTBF (Mean Time Between Failures) at 60°C ambient temperature <sup>(8)</sup></b>	7,210,376 hours (823 years)

# WIRING DIAGRAM

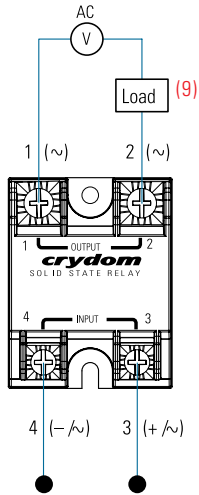

Recommended Wire Sizes		
Terminals	Wire Size (Solid / Stranded)	Wire Pull-Out Strength (lb)[N]
Input	24 AWG (0.2 mm <sup>2</sup> ) / 0.2 [minimum]	10 [44.5]
	2 x 12 AWG (3.3 mm <sup>2</sup> ) / 3.3 [maximum]	90 [400]
Output	20 AWG (0.5 mm <sup>2</sup> ) / 0.518 [minimum]	30 [133]
	2 x 10 AWG (5.3 mm <sup>2</sup> ) / 5.3 [maximum]	110 [490]
	2 x 8 AWG (8.4 mm <sup>2</sup> ) / 8.4 [maximum]	90 [400]

# EQUIVALENT CIRCUIT BLOCK DIAGRAMS

CWD Series DC Control

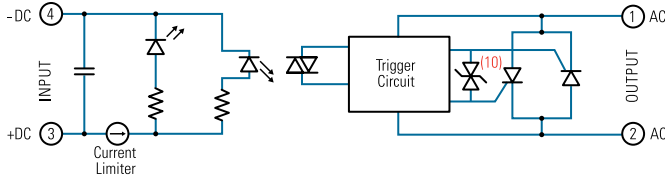

CWA/CWU Series AC Control

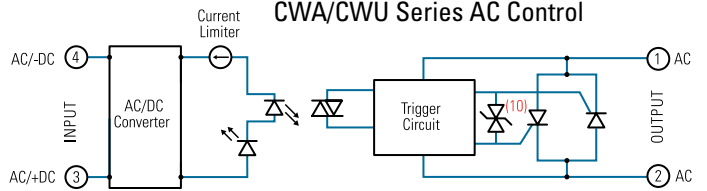

Input Current vs Input Voltage  
Standard Regulated DC Input

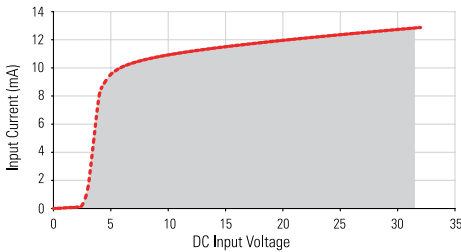

Input Current vs Input Voltage  
Standard Regulated AC Input

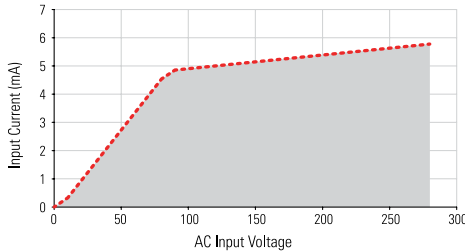

Input Current vs Input Voltage  
Regulated AC Input Option "E"

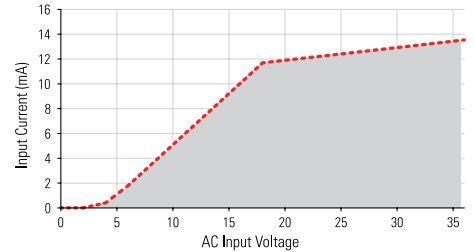

# MECHANICAL SPECIFICATIONS (1)

\*Tolerances: ±0.02 in / 0.5 mm All dimensions are in: inches [millimeters]

## Screw Termination, IP20

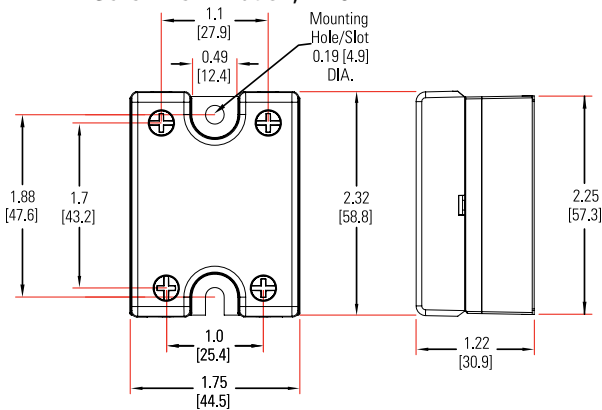



## SURGE CURRENT INFORMATION

--- Single Pulse (11)

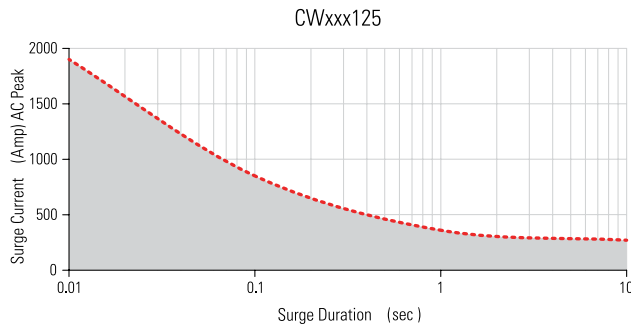
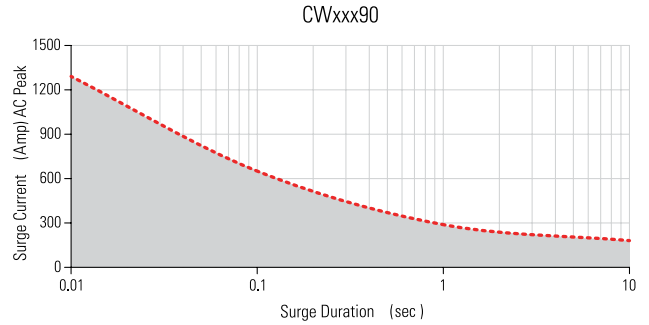
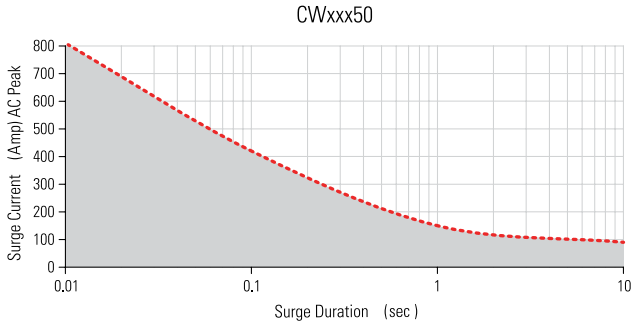
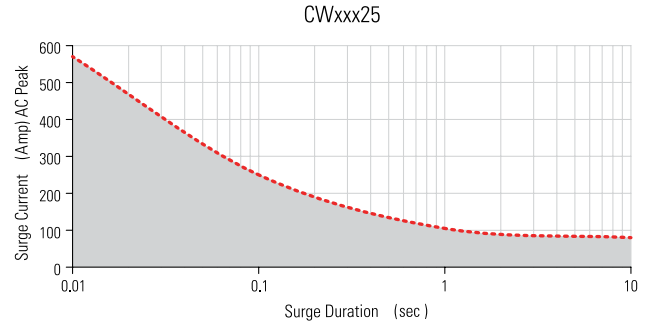
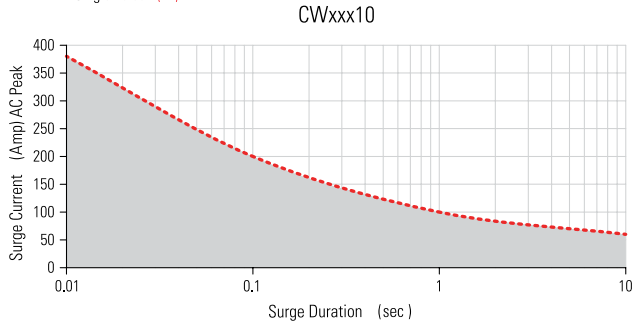

## THERMAL DERATE INFORMATION

(i) SSR metal base plate acting as heat sink, it must be exposed to free ambient air.

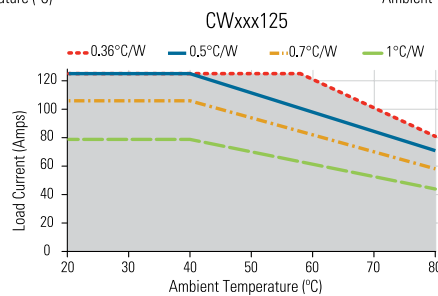
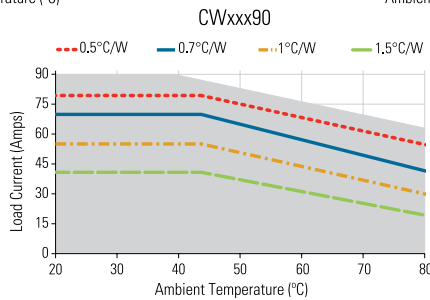
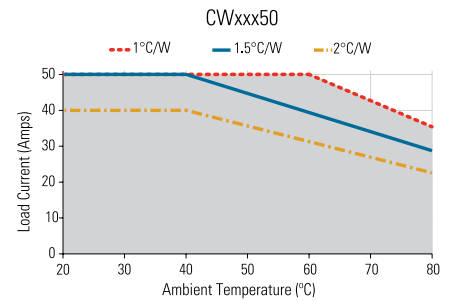
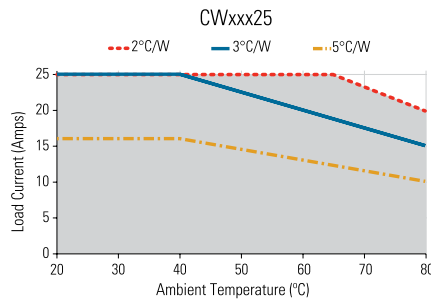
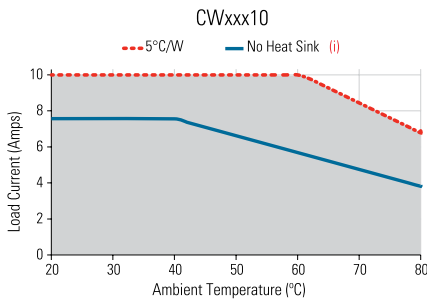



## ORDERING OPTIONS

Example : CWA2410EPH-10

Not all part number combinations are available.  
Contact Technical Support for information on the availability of a specific part number.

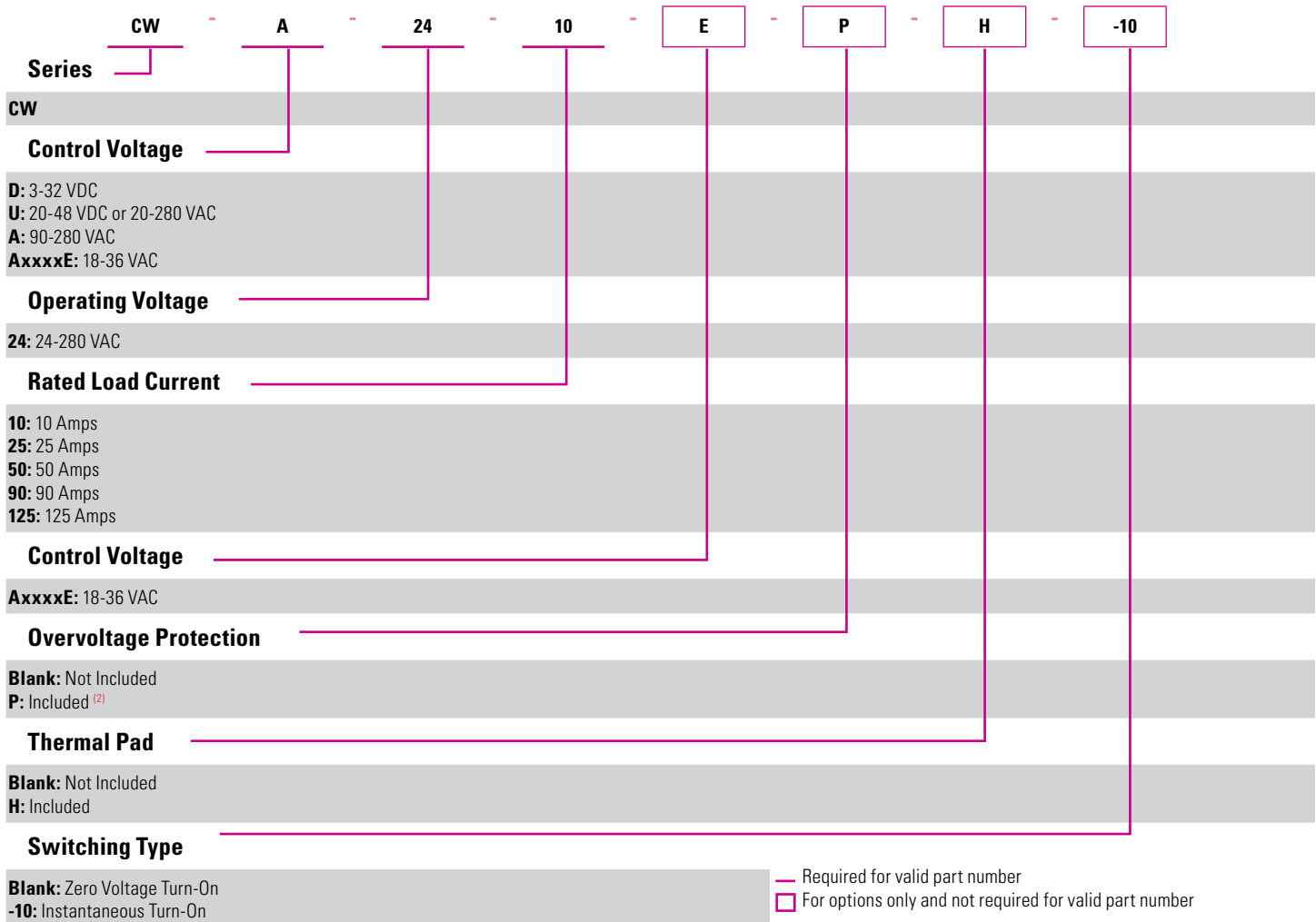

## GENERAL NOTES

- (1) All parameters at 25°C unless otherwise specified.
- (2) "P" option output will self trigger between 450-600 Vpk. Power factor 0.7 or higher, not suitable for capacitive loads.
- (3) Heat sinking required, see derating curves
- (4) For ambient temperature above 40°C the maximum control voltage must not exceed 250 VAC.
- (5) Increase minimum voltage by 1V for operations from -20 to -40°C.
- (6) Turn-on time for Instantaneous turn-on versions is 0.1 msec and 7msec for CWU models.
- (7) AC input models operating range is -20 to 80 °C.
- (8) All parameters at 50% power rating and 100% duty cycle (contact tech support for detailed report).
- (9) Load can be wired to either SSR output terminal 1 or 2.
- (10) Select P option for oversvoltage protection.
- (11) For single surge pulse Tc=25°C; Tj=125°C. For AC Output SSRs, AC Rms value of surge current equals the peak value divided by  $\sqrt{2}$  (1.414).

For additional information or specific questions, contact Technical Support

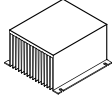
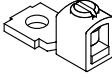
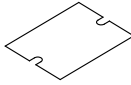

## Recommended Accessories

 Hardware Kit			 Lug Terminal	 Thermal Pad
	Heat Sink Part No.	Thermal Resistance [°C/W]		
HK1	HS501DR	5.0	TRM6	HSP-1 HSP-2
	HS301 / HS301DR	3.0		
	HS251	2.5		
	HS201 / HS201DR	2.0		
	HS202 / HS202DR	2.0		
	HS172	1.7		
	HS151 / HS151DR	1.5		
	HS122 / HS122DR	1.2		
	HS103 / HS103DR	1.0		
	HS101	1.0		
	HS073	0.7		
	HS072	0.7		
	HS053	0.5		
	HS033	0.36		
	HS023	0.25		



## AGENCY APPROVALS &amp; CERTIFICATIONS

EN60950-1: Meets the requirements of sections 1.5: 1.7: 2.9: 2.10.5.3: 4.2: 4.5: 4.7:

IEC 61000-4-2 Electrostatic Discharge Level 3

IEC 61000-4-4 Electrically Fast Transients Level 3

IEC 61000-4-5 Electrical Surges Level 3

Vibration Resistance: IEC 60068-2-6 : Amplitude Range 10-55 Hz, Displacement 0.75mm

Shock Resistance: IEC 60068-2-27 : Peak Acceleration 15g, Duration 11msec



**RISK OF MATERIAL DAMAGE AND HOT ENCLOSURE**

- The product's side panels may be hot, allow the product to cool before touching
- Follow proper mounting instructions including torque values
- Do not allow liquids or foreign objects to enter this product

**Failure to follow these instructions can result in serious injury, or equipment damage.**

**HAZARD OF ELECTRIC SHOCK, EXPLOSION OR ARCH FLASH**

- Disconnect all power before installing or working with this equipment
- Verify all connections and replace all covers before turning on power

**Failure to follow these instructions will result in death or serious injury**

Sensata Technologies, Inc. ("Sensata") data sheets are solely intended to assist designers ("Buyers") who are developing systems that incorporate Sensata products (also referred to herein as "components"). Buyer understands and agrees that Buyer remains responsible for using its independent analysis, evaluation and judgment in designing Buyer's systems and products. Sensata data sheets have been created using standard laboratory conditions and engineering practices. Sensata has not conducted any testing other than that specifically described in the published documentation for a particular data sheet. Sensata may make corrections, enhancements, improvements and other changes to its data sheets or components without notice.

Buyers are authorized to use Sensata data sheets with the Sensata component(s) identified in each particular data sheet. HOWEVER, NO OTHER LICENSE, EXPRESS OR IMPLIED, BY ESTOPPEL OR OTHERWISE TO ANY OTHER SENSATA INTELLECTUAL PROPERTY RIGHT, AND NO LICENSE TO ANY THIRD PARTY TECHNOLOGY OR INTELLECTUAL PROPERTY RIGHT, IS GRANTED HEREIN. SENSATA DATA SHEETS ARE PROVIDED "AS IS". SENSATA MAKES NO WARRANTIES OR REPRESENTATIONS WITH REGARD TO THE DATA SHEETS OR USE OF THE DATA SHEETS, EXPRESS, IMPLIED OR STATUTORY, INCLUDING ACCURACY OR COMPLETENESS. SENSATA DISCLAIMS ANY WARRANTY OF TITLE AND ANY IMPLIED WARRANTIES OF MERCHANTABILITY, FITNESS FOR A PARTICULAR PURPOSE, QUIET ENJOYMENT, QUIET POSSESSION, AND NON-INFRINGEMENT OF ANY THIRD PARTY INTELLECTUAL PROPERTY RIGHTS WITH REGARD TO SENSATA DATA SHEETS OR USE THEREOF.

All products are sold subject to Sensata's terms and conditions of sale supplied at [www.sensata.com](http://www.sensata.com) SENSATA ASSUMES NO LIABILITY FOR APPLICATIONS ASSISTANCE OR THE DESIGN OF BUYERS' PRODUCTS. BUYER ACKNOWLEDGES AND AGREES THAT IT IS SOLELY RESPONSIBLE FOR COMPLIANCE WITH ALL LEGAL, REGULATORY AND SAFETY-RELATED REQUIREMENTS CONCERNING ITS PRODUCTS, AND ANY USE OF SENSATA COMPONENTS IN ITS APPLICATIONS, NOTWITHSTANDING ANY APPLICATIONS-RELATED INFORMATION OR SUPPORT THAT MAY BE PROVIDED BY SENSATA.

Mailing Address: Sensata Technologies, Inc., 529 Pleasant Street, Attleboro, MA 02703, USA.

**CONTACT US****Americas**

+1 (877) 502 5500  
[sales.crydom@sensata.com](mailto:sales.crydom@sensata.com)  
**Europe, Middle East & Africa**  
 +44 (1202) 416170  
[ssr-info.eu@sensata.com](mailto:ssr-info.eu@sensata.com)

**Asia Pacific**

[sales.isasia@list.sensata.com](mailto:sales.isasia@list.sensata.com)  
 China +86 (21) 2306 1500  
 Japan +81 (45) 277 7117  
 Korea +82 (31) 601 2004  
 India +91 (80) 67920890  
 Rest of Asia +886 (2) 27602006  
 ext 2808