

PRODUCT CATALOG 2023-2024

Autonics

Designing a better future by connecting people and technology

Advancements in technology helped create the world we live in today, and will continue to shape the future of humanity. At Autonics, we strive to create new technology that will change the way we live tomorrow.

Technology has evolved quickly in recent years to help connect people with each other, inanimate objects, and even industries. In order to adjust to the rapidly changing manufacturing industry and requirements, Autonics continues to offer new solutions for the automation industry that will raise production efficiency, processing capabilities, manufacturing optimization, and cost reduction.

We will continue to build on our technology to help innovate production lines and bring us closer to a better tomorrow. As a partner of global industries, a provider of automations, and an architect of new industrial cultures, we are committed to building roads connecting our present to the future.

Autonics

Trusted provider of industrial automation solutions

Autonics is a leading provider of automation solutions from South Korea. We develop and manufacture a wide range of automation products which are marketed worldwide.

With nearly half a century experience in automation, over 1,600 employees in 12 international offices, and 3 manufacturing centers, we offer optimized solutions for customers across the globe.

Autonics offers a wide range of products for all three main components of automation: sensors, controllers, and actuators.

We offer automation solutions to raise production efficiency and make automation easier for users.

Our technology is trusted and adopted in various industrial applications and also applied in day-to-day automation devices, to help contribute to the improvement of quality of life. We will continue to build on our technology and solutions to make industrial processes easier, more flexible, and more convenient.



Autonics

Autonics R&D Center

* Seoul, Korea

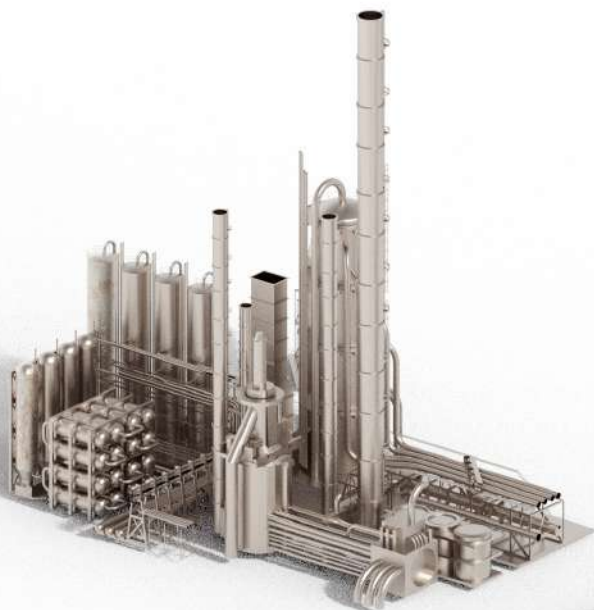

Metal / Chemical

Autonics offers optimized solutions for the industry with various products that can withstand high temperatures, shocks, vibrations and corrosion.



Logistics / Packaging

Autonics offers a diverse range of products to help improve the speed, accuracy, safety and efficiency of logistics operations and offers ideal solutions for the packaging industry with high efficiency and precision.



Oil / Gas

Autonics offers a wide range of products that can help automate processes by providing accurate and precise measurements in the industry where advanced control and measurement is required.



Marine

Autonics offers durable and reliable products and solutions with our expertise in both factory and process automation.

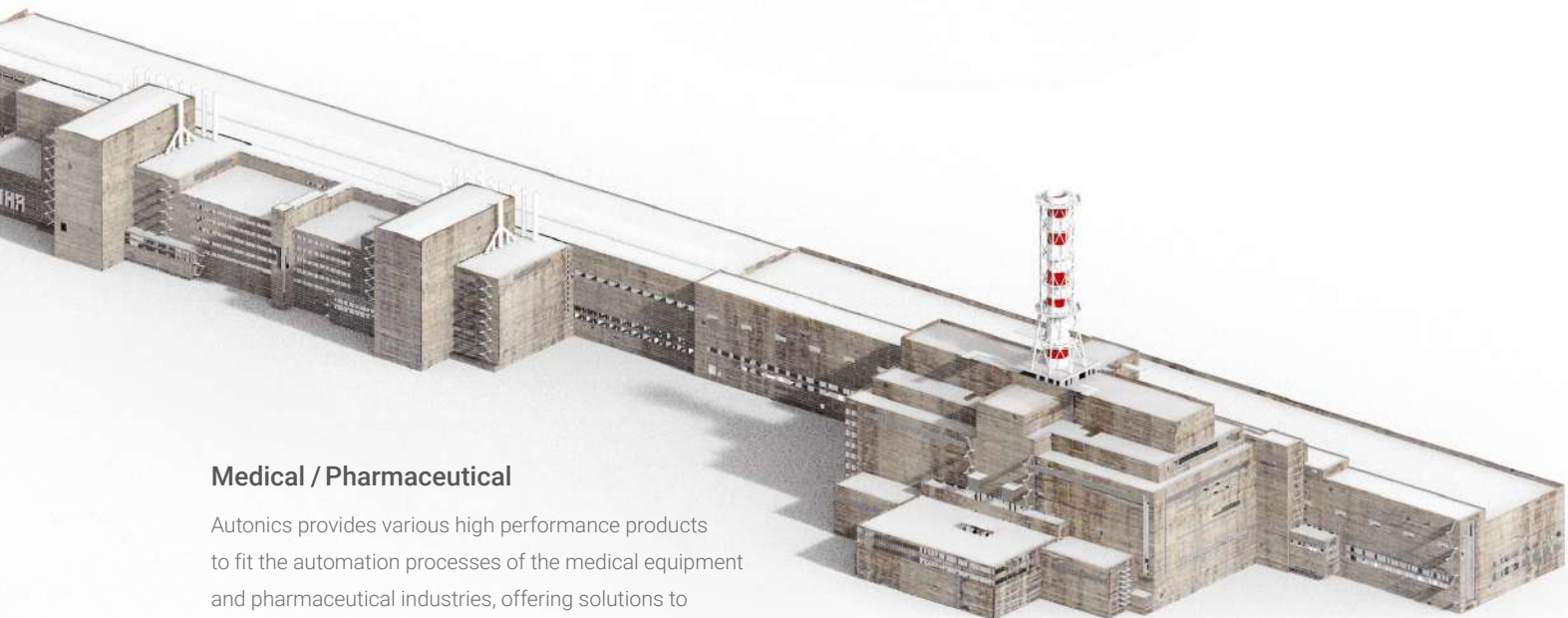

Medical / Pharmaceutical

Autonics provides various high performance products to fit the automation processes of the medical equipment and pharmaceutical industries, offering solutions to improve the quality of lives.

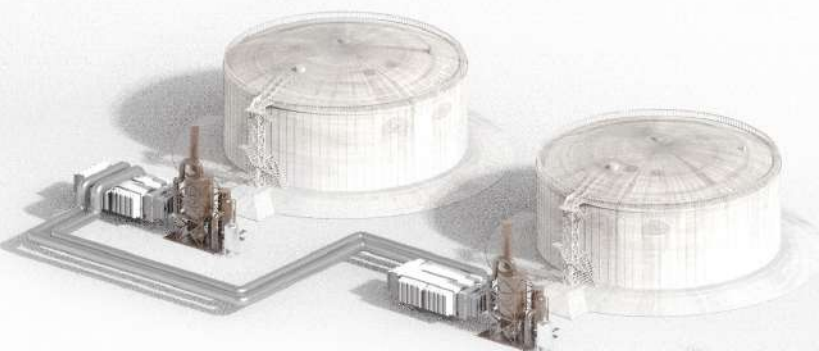

Water / Wastewater

Autonics provides various solutions to improve water safety and increase efficiency of water treatment including water purification, treatment, intake, treatment, and discharge of industrial water and wastewater processing.

Battery / Semiconductor

Autonics offers various products and solutions to improve quality and productivity in various processes including sputtering, metal layering, integrated circuit packaging, cleaning, assembly, and more.

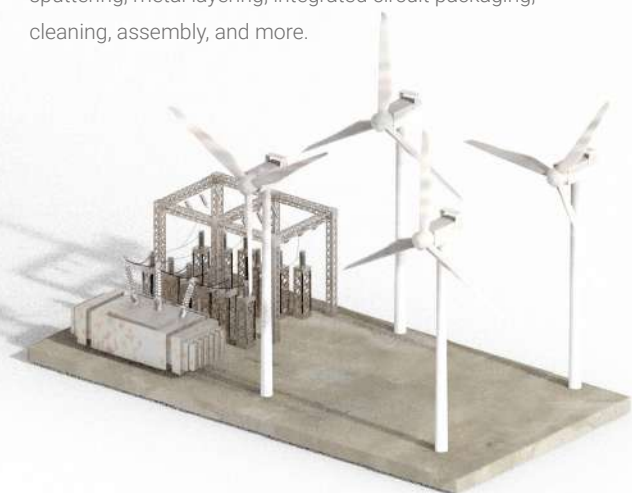

Power / Energy

Autonics provides measurement and control solutions for a wide variety of energy industries, including production and control of coal, electricity, gas, oil, and nuclear power as well as renewable energy production.

Industrial Solutions to Increase Safety, Productivity, and Efficiency

We are Committed to Providing Top Customer Experience and Satisfaction

Customer satisfaction is the foremost priority at Autonics. As a trusted business partner, Autonics provides various solution with high quality and best service to our customers. we promise differentiated services as a reliable automation partner in the global industries.

As a leading provider of automation solutions, we will continue to develop and provide new technology and products, to enhance productivity and contribute to the development of global industries and human welfare.



Authorized Service

Product replacement or refurbished products are possible, if the product is used under normal operating conditions and within the covered warranty period but cannot be repaired due to performance failures.

* Please check the global service network information for available regions.



Education / Training

Autonics offers various technical education courses, multiple seminars and webinars at various locations around the world. The training programs are designed to provide in-depth knowledge of products and automation to average users and industrial automation professionals.



e-Edu Library

e-Edu Library offers tutorial videos on various topics including Autonics product installation, parameter configuration, operation settings, and industry applications for the enhancement of our customer's knowledge and improve their productivity.



Solution Consulting

Autonics offers solution consulting through technical support for our products and technology. Customer can make appointment to request technical support or to have remote support service on technical difficulties. Live chat service availability may vary depending on countries.



Contents

Sensors	A
Field Instruments	B
Machine Vision	C
Safety	D
Controllers	E
Power Electronics	F
Motion Devices	G
Industrial Networking	H
Connectivity	I
Switches	J
Signals	K
Software	L

A. Sensors

Sensors are commonly used components in automation used to detect changes in the environment and transmit the information electronically

- A1. Photoelectric Sensors
- A2. Photomicro Sensors
- A3. Fiber Optic Sensors
- A4. Displacement Sensors
- A5. LiDAR
- A6. Door Sensors
- A7. Area Sensors
- A8. Proximity Sensors
- A9. Rotary Encoders







A1. Photoelectric Sensors

Photoelectric sensors are used to detect distance, absence or presence of objects using a light transmitter and receiver.

A1-1	Rectangular	BTS Series	W 7.2 mm Photoelectric Sensors
		BJ Series	Rectangular Photoelectric Sensors (Cable Type)
			Rectangular Photoelectric Sensors (Connector Type)
		BJX Series	Rectangular Photoelectric Sensors
		BM Series	General Photoelectric Sensors
		BMS Series	Side Sensing Photoelectric Sensors
		BY Series	Photoelectric Sensors with Synchronous Detection
		BYD Series	Photoelectric Sensors with Built-In Timer
		BH Series	Front / Side Mount Photoelectric Sensors
		BA Series	Diffuse Reflective Long-Distance Photoelectric Sensors
A1-2	Compact	BTF Series	L 3.7 mm Flat Photoelectric Sensors
		BPS Series	L 7.5 mm Flat Photoelectric Sensors
A1-3	Cylindrical	BRQ Series	Cylindrical Photoelectric Sensors (Front Sensing Type)
			Cylindrical Photoelectric Sensors (Side Sensing Type)
		BR Series	Cylindrical Photoelectric Sensors
A1-4	U-Shaped	BUM Series	4-Channel U-Shaped Photoelectric Sensors
		BUP Series	1-Channel U-Shaped Photoelectric Sensors
A1-5	AC / DC	BEN Series	Universal AC / DC Photoelectric Sensors
		BX Series	Universal AC / DC Photoelectric Sensors
A1-6	PCB Detection	BJP Series	Photoelectric Sensors for PCB Detection
A1-7	Oil-Resistant / Oil-Proof	BJR Series	Oil-Resistant Photoelectric Sensors
		BJR-F Series	Oil-Proof Photoelectric Sensors
A1-8	Color Mark	BC Series	Color Mark Photoelectric Sensors
A1-9	Liquid Level	BL Series	Liquid Level Photoelectric Sensors

W 7.2 mm

Photoelectric Sensors

BTS Series



Features

- W 7.2 mm Photoelectric Sensors
 - W 7.2 × H 18.6 × L 9.5 mm (Through-beam type)
 - W 7.2 × H 24.6 × L 10.8 mm (Retroreflective, convergent reflective type)
- Detection methods and minimum target size
 - Through-beam type (BTS1M): Ø 2 mm
 - Retroreflective type (BTS200): Ø 2 mm (sensing distance: 100 mm)
 - Convergent reflective type (BTS15/BTS30): Ø 0.15 mm (sensing distance: 10 mm)
- Maximum sensing distance: 1 m (Through-beam type)
- Operation indicator (red) and stability indicator (green) show operation status
- Stainless steel (SUS304) mounting brackets
- IP67 protection rating (IEC standard)

Specifications

Model	BTS1M-TDT□-□	BTS200-MDT□-□	BTS□-LDT□-□
Sensing type	Through-beam	Retroreflective	Convergent reflective
Sensing distance	1 m	10 to 200 mm ⁰¹⁾	5 to 15 mm ⁰²⁾ 5 to 30 mm ⁰²⁾
Sensing target	Opaque materials	≥ Ø 27 mm Opaque materials	Opaque materials, translucent materials
Min. sensing target	≥ Ø 2 mm	≥ Ø 2 mm ⁰³⁾	≥ Ø 0.15 mm ⁰⁴⁾
Hysteresis	-	-	≤ 15 % of sensing distance
Response time	≤ 1 ms		
Light source	Red LED		
Peak emission wavelength	650 nm		
Operation mode	Light ON mode / Dark ON mode model		
Indicator	Operation indicator (red), stability indicator (green)		
Approval	CE ENEC	CE ENEC	CE ENEC
Unit weight (packaged)	≈ 40 g (≈ 65 g)	≈ 25 g (≈ 45 g)	≈ 25 g (≈ 45 g)
Power supply	12-24 VDC≐ ±10 % (ripple P-P: ≤ 10%)		
Current consumption	It depends on the sensing type		
Through-beam	Emitter: ≤ 20 mA, receiver: ≤ 20 mA		
Reflective	≤ 20 mA		
Control output	NPN open collector output / PNP open collector output model		
Load voltage	≤ 26.4 VDC≐		
Load current	≤ 50 mA		
Residual voltage	NPN : ≤ 1 VDC≐, PNP : ≤ 2 VDC≐		
Protection circuit	Reverse power protection circuit, output short overcurrent protection circuit		
Insulation resistance	≥ 20 MΩ (500 VDC≐ megger)		
Noise immunity	±240 VDC≐ the square wave noise (pulse width: 1 μs) by the noise simulator		
Dielectric strength	1,000 VAC~ 50/60 Hz for 1 min		
Vibration	1.5 mm double amplitude at frequency of 10 to 55 Hz (for 1 min) in each X, Y, Z direction for 2 hours		
Shock	500 m/s ² (≈ 50 G) in each X, Y, Z direction for 3 times		
Ambient illuminance (receiver)	Sunlight: ≤ 10,000 lx, incandescent lamp: ≤ 3,000 lx		
Ambient temperature	-20 to 55 °C, storage: -30 to 70 °C (no freezing or condensation)		
Ambient humidity	35 to 85 %RH, storage: 35 to 85 %RH (no freezing or condensation)		
Protection rating	IP67 (IEC standard)		
Connection	Cable type		
Cable spec.	Ø 2.5 mm, 3-wire (emitter: 2-wire), 2 m		
Wire spec.	AWG 28 (0.08 mm, 19-core), insulator outer diameter: Ø 0.9 mm		
Material	Case: PBT, sensing part: PMMA, bracket: SUS304, bolt: SWCH10A		

01) Reflector (MS-6)

02) Non-glossy white paper 50 × 50 mm

03) Sensing distance 100 mm

04) Sensing distance 10 mm

Rectangular Photoelectric Sensors (Cable Type)

BJ Series



Features

- Compact size: W 10.6 × H 32 × L 20 mm
- IP65 protection rating (IEC standard)
- Adjuster for selecting Light ON / Dark ON mode
- Built-in sensitivity adjustment adjuster (except BJG30-DDT)
- Reverse power protection circuit, output short overcurrent protection circuit
- Mutual interference prevention function (except through-beam and BGS reflective type)
- Excellent noise immunity and minimal influence from ambient light

Specifications

Model	BJ□-TDT-□			BJ3M-PDT-□	BJ□-BDT-□		BJN□-NDT-□	
Sensing type	Through-beam			Polarized retroreflective	BGS reflective		Narrow beam reflective	
Sensing distance	7 m	10 m	15 m	3 m ⁰¹⁾	10 to 30 mm ⁰²⁾	10 to 50 mm ⁰²⁾	30 to 70 mm ⁰³⁾	70 to 130 mm ⁰³⁾
Sensing target	Opaque materials			Opaque materials	Opaque materials, translucent materials		Opaque materials, translucent materials	
Min. sensing target	≥ Ø 8 mm	≥ Ø 12 mm		≥ Ø 75 mm	-		≥ Ø 0.2 mm (copper wire)	
Hysteresis	-			-	≤ 10% of sensing distance		≤ 25% of sensing distance	≤ 20% of sensing distance
Black/white difference	-			-	≤ 10% of sensing distance		-	
Response time	≤ 1 ms			≤ 1 ms	≤ 1.5 ms		≤ 1 ms	
Light source	Red	Red	Infrared	Red	Red		Red	
Peak emission wavelength	650 nm	660 nm	850 nm	660 nm	660 nm		650 nm	
Min. spot size	-			-	≈ Ø 5.0 mm	≈ Ø 4.5 mm	≈ Ø 2.0 mm	≈ Ø 2.5 mm
Sensitivity adjustment	YES (Adjuster)			YES (Adjuster)	YES (Adjuster) ⁰⁴⁾		YES (Adjuster)	
Mutual interference prevention	-			YES	-		YES	
Operation mode	Light ON mode - Dark ON mode selectable (Adjuster)							
Indicator	Operation indicator (red), stability indicator (green), power indicator (green) ⁰⁵⁾							
Approval	CE ENEC			CE ENEC	CE ENEC		CE ENEC	
Unit weight (packaged)	≈ 90 g (≈ 115 g)			≈ 60 g (≈ 85 g)	≈ 50 g		≈ 45 g	

01) Reflector (MS-2A)

02) Non-glossy white paper 50 × 50 mm

03) Non-glossy white paper 100 × 100 mm

04) -10% of max. sensing distance, Non-glossy white paper

05) Only for the emitter

Model	BJ□-DDT-□			BJG30 -DDT
Sensing type	Diffuse reflective			Diffuse reflective
Sensing distance	100 mm ⁰¹⁾	300 mm ⁰¹⁾	1 m ⁰²⁾	15 mm ⁰³⁾ or 30 mm ⁰¹⁾
Sensing target	Opaque materials, translucent materials			Transparent glass or opaque materials, translucent materials
Hysteresis	≤ 20% of sensing distance			≤ 20% of sensing distance
Response time	≤ 1 ms			≤ 1 ms
Light source	Infrared	Red	Infrared	Infrared
Peak emission wavelength	850 nm	660 nm	850 nm	850 nm
Sensitivity adjustment	YES (Adjuster)			-
Mutual interference prevention	YES			YES
Operation mode	Light ON mode - Dark ON mode selectable (Adjuster)			Light ON
Indicator	Operation indicator (red), stability indicator (green)			Operation indicator (red), stability indicator (green)
Approval	CE EAC			CE EAC
Unit weight (packaged)	≈ 45 g (≈ 70 g)			≈ 45 g

01) Non-glossy white paper 100 × 100 mm

02) Non-glossy white paper 300 × 300 mm

03) Transparent Glass 50 × 50 mm, t = 3.0 mm

Power supply	12-24 VDC±10% (ripple P-P: ≤ 10%)
Current consumption	It depends on the sensing type
Through-beam	Emitter: ≤ 20 mA, receiver: ≤ 20 mA
Reflective	≤ 30 mA
Control output	NPN open collector output / PNP open collector output model
Load voltage	≤ 26.4 VDC±
Load current	≤ 100 mA
Residual voltage	NPN : ≤ 1 VDC±, PNP : ≤ 2.5 VDC± (BGS reflective type : ≤ 2 VDC±)
Protection circuit	Reverse power protection circuit, output short overcurrent protection circuit
Insulation resistance	≥ 20 MΩ (500 VDC± megger)
Noise immunity	±240 VDC± the square wave noise (pulse width: 1 μs) by the noise simulator
Dielectric strength	1,000 VAC~ 50/60 Hz for 1 min
Vibration	1.5 mm double amplitude at frequency of 10 to 55 Hz (for 1 min) in each X, Y, Z direction for 2 hours
Shock	500 m/s ² (≈ 50 G) in each X, Y, Z direction for 3 times
Ambient illuminance (receiver)	Sunlight: ≤ 11,000 lx, incandescent lamp: ≤ 3,000 lx
Ambient temperature	-25 to 55 °C, storage: -40 to 70 °C (no freezing or condensation)
Ambient humidity	35 to 85 %RH, storage: 35 to 85 %RH (no freezing or condensation)
Protection rating	IP65 (IEC standard)
Connection	Cable type
Cable spec.	Ø 3.5 mm, 3-wire (emitter: 2-wire), 2 m
Wire spec.	AWG24 (0.08 mm, 40-core), insulator outer diameter: Ø 1 mm
Material	Case: PC+ABS, CAP: PC, sensing part: PMMA, bracket: SUS304, bolt: SCM, nut: SCM, sleeve: Brass, Ni-plate

Rectangular Photoelectric Sensors (Connector Type)

BJ Series



Features

- Compact size: W 10.6 × H 32 × L 20 mm
- IP67 protection rating (IEC standard)
- Adjuster for selecting Light ON / Dark ON mode
- Built-in sensitivity adjustment adjuster
- Reverse power protection circuit, output short overcurrent protection circuit
- Mutual interference prevention function
- Excellent noise immunity and minimal influence from ambient light
- High performance lens with long sensing distance
- Long sensing distance :
Through-beam type 15 m,
diffuse reflective type 1 m,
polarized retroreflective type 3 m (MS-2A)
- M.S.R. (Mirror Surface Rejection) function (Polarized retroreflective type)

Specifications

Model	BJ□-TDT-C-□		BJ3M-PDT-C-□	BJ□-DDT-C-□		
Sensing type	Through-beam		Polarized retroreflective	Diffuse reflective		
Sensing distance	10 m	15 m	3 m ⁰¹⁾	100 mm ⁰²⁾	300 mm ⁰³⁾	1 m ⁰³⁾
Sensing target	Opaque materials		Opaque materials	Opaque materials, translucent materials		
Min. sensing target	≥ Ø 12 mm		≥ Ø 75 mm	-		
Hysteresis	-		-	≤ 20% of sensing distance		
Response time	≤ 1 ms		≤ 1 ms	≤ 1 ms		
Light source	Red	Infrared	Red	Infrared	Red	Infrared
Peak emission wavelength	660 nm	850 nm	660 nm	850 nm	660 nm	850 nm
Sensitivity adjustment	YES (Adjuster)		YES (Adjuster)	YES (Adjuster)		
Mutual interference prevention	-		YES	YES		
Operation mode	Light ON mode - Dark ON mode selectable (Adjuster)					
Indicator	Operation indicator (red), stability indicator (green), power indicator (green) ⁰⁴⁾					
Approval	CE EAC		CE EAC	CE EAC		
Unit weight (packaged)	≈ 20 g (≈ 45 g)		≈ 30 g (≈ 55 g)	≈ 10 g (≈ 35 g)		

01) Reflector (MS-2A)

02) Non-glossy white paper 100 × 100 mm

03) Non-glossy white paper 300 × 300 mm

04) Only for the emitter

Power supply	12-24 VDC≐ ±10 % (ripple P-P: ≤ 10%)
Current consumption	It depends on the sensing type
Through-beam	Emitter: ≤ 20 mA, receiver: ≤ 20 mA
Reflective	≤ 30 mA
Control output	NPN open collector output / PNP open collector output Model
Load voltage	≤ 26.4 VDC≐
Load current	≤ 100 mA
Residual voltage	NPN: ≤ 1 VDC≐, PNP: ≤ 2.5 VDC≐
Protection circuit	Reverse power protection circuit, output short overcurrent protection circuit
Insulation resistance	≥ 20 MΩ (500 VDC≐ megger)
Noise immunity	±240 VDC≐ the square wave noise (pulse width: 1 μs) by the noise simulator
Dielectric strength	1,000 VAC~ 50/60 Hz for 1 min
Vibration	1.5 mm double amplitude at frequency of 10 to 55 Hz (for 1 min) in each X, Y, Z direction for 2 hours
Shock	500 m/s ² (≈ 50 G) in each X, Y, Z direction for 3 times
Ambient illuminance (receiver)	Sunlight: ≤ 11,000 lx, incandescent lamp: ≤ 3,000 lx
Ambient temperature	-25 to 55 °C, storage: -40 to 70 °C (no freezing or condensation)
Ambient humidity	35 to 85 %RH, storage: 35 to 85 %RH (no freezing or condensation)
Protection rating	IP67 (IEC standard)
Connection	Connector type
Connector	M8 4-pin plug type
Material	Case: PC+ABS, CAP: PC, sensing part: PMMA, bracket: SUS304, bolt: SCM, nut: SCM, sleeve: Brass, Ni -plate

Rectangular Photoelectric Sensors

BJX Series



Features

- Long sensing distance with high quality lens:
Through-beam type 30 m,
diffuse reflective type 1 m,
polarized retroreflective type 3 m (MS-2A)
- M.S.R. (Mirror Surface Rejection) function
(Polarized retroreflective type)
- Compact size : W 11 × H 32 × L 20 mm
- Switch for selecting Light ON/Dark ON mode
- Built-in sensitivity adjustment adjuster
- Reverse power protection circuit,
output short overcurrent protection circuit
- Mutual interference prevention function
(except through-beam type)
- Excellent noise immunity and
minimal influence from ambient light
- IP65 protection rating (IEC standard)

Specifications

Model	BJX□-TDT-□-□	BJX3M-PDT-□-□	BJX□-DDT-□-□
Sensing type	Through-beam	Polarized retroreflective	Diffuse reflective
Sensing distance	10 m 15 m 30 m	3 m ⁰¹⁾	100 mm ⁰²⁾ 300 mm ⁰²⁾ 1 m ⁰³⁾
Sensing target	Opaque materials	Opaque materials	Opaque materials, translucent materials
Min. sensing target	≥ Ø 15 mm	≥ Ø 75 mm	-
Hysteresis	-	-	≤ 20 % of sensing distance
Response time	≤ 1 ms		
Light source	Red Infrared Red	Red	Infrared Red Red
Peak emission wavelength	660 nm 850 nm 660 nm	660 nm	850 nm 660 nm 660 nm
Sensitivity adjustment	YES (Adjuster)	YES (Adjuster)	YES (Adjuster)
Mutual interference prevention	-	YES	YES
Operation mode	Light ON mode - Dark ON mode selectable (Adjuster)		
Indicator	Operation indicator (yellow), stability indicator (green), power indicator (red) ⁰⁴⁾		
Approval	CE, RoHS, EAC	CE, RoHS, EAC	CE, RoHS, EAC

01) Reflector (MS-2A)

02) Non-glossy white paper 100 × 100 mm

03) Non-glossy white paper 300 × 300 mm

04) Only for the emitter

	Through-beam	Polarized retroreflective	Diffuse reflective
Unit weight (packaged)	≈ 95 g (≈ 145 g)	≈ 50 g (≈ 115 g)	≈ 50 g (≈ 100 g)
Cable type	≈ 12 g (≈ 65 g)	≈ 6 g (≈ 75 g)	≈ 6 g (≈ 60 g)
Connector type			
Power supply	10-30 VDC± ±10 % (ripple P-P: ≤ 10 %)		
Current consumption	It depends on the sensing type		
Through-beam	Emitter: ≤ 20 mA, receiver: ≤ 20 mA		
Reflective	≤ 30 mA		
Control output	NPN open collector output / PNP open collector output model		
Load voltage	≤ 30 VDC±		
Load current	≤ 100 mA		
Residual voltage	NPN: ≤ 1 VDC±, PNP: ≤ 2 VDC±		
Protection circuit	Reverse power protection circuit, output short overcurrent protection circuit		
Insulation resistance	≥ 20 MΩ (500 VDC± megger)		
Noise immunity	±240 VDC± the square wave noise (pulse width: 1 μs) by the noise simulator		
Dielectric strength	1,000 VAC~ 50/60 Hz for 1 min		
Vibration	1.5 mm double amplitude at frequency of 10 to 55 Hz (for 1 min) in each X, Y, Z direction for 2 hours		
Shock	500 m/s ² (≈ 50 G) in each X, Y, Z direction for 3 times		
Ambient illuminance (receiver)	Sunlight: ≤ 11,000 lx, incandescent lamp: ≤ 3,000 lx		
Ambient temperature	-25 to 60 °C, storage: -40 to 70 °C (no freezing or condensation) ⁰¹⁾		
Ambient humidity	35 to 85 %RH, storage: 35 to 85 %RH (no freezing or condensation)		
Protection rating	IP65 (IEC standard)		
Connection	Cable type / Connector type model		
Cable spec.	Ø 4 mm, 3-wire (Emitter: 2-wire), 2 m		
Wire spec.	AWG26 (0.52 mm, 20-core), insulator outer diameter: Ø 1 mm		
Connector	M8 4-pin plug type		
Material	Case: PC, CAP: PC, sensing part: PMMA		

01) UL approved ambient temperature: 40 °C

General

Photoelectric

Sensors

BM Series



Features

- Easy to mount at a narrow space with small size and light weight
- Built-in external sensitivity adjuster (Diffuse reflective type only)
- Easy to mount by screw type in mounting hole
- Built-in reverse power protection circuit and output short overcurrent protection circuit

Specifications

Model	BM3M-TDT	BM1M-MDT	BM200-DDT
Sensing type	Through-beam	Retroreflective	Diffuse reflective
Sensing distance	3 m	1 m ⁰¹⁾	200 mm ⁰²⁾
Sensing target	Opaque materials	Opaque materials	Opaque materials, translucent materials
Min. sensing target	≥ Ø 8 mm	≥ Ø 60 mm	-
Hysteresis	-	-	≤ 10 % of sensing distance
Response time	≤ 3 ms		
Light source	Infrared		
Peak emission wavelength	940 nm		
Sensitivity adjustment	-	-	YES (Adjuster)
Operation mode	Dark ON mode	Dark ON mode	Light ON mode (option: Dark ON mode)
Indicator	Operation indicator (red)		
Approval	CE EAC	CE EAC	CE EAC
Unit weight (packaged)	≈ 170 g (= 240 g)	≈ 105 g (= 188 g)	≈ 88 g (= 156 g)

01) Reflector (MS-2)

02) Non-glossy white paper 200 × 200 mm

Power supply	12-24 VDC= ±10 % (ripple P-P: ≤ 10 %)
Current consumption	It depends on the sensing type
Through-beam	Emitter: ≤ 45 mA, receiver: ≤ 45 mA
Reflective	≤ 40 mA
Control output	NPN open collector output
Load voltage	≤ 30 VDC=
Load current	≤ 100 mA
Residual voltage	≤ 1.5 VDC=
Protection circuit	Reverse power protection circuit, output short overcurrent protection circuit
Insulation resistance	≥ 20 MΩ (500 VDC= megger)
Noise immunity	±240 VDC= the square wave noise (pulse width: 1 μs) by the noise simulator
Dielectric strength	1,000 VAC~ 50/60 Hz for 1 min
Vibration	1.5 mm double amplitude at frequency of 10 to 55 Hz (for 1 min) in each X, Y, Z direction for 2 hours
Shock	500 m/s ² (= 50 G) in each X, Y, Z direction for 3 times
Ambient illuminance (receiver)	Sunlight: ≤ 11,000 lx, incandescent lamp: ≤ 3,000 lx
Ambient temperature	-10 to 60 °C, storage: -25 to 70 °C (no freezing or condensation)
Ambient humidity	35 to 85 %RH, storage: 35 to 85 %RH (no freezing or condensation)
Protection rating	-
Connection	Cable type
Cable spec.	Ø 4 mm, 3-wire, 2 m (Emitter: Ø 3 mm, 2-wire, 2 m)
Wire spec.	AWG22 (0.08 mm, 60-core), insulator outer diameter: Ø 1.25 mm
Material	Case: ABS, sensing part: PC (through-beam type) or Acrylic (retroreflective, diffuse reflective type), bracket: SPCC, bolt: SCM, nut: SCM

Side Sensing Photoelectric Sensors

BMS Series



Features

- Built-in reverse polarity protection circuit and output short overcurrent protection circuit
- Response time: Max. 1 ms
- Light ON / Dark ON mode selectable by control wire
- Sensitivity adjuster (except for through-beam type)

Specifications

Model	BMS5M-TDT-□	BMS2M-MDT-□	BMS300-DDT-□
Sensing type	Through-beam	Retroreflective	Diffuse reflective
Sensing distance	5 m	0.1 to 2 m ⁰¹⁾	300 mm ⁰²⁾
Sensing target	Opaque materials	Opaque materials	Opaque materials, translucent materials
Min. sensing target	≥ Ø 10 mm	≥ Ø 60 mm	-
Hysteresis	-	-	≤ 20 % of sensing distance
Response time	≤ 1 ms		
Light source	Infrared		
Peak emission wavelength	940 nm		
Sensitivity adjustment	-	YES (Adjuster)	YES (Adjuster)
Operation mode	Light ON mode - Dark ON mode selectable (control wire)		
Indicator	Operation indicator (red), power indicator (red) ⁰³⁾		
Approval	CE EAC	CE EAC	CE EAC
Unit weight	≈ 180 g	≈ 110 g	≈ 100 g

01) Reflector (MS-2)

02) Non-glossy white paper 100 × 100 mm

03) Only for the emitter

Power supply	12-24 VDC= ±10 % (ripple P-P: ≤ 10%)
Current consumption	It depends on the sensing type
Through-beam	Emitter: ≤ 50 mA, receiver: ≤ 50 mA
Reflective	≤ 45 mA
Control output	NPN open collector output / PNP open collector output model
Load voltage	≤ 30 VDC=
Load current	≤ 200 mA
Residual voltage	NPN: ≤ 1 VDC=, PNP: ≤ 2.5 VDC=
Protection circuit	Reverse power protection circuit, output short overcurrent protection circuit
Insulation resistance	≥ 20 MΩ (500 VDC= megger)
Noise immunity	±240 VDC= the square wave noise (pulse width: 1 μs) by the noise simulator
Dielectric strength	1,000 VAC~ 50/60 Hz for 1 min
Vibration	1.5 mm double amplitude at frequency of 10 to 55 Hz (for 1 min) in each X, Y, Z direction for 2 hours
Shock	500 m/s ² (≈ 50 G) in each X, Y, Z direction for 3 times
Ambient illuminance (receiver)	Sunlight: ≤ 11,000 lx, incandescent lamp: ≤ 3,000 lx
Ambient temperature	-10 to 60 °C, storage: -25 to 70 °C (no freezing or condensation)
Ambient humidity	35 to 85 %RH, storage: 35 to 85 %RH (no freezing or condensation)
Protection rating	-
Connection	Cable type
Cable spec.	Ø 5 mm, 4-wire (Emitter: 2-wire), 2 m
Wire spec.	AWG22 (0.08 mm, 60-core), insulator outer diameter: Ø 1.25 mm
Material	Case: ABS, sensing part: PC (through-beam type) or Acrylic (retroreflective, diffuse reflective type), bracket: SPCC, bolt: SCM, nut: SCM

Photoelectric Sensors

with Synchronous Detection

BY Series



Features

- Small size: W 12 × H 30 × L 16 mm
- Minimize malfunction by extraneous light by synchronizing emitter and receiver
- Reverse power protection circuit, output short overcurrent protection circuit
- Fast response speed: Max.1 ms

Specifications

Model	BY□500-TDT
Sensing type	Through-beam
Sensing distance	500 mm
Sensing target	Opaque materials
Min. sensing target	≥ Ø 5 mm
Response time	≤ 1 ms
Light source	Infrared
Peak emission wavelength	940 nm
Operation mode	Dark ON mode
Indicator	Operation indicator (red)
Approval	CE EAC
Unit weight	≈ 150 g
Power supply	12-24 VDC±10% (ripple P-P: ≤ 10%)
Current consumption	Emitter: ≤ 30 mA, receiver: ≤ 30 mA
Control output	NPN open collector output
Load voltage	≤ 30 VDC±
Load current	≤ 100 mA
Residual voltage	≤ 1 VDC±
Protection circuit	Reverse power protection circuit, output short overcurrent protection circuit
Insulation resistance	≥ 20 MΩ (500 VDC± megger)
Noise immunity	±240 VDC± the square wave noise (pulse width: 1 μs) by the noise simulator
Dielectric strength	1,000 VAC~ 50/60 Hz for 1 min
Vibration	1.5 mm double amplitude at frequency of 10 to 55 Hz (for 1 min) in each X, Y, Z direction for 2 hours
Shock	500 m/s ² (≈ 50 G) in each X, Y, Z direction for 3 times
Ambient illuminance (receiver)	Sunlight: ≤ 11,000 lx, incandescent lamp: ≤ 3,000 lx
Ambient temperature	-10 to 60 °C, storage: -25 to 70 °C (no freezing or condensation)
Ambient humidity	35 to 85 %RH, storage: 35 to 85 %RH (no freezing or condensation)
Protection rating	IP50 (IEC standard)
Connection	Cable type
Cable spec.	Ø 4 mm, 4-wire (Emitter: 3-wire), 2 m
Wire spec.	AWG22 (0.08 mm, 60-core), insulator outer diameter: Ø 1.25 mm
Material	Case: ABS, sensing part: Acrylic, bracket: SPPC, bolt: SCM, nut: SCM

Photoelectric Sensors

with Built-In Timer

BYD Series



Features

- Easy installation by compact size
- Superior detection not affected by color of target (convergent reflective type)
- Operation indicator is located on the top (BYD30-DDT-U, BYD50-DDT-U)
- Easy to adjust the response time via timer function (OFF Delay Time: 0.1 to 2 sec)
- Reverse power protection circuit, output short overcurrent protection circuit

Specifications

Model	BYD3M-TDT-□	BYD100-DDT	BYD□-DDT-□
Sensing type	Through-beam	Diffuse reflective	Convergent reflective
Sensing distance	3 m	100 mm (01)	10 to 30 mm ±10% ⁰¹⁾ 10 to 50 mm ±10% ⁰¹⁾
Sensing target	Opaque materials	Opaque materials, translucent materials	Opaque materials, translucent materials
Min. sensing target	≥ Ø 6 mm	-	-
Hysteresis	-	≤ 25 % of sensing distance	≤ 10 % of sensing distance
Response time	≤ 1 ms	Operation: ≤ 3 ms Return: ≤ 100 ms	Operation: ≤ 3 ms Return: ≤ 100 ms ⁰²⁾
Light source	Infrared	Infrared	Infrared
Sensitivity adjustment	-	YES (Adjuster)	-
Timer function	-	-	OFF delay mode: 0.1 to 2 sec (Adjuster)
Operation mode	Dark ON mode	Light ON mode	Light ON mode
Indicator	Front	Front	Front / Upper operation indicator model
	Operation indicator (red)		
Approval	CE ENEC	CE ENEC	CE ENEC
Unit weight (packaged)	≈ 80 g (≈ 105 g)	≈ 38 g (≈ 75 g)	≈ 38 g (≈ 75 g)

01) Non-glossy white paper 50 x 50 mm

02) When the timer adjuster is set to min (0.1 sec).

Power supply	12-24 VDC±10% (ripple P-P: ≤ 10%)
Current consumption	It depends on the sensing type
Through-beam	Emitter: ≤ 30 mA, receiver: ≤ 30 mA
Reflective	≤ 35 mA
Control output	Through-beam type : NPN open collector output / PNP open collector output model Diffuse reflective, convergent reflective type : NPN open collector output
Load voltage	≤ 30VDC±
Load current	Through-beam type : ≤ 100 mA Diffuse reflective, convergent reflective type : ≤ 50 mA
Residual voltage	NPN: ≤ 1 VDC±, PNP: ≤ 2.5 VDC±
Protection circuit	Reverse power protection circuit, output short overcurrent protection circuit
Insulation resistance	≥ 20 MΩ (500 VDC± megger)
Noise immunity	±240 VDC± the square wave noise (pulse width: 1 μs) by the noise simulator
Dielectric strength	1,000 VAC~ 50/60 Hz for 1 min
Vibration	1.5 mm double amplitude at frequency of 10 to 55 Hz (for 1 min) in each X, Y, Z direction for 2 hours
Shock	500 m/s ² (≈ 50 G) in each X, Y, Z direction for 3 times
Ambient illuminance (receiver)	Sunlight: ≤ 11,000 lx, incandescent lamp: ≤ 3,000 lx
Ambient temperature	-20 to 65 °C, storage: -25 to 70 °C (no freezing or condensation)
Ambient humidity	35 to 85 %RH, storage: 35 to 85 %RH (no freezing or condensation)
Protection rating	Through-beam, convergent reflective type (front operation indicator model) : IP64 (IEC standard), Others: IP50 (IEC standard)
Connection	Cable type
Cable spec.	Ø 3.5 mm, 3-wire (Emitter: 2-wire), 2 m
Wire spec.	AWG24 (0.08 mm, 40-core), insulator outer diameter: Ø 1 mm
Material	Case: ABS, sensing part: Acrylic, bracket: SPCC, bolt: SCM, nut: SCM, sleeve: Brass, Ni-plate

Front / Side Mount Photoelectric Sensors

BH Series



Features

- Easy front (M18 nut) and side (M3 bolt/nut) installation
- NPN open collector / PNP open collector simultaneous output
- Sensing distance:
Through-beam type 20 m /
Polarized retroreflective type 4 m /
Diffuse reflective type 1 m, 300 mm
- Small size: W 14 × H 34.5 × L 28 mm
- M.S.R. (Mirror Surface Rejection) function prevents malfunction from reflective objects such as metals or mirrors (polarized retroreflective type)
- Built-in sensitivity adjuster
- Light ON / Dark ON selectable by switch
- Operation indicator (red), stability indicator (green)
- Reverse power protection circuit, output short overcurrent protection circuit
- Mutual interference prevention function (except through-beam type)
- IP67 protection rating (IEC standard)

Specifications

Model	BH20M-TDT	BH4M-PDT	BH□-DDT	
Sensing type	Through-beam	Polarized retroreflective	Diffuse reflective	
Sensing distance	20 m	4 m ⁰¹⁾	300 mm ⁰²⁾	1 m ⁰³⁾
Sensing target	Opaque materials	Opaque materials	-	-
Min. sensing target	≥ Ø 20 mm	≥ Ø 75 mm	-	-
Hysteresis	-	-	≤ 20 % of sensing distance	
Response time	≤ 1 ms			
Light source	Red	Red	Red	Infrared
Peak emission wavelength	660 nm	660 nm	660 nm	850 nm
Sensitivity adjustment	YES (Adjuster)	YES (Adjuster)	YES (Adjuster)	
Mutual interference prevention	-	YES	YES	
Operation mode	Light ON mode - Dark ON mode selectable (Adjuster)			
Indicator	Operation indicator (red), stability indicator (green), power indicator (green) ⁰⁴⁾			
Approval	CE ENEC	CE ENEC	CE ENEC	
Unit weight (packaged)	≈ 120 g (≈ 190 g)	≈ 60 g (≈ 140 g)	≈ 60 g (≈ 130 g)	

01) Reflector (MS-2A)

02) Non-glossy white paper 100 × 100 mm

03) Non-glossy white paper 300 × 300 mm

04) Only for the emitter

Power supply	12-24 VDC ± 10 % (ripple P-P: ≤ 10%)
Current consumption	It depends on the sensing type
Through-beam	Emitter: ≤ 20 mA, receiver: ≤ 20 mA
Polarized retroreflective	≤ 30 mA
Diffuse reflective (300 mm)	≤ 30 mA
Diffuse reflective (1 m)	≤ 35 mA
Control output	NPN open collector - PNP open collector simultaneous output
Load voltage	≤ 26.4 VDC
Load current	≤ 100 mA
Residual voltage	NPN: ≤ 1 VDC, PNP: ≤ 2.5 VDC
Protection circuit	Reverse power protection circuit, output short overcurrent protection circuit
Insulation resistance	≥ 20 MΩ (500 VDC = megger)
Dielectric strength	1,000 VAC ~ 50/60 Hz for 1 min
Vibration	1.5 mm double amplitude at frequency of 10 to 55 Hz (for 1 min) in each X, Y, Z direction for 2 hours
Shock	500 m/s ² (≈ 50 G) in each X, Y, Z direction for 3 times
Ambient illuminance (receiver)	Sunlight: ≤ 11,000 lx, incandescent lamp: ≤ 3,000 lx
Ambient temperature	-25 to 55 °C, storage: -40 to 70 °C ⁰¹⁾ (no freezing or condensation)
Ambient humidity	35 to 85 %RH, storage: 35 to 85 %RH (no freezing or condensation)
Protection rating	IP67 (IEC standard)
Connection	Cable type
Cable spec.	Ø 4 mm, 4-wire (Emitter: 2-wire), 2.1 m
Wire spec.	AWG24 (0.08 mm, 40-core), insulator outer diameter: Ø 1.03 mm
Material	Case: PC, CAP: PC, sensing part: PMMA

01) UL approved ambient temperature 40°C

Diffuse Reflective Long-Distance Photoelectric Sensors

BA Series



Features

- Realization of long sensing distance (2 m) by special optical design
- Built-in stability indicator
- Sensitivity adjustment function
- 2 color display
- IP64 protection rating (IEC standard)

Specifications

Model	BA2M-DDT□-□
Sensing type	Diffuse reflective
Sensing distance	2 m ⁰¹⁾
Sensing target	Opaque materials, translucent materials
Hysteresis	≤ 20 % of sensing distance
Response time	≤ 1 ms
Light source	Infrared
Peak emission wavelength	850 nm
Sensitivity adjustment	YES (Adjuster)
Operation mode	Light ON mode / Dark ON mode model
Indicator	Operation indicator (red), stability indicator (Light ON: orange, Dark ON: green)
Approval	CE ENEC
Unit weight	≈ 50 g
01) Non-glossy white paper 200 × 200 mm	
Power supply	12-24 VDC± ±10 % (ripple P-P: ≤ 10%)
Current consumption	≤ 15 mA (output ON: ≤ 30 mA)
Control output	NPN open collector output / PNP open collector output model
Load voltage	≤ 26.4 VDC±
Load current	≤ 100 mA
Residual voltage	NPN: ≤ 1 VDC±, PNP: ≤ 2.5 VDC±
Protection circuit	Reverse power protection circuit, output short overcurrent protection circuit
Insulation resistance	≥ 20 MΩ (500 VDC± megger)
Noise immunity	±240 VDC± the square wave noise (pulse width: 1 μs) by the noise simulator
Dielectric strength	1,000 VAC~ 50/60 Hz for 1 min
Vibration	1.5 mm double amplitude at frequency of 10 to 55 Hz (for 1 min) in each X, Y, Z direction for 2 hours
Shock	100 m/s ² (≈ 10 G) in each X, Y, Z direction for 3 times
Ambient illuminance (receiver)	Sunlight: ≤ 11,000 lx, incandescent lamp: ≤ 3,000 lx
Ambient temperature	-25 to 55 °C, storage: -25 to 70 °C (no freezing or condensation)
Ambient humidity	35 to 85 %RH, storage: 35 to 85 %RH (no freezing or condensation)
Protection rating	IP64 (IEC standard)
Connection	Cable type
Cable spec.	∅ 3 mm, 3-wire, 2 m
Wire spec.	AWG24 (0.08 mm, 40-core), insulator outer diameter: ∅ 1 mm
Material	Case: ABS, CAP: PC, sensing part: PC, adjuster: IXEF

L 3.7 mm Flat Photoelectric Sensors

BTF Series



Features

- Ultra-thin size of only 3.7 mm
 - W 13 × H 19 × L 3.7 mm (Through-beam type)
 - W 13 × H 24 × L 3.7 mm (Diffuse reflective type, BGS reflective type)
- Detection methods and minimum target size
 - Through-beam type (BTF1M): Ø 2 mm
 - Diffuse reflective type (BTF30): Ø 0.2 mm (sensing distance: 10 mm)
 - BGS reflective type (BTF15): Ø 0.2 mm (sensing distance: 10 mm)
- BGS (background suppression) minimizes detection errors from background objects and the color or material of target objects.
- Maximum sensing distance: 1 m (Through-beam type)
- Operation indicator (red) and stability indicator (green) show operation status
- Stainless steel (SUS304) mounting brackets
- IP67 protection rating (IEC standard)

Specifications

Model	BTF1M-TDT□-□	BTF30-DDT□-□	BTF15-BDT□-□
Sensing type	Through-beam	Diffuse reflective	BGS reflective
Sensing distance	1 m	5 to 30 mm ⁰¹⁾	1 to 15 mm ⁰¹⁾
Sensing target	Opaque materials	Opaque materials, translucent materials	Opaque materials, translucent materials
Min. sensing target	≥ Ø 2 mm	≥ Ø 0.2 mm ⁰²⁾	≥ Ø 0.2 mm non-illuminated objects ⁰²⁾
Hysteresis	-	≤ 20% of sensing distance	≤ 5% of sensing distance
Black/white difference	-	-	≤ 15% of sensing distance
Response time	≤ 1 ms		
Light source	Red		
Peak emission wavelength	650 nm		
Operation mode	Light ON mode / Dark ON mode model		
Indicator	Operation indicator (red), stability indicator (green)		
Approval	CE EAC	CE EAC	CE EAC
Unit weight (packaged)	≈ 40 g (≈ 70 g)	≈ 25 g (≈ 40 g)	≈ 25 g (≈ 40 g)
01) Non-glossy white paper 50 × 50 mm			
02) Sensing distance 10 mm			
Power supply	12-24 VDC= ±10 % (ripple P-P: ≤ 10%)		
Current consumption	It depends on the sensing type		
Through-beam	Emitter: ≤ 20 mA, receiver: ≤ 20 mA		
Reflective	≤ 20 mA		
Control output	NPN open collector output / PNP open collector output model		
Load voltage	≤ 26.4 VDC=		
Load current	≤ 50 mA		
Residual voltage	NPN: ≤ 1 VDC=, PNP: ≤ 2 VDC=		
Protection circuit	Reverse power protection circuit, output short overcurrent protection circuit		
Insulation resistance	≥ 20 MΩ (500 VDC= megger)		
Noise immunity	±240 VDC= the square wave noise (pulse width: 1 μs) by the noise simulator		
Dielectric strength	1,000 VAC~ 50/60 Hz for 1 min		
Vibration	1.5 mm double amplitude at frequency of 10 to 55 Hz (for 1 min) in each X, Y, Z direction for 2 hours		
Shock	500 m/s ² (≈ 50 G) in each X, Y, Z direction for 3 times		
Ambient illuminance (receiver)	Sunlight: ≤ 10,000 lx, incandescent lamp: ≤ 3,000 lx		
Ambient temperature	-25 to 55 °C, storage: -40 to 70 °C (no freezing or condensation)		
Ambient humidity	35 to 85 %RH, storage: 35 to 85 %RH (no freezing or condensation)		
Protection rating	IP67 (IEC standard)		
Connection	Cable type		
Cable spec.	Ø 2.5 mm, 3-wire (emitter: 2-wire), 2 m		
Wire spec.	AWG 28 (0.08 mm, 19-core), insulator outer diameter: Ø 0.9 mm		
Material	Case: PBT, sensing part: PMMA, bracket: SUS304, bolt: carbon steel, sleeve: SUS304		

L 7.5 mm Flat Photoelectric Sensors

BPS Series



Features

- Easy to mount by flat type
- Realization of 3m sensing distance as small size
- IP67 protection rating (IEC standard)

Specifications

Model	BPS3M-TDT□-□
Sensing type	Through-beam
Sensing distance	3 m
Sensing target	Opaque materials
Min. sensing target	≥ Ø 5 mm
Response time	≤ 1 ms
Light source	Infrared
Peak emission wavelength	850 nm
Operation mode	Light ON mode / Dark ON mode model
Indicator	Power Indicator of emitter (red), operation indicator of receiver (red)
Approval	CE ENEC
Unit weight	≈ 66 g
Power supply	12-24 VDC±10% (ripple P-P: ≤ 10%)
Current consumption	Emitter: ≤ 20 mA, receiver: ≤ 20 mA
Control output	NPN open collector output / PNP open collector output model
Load voltage	≤ 30 VDC±
Load current	≤ 100 mA
Residual voltage	NPN: ≤ 1 VDC±, PNP: ≤ 2.5 VDC±
Protection circuit	Reverse power protection circuit, output short overcurrent protection circuit
Insulation resistance	≥ 20 MΩ (500 VDC± megger)
Noise immunity	±240 VDC± the square wave noise (pulse width: 1 μs) by the noise simulator
Dielectric strength	1,000 VAC~ 50/60 Hz for 1 min
Vibration	1.5 mm double amplitude at frequency of 10 to 55 Hz (for 1 min) in each X, Y, Z direction for 2 hours
Shock	500 m/s ² (≈ 50 G) in each X, Y, Z direction for 3 times
Ambient illuminance (receiver)	Sunlight: ≤ 11,000 lx, incandescent lamp: ≤ 3,000 lx
Ambient temperature	-25 to 65 °C, storage: -25 to 70 °C (no freezing or condensation)
Ambient humidity	35 to 85 %RH, storage: 35 to 90 %RH (no freezing or condensation)
Protection rating	IP67 (IEC standard)
Connection	Cable type
Cable spec.	Ø 3 mm, 3-wire (Emitter: 2-wire), 2 m
Wire spec.	AWG24 (0.08 mm, 40-core), insulator outer diameter: Ø 1 mm
Material	Case: PC, bolt: SCM, nut: SCM

Cylindrical Photoelectric Sensors (Front Sensing Type)

BRQ Series



Features

- Excellent noise immunity and minimal influence from ambient light
- Reverse power protection circuit, reverse output protection circuit, output short overcurrent protection circuit
- Mutual interference prevention function (except through-beam type)
- Sensitivity adjuster
- Light ON / Dark ON mode selectable by control wire
- Various materials:
Plastic, Metal (Ni-plated Brass), SUS316L
- Long sensing distance:
30 m (through-beam type)
- Body size
 - BRQT, BRQM: Standard
 - BRQP: Standard, Short body
- Protection rating
 - BRQT: IP67 (IEC standard), IP69K (DIN standard)
 - BRQM, BRQP: IP67 (IEC standard)

Specifications

Model	BRQ□□-TDT□-□-□	BRQ□3M-PDT□-□-□	BRQ□□-DDT□-□-□
Sensing type	Through-beam	Polarized retroreflective	Diffuse reflective
Sensing distance	5 m 20 m 30 m	3 m ⁰¹⁾	100 mm ⁰²⁾ 400 mm ⁰²⁾ 1 m ⁰³⁾
Sensing target	Opaque materials	Opaque materials	Opaque, translucent materials
Min. sensing target	≥ Ø 7 mm	≥ Ø 75 mm	-
Hysteresis	-	-	≤ 20 % of sensing distance
Response time	≤ 1 ms		
Light source	Red	Red	Infrared Red Red
Peak emission wavelength	660 nm	660 nm	850 nm 660 nm 660 nm
Sensitivity adjustment	YES (Adjuster)	YES (Adjuster)	YES (Adjuster)
Mutual interference prevention	-	YES	YES
Operation mode	Light ON mode - Dark ON mode selectable (Control wire)		
Indicator	Operation indicator (yellow), stability indicator (green), power indicator (red) ⁰⁴⁾		
Approval	CE SA EAC	CE SA EAC	CE SA EAC

01) Reflector (MS-2A)

02) Non-glossy white paper 100 × 100 mm

03) Non-glossy white paper 300 × 300 mm

04) Only for the emitter

Unit weight (packaged)	Material	Through-beam	Polarized retroreflective, Diffuse reflective
Cable type	SUS316L	≈ 140 g (≈ 220 g)	≈ 70 g (≈ 150 g)
	Brass, Ni-plate	≈ 140 g (≈ 220 g)	≈ 70 g (≈ 150 g)
	Plastic	≈ 110 g (≈ 160 g)	≈ 60 g (≈ 120 g)
	Plastic (short)	≈ 100 g (≈ 150 g)	≈ 50 g (≈ 120 g)
Connector type	SUS316L	≈ 50 g (≈ 160 g)	≈ 30 g (≈ 140 g)
	Brass, Ni-plate	≈ 50 g (≈ 160 g)	≈ 30 g (≈ 140 g)
	Plastic	≈ 25 g (≈ 110 g)	≈ 15 g (≈ 110 g)
	Plastic (short)	≈ 20 g (≈ 100 g)	≈ 10 g (≈ 100 g)

Power supply	10-30 VDC≐ ±10 % (ripple P-P: ≤ 10 %)
Current consumption	It depends on the sensing type
Through-beam	Emitter: ≤ 20 mA, receiver: ≤ 20 mA
Reflective	≤ 30 mA
Control output	NPN open collector output / PNP open collector output model
Load voltage	≤ 30 VDC≐
Load current	≤ 100 mA
Residual voltage	NPN: ≤ 2 VDC≐, PNP: ≤ 2 VDC≐
Protection circuit	Reverse power/output protection circuit, output short overcurrent protection circuit
Insulation resistance	≥ 20 MΩ (500 VDC≐ megger)
Noise immunity	±240 VDC≐ the square wave noise (pulse width: 1 μs) by the noise simulator
Dielectric strength	1,000 VAC~ 50/60 Hz for 1 min
Vibration	1.5 mm double amplitude at frequency of 10 to 55 Hz (for 1 min) in each X, Y, Z direction for 2 hours
Shock	500 m/s ² (≈ 50 G) in each X, Y, Z direction for 3 times
Ambient illuminance (receiver)	Sunlight: ≤ 11,000 lx, incandescent lamp: ≤ 3,000 lx
Ambient temperature	-25 to 60 °C, storage: -30 to 70 °C (no freezing or condensation)
Ambient humidity	35 to 85 %RH, storage: 35 to 85 %RH (no freezing or condensation)
Protection rating	IP67 (IEC standard), SUS316L material model: IP67 (IEC standard), IP69K (DIN standard)
Connection	Cable type / Connector type model
Cable spec.	Ø 4 mm, 4-wire, (Emitter: 2-wire), 2 m
Wire spec.	AWG26 (0.52 mm, 20-core), insulator outer diameter: Ø 1 mm
Connector	M12 4-pin plug type
Material	Case: It depends on the model. (refer to 'Ordering Information'), lens and lens cover: PMMA

Cylindrical Photoelectric Sensors

(Side Sensing Type)

BRQ Series



Features

- Excellent noise immunity and minimal influence from ambient light
- Reverse power protection circuit, reverse output protection circuit, output short overcurrent protection circuit
- Mutual interference prevention function (except through-beam type)
- Sensitivity adjuster
- Light ON / Dark ON mode selectable by control wire
- Protection rating: IP67 (IEC standard)

Specifications

Model	BRQPS□-TDTA-□-□	BRQPS3M-PDTA-□-□	BRQPS□-DDTA-□-□
Sensing type	Through-beam	Polarized retroreflective	Diffuse reflective
Sensing distance	10 m 20 m	3 m ⁰¹⁾	100 mm ⁰²⁾ 400 mm ⁰²⁾ 700 mm ⁰³⁾
Sensing target	Opaque materials	Opaque materials	Opaque, translucent materials
Min. sensing target	≥ Ø 7 mm	≥ Ø 75 mm	-
Hysteresis	-	-	≤ 20 % of sensing distance
Response time	≤ 1 ms		
Light source	Red	Red	Red
Peak emission wavelength	660 nm	660 nm	660 nm
Sensitivity adjustment	YES (Adjuster)	YES (Adjuster)	YES (Adjuster)
Mutual interference prevention	-	YES	YES
Operation mode	Light ON mode - Dark ON mode selectable (Control wire)		
Indicator	Operation indicator (yellow), stability indicator (green), power indicator (red) ⁰⁴⁾		
Approval	CE c _{UL} us ENEC	CE c _{UL} us ENEC	CE c _{UL} us ENEC

01) Reflector (MS-2S)

02) Non-glossy white paper 100 × 100 mm

03) Non-glossy white paper 200 × 200 mm

04) Only for the emitter

Unit weight (packaged)	Through-beam	Polarized retroreflective, Diffuse reflective
Cable type	≈ 120 g (≈ 170 g)	≈ 70 g (≈ 130 g)
Connector type	≈ 35 g (≈ 120 g)	≈ 25 g (≈ 120 g)
Power supply	10-30 VDC≐ ±10 % (ripple P-P: ≤ 10 %)	
Current consumption	It depends on the sensing type	
Through-beam	Emitter: ≤ 20 mA, receiver: ≤ 20 mA	
Reflective	≤ 30 mA	
Control output	NPN open collector output / PNP open collector output model	
Load voltage	≤ 30 VDC≐	
Load current	≤ 100 mA	
Residual voltage	NPN: ≤ 2 VDC≐, PNP: ≤ 2 VDC≐	
Protection circuit	Reverse power/output protection circuit, output short overcurrent protection circuit	
Insulation resistance	≥ 20 MΩ (500 VDC≐ megger)	
Noise immunity	±240 VDC≐ the square wave noise (pulse width: 1 μs) by the noise simulator	
Dielectric strength	1,000 VAC~ 50/60 Hz for 1 min	
Vibration	1.5 mm double amplitude at frequency of 10 to 55 Hz (for 1 min) in each X, Y, Z direction for 2 hours	
Shock	500 m/s ² (≈ 50 G) in each X, Y, Z direction for 3 times	
Ambient illuminance (receiver)	Sunlight: ≤ 11,000 lx, incandescent lamp: ≤ 3,000 lx	
Ambient temperature	-25 to 60 °C, storage: -30 to 70 °C (no freezing or condensation)	
Ambient humidity	35 to 85 %RH, storage: 35 to 85 %RH (no freezing or condensation)	
Protection rating	IP67 (IEC standard)	
Connection	Cable type / Connector type model	
Cable spec.	Ø 4 mm, 4-wire, (Emitter: 2-wire), 2 m	
Wire spec.	AWG26 (0.52 mm, 20-core), insulator outer diameter: Ø 1 mm	
Connector	M12 4-pin plug type	
Material	Case: PC, lens and lens cover: PMMA	

Cylindrical Photoelectric Sensors

BR Series



Features

- Superior noise resistance with digital signal processing
- High-speed response time under 1 ms
- Built-in reverse power protection circuit and output short overcurrent protection circuit
- Suitable for sensing in narrow space (narrow beam type)
- External sensitivity adjustment
- Light ON / Dark ON mode selectable by control wire
- IP66 protection rating (IEC standard)

Specifications

Model	BR□200-DDTN-□-□
Sensing type	Narrow beam reflective
Sensing distance	200 mm ⁰¹⁾
Sensing target	Opaque materials, translucent materials
Hysteresis	≤ 20 % of sensing distance
Response time	≤ 1 ms
Light source	Infrared
Peak emission wavelength	850 nm
Sensitivity adjustment	YES (Adjuster)
Operation mode	Light ON mode - Dark ON mode selectable (Control wire)
Indicator	Operation indicator (red)
Approval	CE ENEC

01) Non-glossy white paper 100 × 100 mm

Unit weight (packaged)	Metal material model	Plastic material model
Cable type	≈ 120 g (≈ 160 g)	≈ 100 g (≈ 140 g)
Connector type	≈ 50 g (≈ 90 g)	≈ 30 g (≈ 70 g)
Power supply	12-24 VDC± ±10 % (ripple P-P: ≤ 10 %)	
Current consumption	≤ 45 mA	
Control output	NPN open collector output / PNP open collector output model	
Load voltage	≤ 30 VDC±	
Load current	≤ 200 mA	
Residual voltage	NPN: ≤ 1 VDC±, PNP: ≤ 2.5 VDC±	
Protection circuit	Reverse power protection circuit, output short overcurrent protection circuit	
Insulation resistance	≥ 20 MΩ (500 VDC± megger)	
Noise immunity	±240 VDC± the square wave noise (pulse width: 1 μs) by the noise simulator	
Dielectric strength	1,000 VAC~ 50/60 Hz for 1 min	
Vibration	1.5 mm double amplitude at frequency of 10 to 55 Hz (for 1 min) in each X, Y, Z direction for 2 hours	
Shock	500 m/s ² (≈ 50 G) in each X, Y, Z direction for 3 times	
Ambient illuminance (receiver)	Sunlight: ≤ 11,000 lx, incandescent lamp: ≤ 3,000 lx	
Ambient temperature	-10 to 60 °C, storage: -25 to 75 °C (no freezing or condensation)	
Ambient humidity	35 to 85 %RH, storage: 35 to 85 %RH (no freezing or condensation)	
Protection rating	IP66 (IEC standard)	
Connection	Cable type / Connector type model	
Cable spec.	Ø 5 mm, 4-wire, 2 m	
Wire spec.	AWG22 (0.08 mm, 60-core), insulator outer diameter: Ø 1.25 mm	
Connector	M12 4-pin plug type	
Material	Case: Brass, Ni-plate (metal material model) or PA Black (plastic material model), sensing part: PC lens	

4-Channel U-Shaped Photoelectric Sensors

BUM Series



Features

- Highly reliable 4 channel detection
- High-speed response time under 1 ms
- Built-in reverse power protection circuit and output short overcurrent protection circuit
- IP65 protection rating (IEC standard)

Specifications

Model	BUM4-40D-W-4M	BUM4-40D-W-□/A	BUM4-40D-W-□/B
Sensing type	Through-beam		
Sensing distance	40 mm		
Sensing target	Opaque materials		
Min. sensing target	≥ Ø 4 mm		
Response time	≤ 1 ms		
Light source	Infrared		
Peak emission wavelength	940 nm		
Operation mode	Dark ON mode		
Indicator	Output Indicator (red), power indicator (green)		
Approval	CE ENEC		
Unit weight (packaged)	≈ 500 g (≈ 510 g)	≈ 500 g (≈ 1.5 kg)	≈ 500 g (≈ 1.5 kg)
Power supply	18-35 VDC± ±10 % (ripple P-P: ≤ 10%)		
Current consumption	≤ 50 mA		
Control output	NPN open collector output (individual 4 output)		
Load voltage	≤ 35 VDC±		
Load current	≤ 100 mA		
Residual voltage	≤ 4 VDC±		
Protection circuit	Reverse power protection circuit, output short overcurrent protection circuit		
Insulation resistance	≥ 20 MΩ (500 VDC± megger)		
Noise immunity	±240 VDC± the square wave noise (pulse width: 1 μs) by the noise simulator		
Dielectric strength	1,000 VAC~ 50/60 Hz for 1 min		
Vibration	1.5 mm double amplitude at frequency of 10 to 55 Hz (for 1 min) in each X, Y, Z direction for 2 hours		
Shock	500 m/s ² (≈ 50 G) in each X, Y, Z direction for 3 times		
Ambient illuminance (receiver)	Sunlight: ≤ 11,000 lx, incandescent lamp: ≤ 3,000 lx		
Ambient temperature	-25 to 65 °C, storage: -25 to 70 °C (no freezing or condensation)		
Ambient humidity	35 to 85 %RH, storage: 35 to 85 %RH (no freezing or condensation)		
Protection rating	IP65 (IEC standard)		
Connection	Cable type		
Cable spec.	Ø 6 mm, 8-wire, 2 m / 3 m / 4 m model		
Wire spec.	AWG22 (1.2 mm, 60-core)		
Material	Case, cover: ABS		

1-Channel U-Shaped Photoelectric Sensors

BUP Series



Features

- Various sensing distance's lineup:
30 mm, 50 mm models
- High speed response type: Max. 1 ms
- Offers the sensitivity adjustable model
- Light ON / Dark ON operation mode
selectable by control wire

Specifications

Model	BUP-□-□		BUP-□-E		BUP-□S-□	
Sensing type	Through-beam					
Sensing distance	30 mm	50 mm	30 mm	50 mm	30 mm	50 mm
Sensing target	Opaque materials					
Min. sensing target	≥ Ø 4 mm				≥ Ø 1.5 mm	
Response time	≤ 1 ms					
Light source	Infrared					
Peak emission wavelength	940 nm					
Sensitivity adjustment	Fixed				YES (Adjuster)	
Operation mode	Light ON mode - Dark ON mode selectable (Control wire)					
Indicator	Operation indicator (red), power indicator (green)					
Approval	CE ENEC		CE		CE ENEC	
Unit weight (packaged)	≈ 85 g (≈ 120 g)	≈ 115 g (≈ 160 g)	≈ 60 g (≈ 95 g)	≈ 90 g (≈ 125 g)	≈ 85 g (≈ 120 g)	≈ 115 g (≈ 160 g)
Power supply	12-24 VDC≒ ±10 % (ripple P-P: ≤ 10%)					
Current consumption	≤ 30 mA					
Control output	NPN open collector output / PNP open collector output model					
Load voltage	≤ 30 VDC≒					
Load current	≤ 200 mA					
Residual voltage	NPN: ≤ 1 VDC≒, PNP: ≤ 2.5 VDC≒					
Protection circuit	Reverse power protection circuit, output short overcurrent protection circuit					
Insulation resistance	≥ 20 MΩ (500 VDC≒ megger)					
Noise immunity	±240 VDC≒ the square wave noise (pulse width: 1 μs) by the noise simulator					
Dielectric strength	1,000 VAC~ 50/60 Hz for 1 min					
Vibration	1.5 mm double amplitude at frequency of 10 to 55 Hz (for 1 min) in each X, Y, Z direction for 2 hours					
Shock	500 m/s ² (≈ 50 G) in each X, Y, Z direction for 3 times					
Ambient illuminance (receiver)	Sunlight: ≤ 11,000 lx, incandescent lamp: ≤ 3,000 lx					
Ambient temperature	Fixed sensitivity model: -25 to 65 °C, storage: -25 to 70 °C (no freezing or condensation) Sensitivity adjustable model: -10 to 60 °C, storage: -25 to 70 °C (no freezing or condensation)					
Ambient humidity	35 to 85 %RH, storage: 35 to 85 %RH (no freezing or condensation)					
Protection rating	Fixed sensitivity model: IP66 (IEC standard) Sensitivity adjustable model: IP50 (IEC standard)					
Connection	Cable type, cable connector type					
Cable spec.	Cable type: Ø 4 mm, 4-wire, 2 m Cable connector type: Ø 4 mm, 4-wire, 0.5 m					
Wire spec.	AWG22 (0.08 mm, 60-core), insulator outer diameter: Ø 1.25 mm					
Connector	5-pin socket type					
Material	Case: ABS, CAP: PC					

Universal AC / DC Photoelectric Sensors

BEN Series



Features

- Small and power supply built-in type
- Easy installation with indicators on product
- Light ON / Dark ON mode selectable by switch
- Status and output indication
- Built-in IC photo diode for disturbing light and electrical noise

Specifications

Model	BEN10M-T □	BEN5M-M □	BEN3M-P □	BEN300-D □
Sensing type	Through-beam	Retroreflective	Polarized retroreflective	Diffuse reflective
Sensing distance	10 m	0.1 to 5 m ⁰¹⁾	0.1 to 3 m ⁰¹⁾	300 mm ⁰²⁾
Sensing target	Opaque materials	Opaque materials	Opaque materials	Opaque, translucent materials
Min. sensing target	≥ Ø 16 mm	≥ Ø 60 mm	≥ Ø 60 mm	-
Hysteresis	-	-	-	≤ 20 % of sensing distance
Response time	AC/DC power, relay contact output model: ≤ 20 ms DC power, solid state (transistor) output model: ≤ 1 ms			
Light source	Infrared	Infrared	Red	Infrared
Peak emission wavelength	850 nm	940 nm	660 nm	940 nm
Sensitivity adjustment	-	YES (Adjuster)	YES (Adjuster)	YES (Adjuster)
Operation mode	Light ON mode - Dark ON mode selectable (Adjuster)			
Indicator	Operation indicator (red), stability indicator (green), power indicator (red) ⁰³⁾			
Approval	CE [REDACTED]			
Unit weight (AC/DC power)	≈ 354 g	≈ 208 g	≈ 208 g	≈ 195 g
Unit weight (DC power)	≈ 342 g	≈ 200 g	≈ 200 g	≈ 187 g

01) Reflector (MS-2)

02) Non-glossy white paper 100 × 100 mm

03) Only for the emitter

Output method	AC/DC power, relay contact output	DC power, solid state (transistor) output
Power supply	24-240 VAC ~ ± 10 % 50/60 Hz 24-240 VDC = ± 10 % (ripple P-P: ≤ 10 %)	12-24 VDC = ± 10 % (ripple P-P: ≤ 10 %)
Power / current consumption	≤ 4 VA	It depends on the sensing type
Through-beam	-	Emitter: ≤ 50 mA, receiver: ≤ 50 mA
Reflective	-	≤ 50 mA
Control output	Relay contact output	NPN open collector - PNP open collector simultaneous output
Contact capacity	250 VAC ~ 3 A of resistance load, 30 VDC = 3 A of resistance load	-
Contact composition	1c	-
Relay life cycle	Mechanical: ≥ 50,000,000 Electrical: ≥ 100,000	-
Load voltage	-	≤ 30 VDC =
Load current	-	≤ 200 mA
Residual voltage	-	NPN: ≤ 1 VDC =, PNP: ≤ 2.5 VDC =
Protection circuit	-	Reverse power protection circuit, output short overcurrent protection circuit
Insulation resistance	≥ 20 MΩ (500 VDC = megger)	
Insulation type	Double or strong insulation (dielectric voltage between the measured input and the power: 1 kV)	-
Noise immunity	± 1,000 VDC = the square wave noise (pulse width: 1 μs) by the noise simulator	± 240 VDC = the square wave noise (pulse width: 1 μs) by the noise simulator

Dielectric strength	1,000 VAC~ 50/60 Hz for 1 min
Vibration	1.5 mm double amplitude at frequency of 10 to 55 Hz (for 1 min) in each X, Y, Z direction for 2 hours
Vibration (malfunction)	1.5 mm double amplitude at frequency of 10 to 55 Hz (for 1 min) in each X, Y, Z direction for 10 min -
Shock	500 m/s ² (≈ 50 G) in each X, Y, Z direction for 3 times
Shock (malfunction)	100 m/s ² (≈ 10 G) in each X, Y, Z direction for 3 times -
Ambient illuminance (receiver)	Sunlight: ≤ 11,000 lx, incandescent lamp: ≤ 3,000 lx
Ambient temperature	-20 to 65 °C, storage: -20 to 70 °C (no freezing or condensation)
Ambient humidity	35 to 85 %RH, storage: 35 to 85 %RH (no freezing or condensation)
Protection rating	IP50 (IEC standard)
Connection	Cable type
Cable spec.	∅ 5 mm, Emitter: 2-wire, AC/DC power: 5-wire, DC power: 4-wire, 2 m
Wire spec.	AWG22 (0.08 mm, 60-core), insulator outer diameter: ∅ 1.25 mm
Material	Case and case cover: heat resistant ABS, sensing part: PC (polarized retroreflective: PMMA)

Universal AC / DC Photoelectric Sensors

BX Series



Features

- Built-in sensitivity adjuster
- Timer function (built-in timer model)
 - ON Delay, OFF Delay, One-shot Delay
- NPN / PNP open collector simultaneous output (DC power Type)
- Self-diagnosis function (green lights up in the stable level)
- Built-in reverse power protection circuit and output short overcurrent protection circuit
- Wide power supply range:
Universal 24-240 VDC \approx / 24-240 VAC \sim
- IP66 protection rating (IEC standard)

Specifications

Model	BX15M-T□-□	BX5M-M□-□	BX3M-P□-□	BX700-D□-□
Sensing type	Through-beam	Retroreflective	Polarized retroreflective	Diffuse reflective
Sensing distance	15 m	0.1 to 5 m ⁰¹⁾	0.1 to 3 m ⁰²⁾	700 mm ⁰³⁾
Sensing target	Opaque materials	Opaque materials	Opaque materials	Opaque, translucent materials
Min. sensing target	≥ Ø 15 mm	≥ Ø 60 mm	≥ Ø 60 mm	-
Hysteresis	-	-	-	≤ 20 % of sensing distance
Response time	AC/DC power, relay contact output model: ≤ 20 ms DC power, solid state (transistor) output model: ≤ 1 ms			
Light source	Infrared	Infrared	Red	Infrared
Peak emission wavelength	850 nm	940 nm	660 nm	940 nm
Sensitivity adjustment	YES (Adjuster)	YES (Adjuster)	YES (Adjuster)	YES (Adjuster)
Timer mode ⁰⁴⁾	OFF, ON Delay, OFF Delay, One Shot Delay mode selectable (Switch): 0.1 to 5 sec (Adjuster)			
Operation mode	Light ON mode - Dark ON mode selectable (Switch)			
Indicator	Operation indicator (yellow), self-diagnosis indicator (green), power indicator (yellow) ⁰⁵⁾			
Approval	CE ENEC	CE ENEC	CE ENEC	CE ENEC
Unit weight	Based on the standard model, timer model: weight + 1 g			
AC/DC power	≈ 225 g	≈ 130 g	≈ 148 g	≈ 115 g
DC power	≈ 211 g	≈ 123 g	≈ 141 g	≈ 116 g

01) Reflector (MS-2)

02) Reflector (MS-3)

03) Non-glossy white paper 200 × 200 mm

04) Only for the timer model

05) Only for the emitter

Output method	AC/DC power, relay contact output	DC power, Transistor solid state output
Power supply	24-240 VAC \sim ± 10 % 50/60 Hz 24-240 VDC \approx ± 10 % (ripple P-P: ≤ 10 %)	12-24 VDC \approx ± 10 % (ripple P-P: ≤ 10 %)
Power / current consumption	≤ 3 VA	It depends on the sensing type
Through-beam		Emitter: ≤ 50 mA, receiver: ≤ 50 mA
Reflective		≤ 50 mA
Control output	Relay contact output	NPN open collector - PNP open collector simultaneous output
Contact capacity	250 VAC \sim 3 A of resistance load, 30 VDC \approx 3 A of resistance load	-
Contact composition	1c	
Relay life cycle	Mechanical: ≥ 50,000,000 Electrical: ≥ 100,000	
Load voltage	-	≤ 30 VDC \approx
Load current		≤ 200 mA
Residual voltage		NPN: ≤ 1 VDC \approx , PNP: ≤ 2.5 VDC \approx
Self-diagnosis output	-	NPN open collector output ⁰¹⁾
Protection circuit	-	Reverse power protection circuit, output short overcurrent protection circuit

01) Load voltage: ≤ 30 VDC \approx , load current: ≤ 50 mA, residual voltage: ≤ 1 VDC \approx (50 mA), ≤ 0.4 VDC \approx (16 mA)

Insulation resistance	≥ 20 MΩ (500 VDC≐ megger)	
Insulation type	Double or strong insulation (dielectric voltage between the measured input and the power : 1.5 kV)	-
Noise immunity	± 1,000 VDC≐ the square wave noise (pulse width: 1 μs) by the noise simulator	±240 VDC≐ the square wave noise (pulse width: 1 μs) by the noise simulator
Dielectric strength	1,500 VAC~ 50/60 Hz for 1 min	
Vibration	1.5 mm double amplitude at frequency of 10 to 55 Hz (for 1 min) in each X, Y, Z direction for 2 hours	
Vibration (malfunction)	1.5 mm double amplitude at frequency of 10 to 55 Hz (for 1 min) in each X, Y, Z direction for 10 min	
Shock	500 m/s ² (≈ 50 G) in each X, Y, Z direction for 3 times	
Shock (malfunction)	100 m/s ² (≈ 10 G) in each X, Y, Z direction for 3 times	
Ambient illuminance (receiver)	Sunlight: ≤ 11,000 lx, incandescent lamp: ≤ 3,000 lx	
Ambient temperature	-20 to 55 °C, storage: -25 to 70 °C (no freezing or condensation)	
Ambient humidity	35 to 85 %RH, storage: 35 to 85 %RH (no freezing or condensation)	
Protection rating	IP66 (IEC standard)	
Connection	Terminal type	
Material	Case, lens cover: PC, sensing part: Acrylic, bracket: SPCC, bolt: SCM, nut: SCM	

Photoelectric Sensors

for PCB Detection

BJP Series



Features

- 30 mm × 3 mm of rectangular light beam (at 30 mm distance) provides accurate detection of PCBs regardless of holes, incomplete fabrication, protrusions, or intrusions on the boards.
- Background suppression (BGS) sensing method allows stable detection regardless of the color, texture or surface of the background object.
- Sensing distance: 10 to 100 mm (adjustable distance: 20 to 100 mm)
- Switch for selecting Light ON / Dark ON mode
- Reverse power protection circuit, output short overcurrent protection circuit
- IP65 protection rating (IEC standard)

Specifications

Model	BJP100-BDT-□
Sensing type	BGS reflective
Sensing distance	10 to 100 mm ⁰¹⁾ (at sensing distance: 100 mm)
Sensing target	Opaque materials
Sensing distance setting	20 to 100 mm ⁰¹⁾
Hysteresis	≤ 10 % of setting distance ⁰¹⁾
Response time	≤ 1.5 ms
Light source	Red
Peak emission wavelength	660 nm
Beam spot size	W 3 × L 30 mm (at sensing distance: 30 mm)
Operation mode	Light ON mode - Dark ON mode selectable (Adjuster)
Indicator	Operation indicator (red), stability indicator (green)
Approval	CE ENEC
Unit weight (packaged)	≈ 50 g (≈ 105 g)
<small>01) Non-glossy white paper 100 × 100 mm</small>	
Power supply	12-24 VDC≐ ±10 % (ripple P-P: ≤ 10 %)
Current consumption	≤ 30 mA
Control output	NPN open collector output / PNP open collector output model
Load voltage	≤ 26.4 VDC≐
Load current	≤ 100 mA
Residual voltage	NPN: ≤ 1 VDC≐, PNP: ≤ 2 VDC≐
Protection circuit	Reverse power protection circuit, output short overcurrent protection circuit
Insulation resistance	≥ 20 MΩ (500 VDC≐ megger)
Noise immunity	±240 VDC≐ the square wave noise (pulse width: 1 μs) by the noise simulator
Dielectric strength	1,000 VAC~ 50/60 Hz for 1 min
Vibration	1.5 mm double amplitude at frequency of 10 to 55 Hz (for 1 min) in each X, Y, Z direction for 2 hours
Shock	500 m/s ² (≈ 50 G) in each X, Y, Z direction for 3 times
Ambient illuminance (receiver)	Sunlight: ≤ 10,000 lx, incandescent lamp: ≤ 3,000 lx
Ambient temperature	-25 to 55 °C, storage: -40 to 70°C (no freezing or condensation)
Ambient humidity	35 to 85 %RH, storage: 35 to 85 %RH (no freezing or condensation)
Protection rating	IP65 (IEC standard)
Connection	Cable type
Cable spec.	∅ 3.5 mm, 3-wire, 2 m
Wire spec.	AWG24 (0.08 mm, 40-core), insulator outer diameter: ∅ 1 mm
Material	Case: PC+ABS, CAP: PC, sensing part: PMMA

Oil-Resistant Photoelectric Sensors

BJR Series



Features

- Long sensing distance with lens of high performance: Through-beam type 15 m, diffuse reflective type 1 m, polarized retroreflective type 3 m (MS-2S)
- M.S.R. (Mirror Surface Rejection) function (Polarized retroreflective type)
- Compact size: W 11 × H 32 × L 20 mm
- Light ON / Dark ON operation mode switch
- Built-in sensitivity adjustment adjuster
- Reverse power protection circuit and output short overcurrent protection circuit
- Mutual interference prevention function (except through-beam type)
- Excellent noise immunity and minimal influence from ambient light
- Stronger in the environment with full of cutting fluid or lubricating oil (optimized for automobile and machine tool industry)
- IP67 protection rating (IEC standard), IP67G oil resistance protection rating (JEM standard)

Specifications

Model	BJR15M-TDT-□-□	BJR3M-PDT-□-□	BJR□-DDT-□-□	
Sensing type	Through-beam	Polarized retroreflective	Diffuse reflective	
Sensing distance	15 m	3 m ⁰¹⁾	100 mm ⁰²⁾	1 m ⁰³⁾
Sensing target	Opaque materials	Opaque materials	Opaque materials, translucent materials	
Min. sensing target	≥ Ø 12 mm	≥ Ø 75 mm	-	-
Hysteresis	-	-	≤ 20 % of sensing distance	
Response time	≤ 1 ms			
Light source	Infrared	Red	Infrared	Red
Peak emission wavelength	850 nm	660 nm	850 nm	660 nm
Sensitivity adjustment	YES (Adjuster)	YES (Adjuster)	YES (Adjuster)	
Mutual interference prevention	-	YES	YES	
Operation mode	Light ON mode - Dark ON mode selectable (Adjuster)			
Indicator	Operation indicator (yellow), stability indicator (green), power indicator (red) ⁰⁴⁾			
Approval	CE	CE	CE	

01) Reflector (MS-2S)

02) Non-glossy white paper 100 × 100 mm

03) Non-glossy white paper 300 × 300 mm

04) Only for the emitter

Unit weight (packaged)	Through-beam	Polarized retroreflective	Diffuse reflective
Cable type	≈ 95 g (≈ 145 g)	≈ 50 g (≈ 115 g)	≈ 50 g (≈ 100 g)
Cable connector type	≈ 55 g (≈ 105 g)	≈ 30 g (≈ 95 g)	≈ 30 g (≈ 80 g)
Power supply	10-30 VDC≐ ±10 % (ripple P-P: ≤ 10 %)		
Current consumption	It depends on the sensing type		
Through-beam	Emitter: ≤ 20 mA, receiver: ≤ 20 mA		
Reflective	≤ 30 mA		
Control output	NPN open collector output / PNP open collector output model		
Load voltage	≤ 30 VDC≐		
Load current	≤ 100 mA		
Residual voltage	NPN: ≤ 1 VDC≐, PNP: ≤ 2 VDC≐		
Protection circuit	Reverse power protection circuit, output short overcurrent protection circuit		
Insulation resistance	≥ 20 MΩ (500 VDC≐ megger)		
Noise immunity	±240 VDC≐ the square wave noise (pulse width: 1 μs) by the noise simulator		
Dielectric strength	1,000 VAC~ 50/60 Hz for 1 min		
Vibration	1.5 mm double amplitude at frequency of 10 to 55 Hz (for 1 min) in each X, Y, Z direction for 2 hours		
Shock	500 m/s ² (≈ 50 G) in each X, Y, Z direction for 3 times		
Ambient illuminance (receiver)	Sunlight: ≤ 11,000 lx, incandescent lamp: ≤ 3,000 lx		
Ambient temperature	-25 to 60 °C, storage: -40 to 70°C (no freezing or condensation)		
Ambient humidity	35 to 85 %RH, storage: 35 to 85 %RH (no freezing or condensation)		
Protection rating	IP67 (IEC standard), IP67G (JEM standard)		
Connection	Cable type / Cable connector type model		
Cable spec.	Ø 4 mm, 3-wire (emitter: 2-wire), cable type: 2 m, cable connector type: 300 mm		
Wire spec.	AWG26 (0.52 mm, 20-core), insulator outer diameter: Ø 1 mm		
Connector	M12 4-pin plug type		
Material	Case: ABS, CAP: PA12, sensing part: PMMA		

Color Mark

Photoelectric

Sensors

BC Series



Features

- Outstanding color matching accuracy
 - R.G.B light emitting diodes and 12-bit resolution
 - 2 detection modes (color only / color + intensity)
 - 3-step sensitivity adjustment for each mode (fine, normal, rough)
- External light interference reduction minimizes errors and allows stable detection
- Check reference color with teaching indicator
- Operation indicator (red), stability indicator (green), timer indicator (orange)
- Configure operation functions with external input from wiring
- W 1.24 × L 6.7 mm spot size for detection of tiny targets and color marks
- IP67 protection rating (IEC standard)

Specifications

Model	BC15-LDT-C-□
Sensing type	Convergent reflective
Sensing distance	15 mm ± 2 mm
Sensing target	Opaque materials, translucent materials
Hysteresis	≤ 20 % of sensing distance (may vary by sensing mode or sensitivity)
Response time	≤ 500 μs
Light source	Full Color (Red, Green, Blue)
Min. spot size	W 1.24 × L 6.7 mm
Sensing mode	C mode (color only) - C+I mode (color + intensity) selectable (SET key or SET cable)
Sensitivity adjustment	YES (SET key or SET cable)
Operation mode	Color match (Normally Open) - Color mismatch (Normally Closed) mode selectable (Adjuster)
Teaching	YES
Timer	OFF-delay mode: 40 ms
Indicator	Operation indicator (red), stability indicator (green), teaching indicator (full color), timer indicator (orange)
Approval	CE ENEC
Unit weight (packaged)	≈ 14 g (≈ 80 g)
Power supply	12-24 VDC± ±10 % (ripple P-P: ≤ 10 %)
Current consumption	≤ 30 mA
Control output	NPN open collector output / PNP open collector output model
Load voltage	≤ 30 VDC±
Load current	≤ 100 mA
Residual voltage	NPN: ≤ 1 VDC±, PNP: ≤ 2.5 VDC±
Protection circuit	Reverse power protection circuit, output short overcurrent protection circuit
Insulation resistance	≥ 20 MΩ (500 VDC± megger)
Noise immunity	±240 VDC± the square wave noise (pulse width: 1 μs) by the noise simulator
Dielectric strength	1,000 VAC~ 50/60 Hz for 1 min
Vibration	1.5 mm double amplitude at frequency of 10 to 55 Hz (for 1 min) in each X, Y, Z direction for 2 hours
Shock	500 m/s ² (≈ 50 G) in each X, Y, Z direction for 3 times
Ambient illuminance (receiver)	Incandescent lamp: ≤ 3,000 lx
Ambient temperature	-10 to 55 °C, storage: -25 to 75 °C (no freezing or condensation)
Ambient humidity	35 to 85 %RH, storage: 35 to 85 %RH (no freezing or condensation)
Protection rating	IP67 (IEC standard)
Connection	Connector type
Connector	M12 4-pin plug type
Material	Case: PC, sensing part: Acrylic, bracket: SUS304, bolt: Carbon Steel

Liquid Level Photoelectric Sensors

BL Series



Features

- Detects liquid in a transparent / semitransparent pipe diameter Ø6 to 13 mm, thickness 1 mm
- Compact size: W 23 × H 14 × L 13 mm
- Selectable Light ON / Dark ON mode by operation mode switching button
- Easy to check operation status by operation mode indicator [green (Light ON: on, Dark ON: off)], operation indicator [red]
- Built-in reverse power protection circuit and output short overcurrent protection circuit
- Protection bracket (sold separately) helps to minimize the effects of external environment [Ø 12.7 mm (1/2 inch) pipes]
- IP64 protection rating (IEC standard)

Specifications

Model	BL13-TDT-□
Sensing type	Through-beam
Applicable pipe	Transparent pipes in 1mm thickness (FEP (fluoroplastic) or with equivalent transparency) Using binding band: Ø 6 to 13 mm Using protection bracket: Ø 12.7 mm (1/2 inch)
Sensing target	Liquid in a pipe ⁰¹⁾
Response time	≤ 2 ms
Light source	Infrared
Peak emission wavelength	950 nm
Operation mode	Light ON mode - Dark ON mode selectable (Button)
Indicator	Operation indicator (red), operation mode indicator (green)
Approval	CE ENEC
Unit weight (packaged)	≈ 13 g (≈ 50 g)
<small>01) This may not detect the liquid with low transparent, with high viscosity, or with floating matters.</small>	
Power supply	12-24 VDC= ±10 % (ripple P-P: ≤ 10 %)
Current consumption	≤ 30 mA
Control output	NPN open collector output / PNP open collector output model
Load voltage	≤ 30 VDC=
Load current	≤ 100 mA
Residual voltage	NPN: ≤ 1 VDC=, PNP: ≤ 1 VDC=
Protection circuit	Reverse power protection circuit, output short overcurrent protection circuit
Insulation resistance	≥ 20 MΩ (500 VDC= megger)
Noise immunity	±240 VDC= the square wave noise (pulse width: 1 μs) by the noise simulator
Dielectric strength	1,000 VAC~ 50/60 Hz for 1 min (between all terminals and case)
Vibration	1.5 mm double amplitude at frequency of 10 to 55 Hz (for 1 min) in each X, Y, Z direction for 2 hours
Shock	500 m/s ² (≈ 50 G) in each X, Y, Z direction for 3 times
Ambient illuminance (receiver)	Sunlight: ≤ 3,000 lx, incandescent lamp: ≤ 3,000 lx
Ambient temperature	10 to 55 °C, storage: -25 to 65 °C (no freezing or condensation)
Ambient humidity	35 to 85 %RH, storage: 35 to 85 %RH (no freezing or condensation)
Protection rating	IP64 (IEC standard)
Connection	Cable type
Cable spec.	Ø 2.5 mm, 3-wire, 1 m
Wire spec.	AWG28 (0.08 mm, 19-core), insulator outer diameter: Ø 0.9 mm
Material	Case: PC



A2. Photomicro Sensors

Photomicro sensors are compact sized photoelectric sensors with built-in amplifiers used to detect presence of mechanical parts in equipments.

A2-1	Through-Beam	BS3 Series	Groove-Depth 6.5 mm Photomicro Sensors
		BS4 Series	Groove-Depth 6.5 mm Photomicro Sensors with Built-In Connector
		BS5 Series	Groove-Depth 9 mm Photomicro Sensors
A2-2	Push-Button	BS5-P Series	Push-Button Type Photomicro Sensors

Groove-Depth 6.5 mm

Photomicro Sensors

BS3 Series

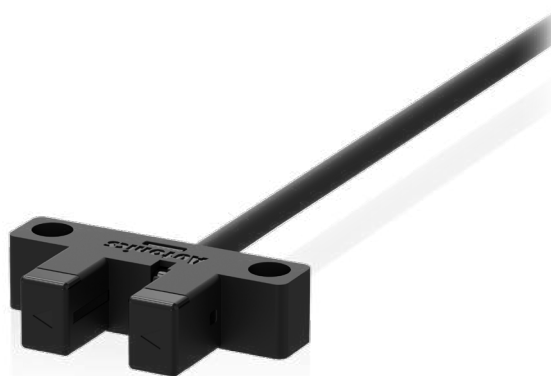

Features

- Ultra compact size
- Select appearance depending on the installation environment (K, F, R, U, L type)
- Minimize malfunction and improve visibility
 - Minimize sensing part, gap and flush of the body to reduce malfunctions caused by a foreign substance
 - Built-in the operation indicator can be checked in many directions
- Selectable models for the operation of indicator
 - Indicator turns ON under the light received condition
 - Indicator turns ON under the light interrupted condition
- Resistant structure for shock and vibration
 - Shock 15,000 m/s² (approx. 1,500 G)
 - Vibration 10 to 2,000 Hz (1.5 mm double amplitude)
- Selectable operation modes (Light ON / Dark ON)
- High-frequency response: 2 kHz

Specifications

Series	BS3
Sensing type	Through-beam
Sensing distance	5 mm
Sensing target	Opaque materials
Min. sensing target	≥ 0.8 mm × 1.8 mm
Hysteresis	≤ 0.05 mm
Response time	Received light: ≤ 20 μs, Interrupted light: ≤ 100 μs
Response frequency ⁰¹⁾	2 kHz
Light source	Infrared LED
Peak emission wavelength	940 nm
Operation mode	Built-in Light ON / Dark ON
Indicator	Operation indicator (red)
Approval	CE
Unit weight	≈ 50 g

01) Response frequency is the value getting from revolving the circle panel below.

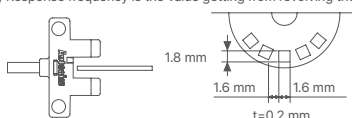

Power supply	5-24 VDC≐ ±10% (ripple P-P: ≤ 10%)
Current consumption	≤ 15 mA
Control output	NPN open collector output / PNP open collector output model
Load voltage	≤ 24 VDC≐
Load current	≤ 50 mA
Residual voltage	NPN: ≤ 1.2 VDC≐, PNP: ≤ 1.2 VDC≐
Protection circuit	Reverse power polarity protection circuit, output short overcurrent protection circuit
Insulation resistance	≥ 20 MΩ (250 VDC≐ megger)
Noise immunity	± 240 VDC≐ square wave noise (pulse width 1 μs) by the noise simulator
Dielectric strength	1,000 VAC~ 50/60 Hz for 1 min
Vibration	1.5 mm double amplitude (max. acceleration 196 m/s ²) at frequency of 10 to 2,000 Hz in each X, Y, Z direction for 2 hours
Shock	15,000 m/s ² (≈ 1,500 G) in each X, Y, Z direction for 3 times
Ambient illuminance (receiver)	Fluorescent lamp: ≤ 1,000 lx
Ambient temperature	-20 to 55 °C, storage: -25 to 85 °C (no freezing or condensation environment)
Ambient humidity	35 to 85%RH, storage: 35 to 85%RH (no freezing or condensation environment)
Protection rating	IP50 (IEC standard)
Connection method	Cable type
Cable spec.	∅ 2.5 mm, 4-wire, 1 m
Wire spec.	AWG28 (0.08 mm, 19-core), insulator outer diameter: ∅ 0.65 mm
Material	Case: PBT, sensing part: PC

Groove-Depth 6.5 mm

Photomicro Sensors

with Built-In Connector

BS4 Series



Features

- Minimize the external size with the assembled connector insertion part
 - Dedicated sold separately and universal connector cables available
 - Various shapes available for installation flexibility (K, L, R, T, TA, F, Y types)
- Minimize malfunction and improved visibility
 - Minimize sensing part and body level to reduce malfunctions caused by foreign substances
 - Built-in operation indicators viewable from multiple directions
- Selectable models for the operation of indicator
 - Indicator turns ON under the light received condition
 - Indicator turns ON under the light interrupted condition
- Resistant structure for shock and vibration
 - Shock 15,000 m/s² (≈ 1,500 G), vibration 10 to 2,000 Hz (1.5 mm double amplitude)
- Selectable operation modes (Light ON / Dark ON)
- High-frequency response: 2 kHz

Specifications

Series	BS4
Sensing type	Through-beam
Sensing distance	5 mm
Sensing target	Opaque materials
Min. sensing target	≥ 0.8 mm × 1.8 mm
Hysteresis	≤ 0.05 mm
Response time	Received light: ≤ 20 μs, Interrupted light: ≤ 80 μs
Response frequency	2 kHz ⁰¹⁾
Light source	Infrared LED
Peak emission wavelength	940 nm
Operation mode	Built-in Light ON / Dark ON
Indicator	Operation indicator (Red)
Approval	CE ENEC
Unit weight	≈ 2.4 g

01) Response frequency is the value getting from revolving the circle panel below.



Power supply	5-24 VDC≐ ±10% (ripple P-P: ≤ 10%)
Current consumption	≤ 15 mA
Control output	NPN open collector output / PNP open collector output Model
Load voltage	≤ 24 VDC≐
Load current	≤ 50 mA
Residual voltage	NPN: ≤ 1.2 VDC≐, PNP: ≤ 1.2 VDC≐
Protection circuit	Reverse power polarity protection circuit, output short overcurrent protection circuit
Insulation resistance	≥ 20 MΩ (250 VDC≐ megger)
Noise immunity	± 240 VDC≐ square wave noise (pulse width 1 μs) by the noise simulator
Dielectric strength	1,000 VAC~ 50/60 Hz for 1 min
Vibration	1.5 mm double amplitude (max. acceleration 196 m/s ²) at frequency of 10 to 2,000 Hz in each X, Y, Z direction for 2 hours
Shock	15,000 m/s ² (≈ 1,500 G) in each X, Y, Z direction for 3 times
Ambient illuminance (receiver)	Fluorescent lamp: ≤ 1,000 lx
Ambient temperature	-20 to 55°C, Storage: -25 to 85°C (no freezing or condensation environment)
Ambient humidity	35 to 85%RH, Storage: 35 to 85%RH (no freezing or condensation environment)
Protection rating	IP50 (IEC standard)
Connection method	Connector type
Material	Case: PBT, sensing part: PC

Groove-Depth 9 mm

Photomicro Sensors

BS5 Series



Features

- Select appearance depending on the install location (K, T, V, L, Y, F, R, TA type)
- Minimize malfunction and improve visibility
 - Minimize sensing part, gap and flush of the body to reduce malfunctions caused by a foreign substance
 - Built-in U-shaped indicator can be checked in many directions
- Selectable models for the operation of indicator
 - Indicator turns ON under the light received condition
 - Indicator turns ON under the light interrupted condition
- Resistant structure for shock and vibration
 - Shock 15,000 m/s² (approx. 1,500 G), vibration 10 to 2,000 Hz (1.5 mm amplitude)
- Selectable operation modes (Light ON / Dark ON) via connector or control wire
- High-frequency response: 2 kHz

Specifications

Series	BS5
Sensing type	Through-beam
Sensing distance	5 mm
Sensing target	Opaque materials
Min. sensing target	≥ 0.8 mm × 2 mm
Hysteresis	≤ 0.05 mm
Response time	Received light: ≤ 20 μs, Interrupted light: ≤ 100 μs
Frequency response	2 kHz ⁰¹⁾
Light source	Infrared LED
Peak emission wavelength	940 nm
Operation mode	Light ON-Dark ON selectable (control wire)
Indicator	Operation indicator (red)
Approval	CE
Unit weight	Cable type: ≈ 50 g, Connector type: ≈ 30 g

01) Response frequency is the value getting from revolving the circle panel below.

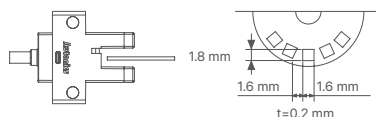

Power supply	5-24 VDC≐ ±10 % (ripple P-P: ≤ 10 %)
Current consumption	≤ 30 mA
Control output	NPN open collector / PNP open collector output model
Load voltage	≤ 30 VDC≐
Load current	≤ 100 mA
Residual voltage	NPN: ≤ 1.2 VDC≐, PNP: ≤ 1.2 VDC≐
Protection circuit	Reverse power polarity protection circuit, output short overcurrent protection circuit
Insulation resistance	≥ 20 MΩ (250 VDC≐ megger)
Noise immunity	The square wave noise (pulse width: 1μs) by the noise simulator ± 240 VDC≐
Dielectric strength	1,000 VAC~ 50/60 Hz for 1 minute
Vibration	1.5 mm double amplitude (max. acceleration 196 m/s ²) at frequency of 10 to 2,000 Hz in each X, Y, Z direction for 2 hours
Shock	15,000 m/s ² (approx. 1,500 G) in each X, Y, Z direction for 3 times
Ambient illumination (receiver)	Fluorescent lamp: ≤ 1,000
Ambient temperature	-20 to 55 °C, storage: -25 to 85 °C (no freezing or condensation)
Ambient humidity	35 to 85%RH, storage: 35 to 85%RH (no freezing or condensation)
Protection rating	IP50 (IEC standard)
Connection method	Cable / Connector type model
Cable spec.	Ø 3 mm, 4-wire, 1 m
Wire spec.	AWG28 (0.08 mm, 19-core), insulator outer diameter: Ø 0.88 mm
Material	Case: PBT, Sensing part: PC

Push-Button Type Photomicro Sensors

BS5-P Series



Features

- Button operation enables accurate detection regardless of material, color, or reflectance of target object
- Optimized for transport detection of semiconductor wafer enclosures (FOUP, FOSB, etc.)
- Optical detection of button operation guarantees 5 million operations of the mechanical life cycle
- Total of 4 red LED indicators (side: 2, top: 2) for higher visibility of operation status
- Increased product durability with steel mounting brackets
- Emitter OFF function and check stable operation functions
- Built-in reverse polarity protection circuit and output short overcurrent protection circuit

Specifications

Model	BS5-P1M□-□	BS5-P1M□-□-U
Sensing type	Push button type	
Button stop position ⁰¹⁾	5.0 ± 0.4 mm	
Button output switching position ⁰¹⁾	4.0 ± 0.5 mm	
Button operation limit position ⁰¹⁾	≤ 0 mm	
Operation load ⁰¹⁾	≤ 3 N	
Light source	Infrared LED	
Peak emission wavelength	940 nm	
Emitter OFF	YES (External input ⁰²⁾)	
Check stable operation	YES (External input ⁰²⁾)	
Operation mode	Light ON (Unpressed button, indicator + output ON) / Dark ON (Pressed button, indicator + output ON) mode model	
Indicator	Operation indicator (red)	
Approval	CE EAC	CE 
Unit weight (packaged)	≈ 30 g (≈ 50 g)	≈ 30 g (≈ 50 g)

01)

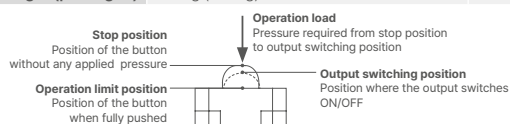

02)

External input	NPN output	PNP output
Emitter OFF	Short at 0 V or ≤ 0.25 VDC (outflow current ≤ 30 mA)	Short at +V or +V ≥ -0.25 VDC (absorption current ≤ 30 mA)
Emitter ON	Open (leakage current ≤ 0.4 mA)	Open (leakage current ≤ 0.4 mA)
Response time	≤ 1 ms	
Power supply	12-24 VDC ± 10% (ripple P-P: ≤ 10%)	
Current consumption	≤ 35 mA	
Control output	NPN open collector output / PNP open collector output model	
Load voltage	≤ 26.4 VDC	
Load current	≤ 50 mA	
Residual voltage	NPN: ≤ 1.5 VDC, PNP: ≤ 1.5 VDC	
Protection circuit	Reverse power protection circuit, output short overcurrent protection circuit	
Insulation resistance	≥ 20 MΩ (250 VDC megger)	
Noise immunity	±240 VDC the square wave noise (pulse width: 1 μs) by the noise simulator	
Dielectric strength	1,000 VAC ~ at 50/60 Hz for 1 min	
Vibration	1.5 mm double amplitude at 10 to 55 Hz frequency in each X, Y, Z direction for 2 hours	
Shock	500 m/s ² (≈ 50 G) in each X, Y, Z direction for 3 times	
Mechanical life cycle	≥ 5,000,000 operations (1 operation = stop position - operation limit position - stop position)	
Ambient illumination (receiver)	Fluorescent lamp: ≤ 1,000 lx	
Ambient temperature	-20 to 55 °C, storage: -25 to 70 °C (no freezing or condensation)	
Ambient humidity	35 to 85 %RH, storage: 35 to 85 %RH (no freezing or condensation)	
Protection rating	IP40 (IEC standard)	
Connection method	Cable type	
Cable spec.	Ø 3 mm, 4-wire, 1 m	
Wire spec.	AWG28 (0.08 mm, 19-core), insulator outer diameter: Ø 0.88 mm	
BS5-P1M□-□-□	AWG26 (0.08 mm, 30-core), insulator outer diameter: Ø 0.93 mm	
BS5-P1M□-□-U	AWG26 (0.08 mm, 28-core), insulator outer diameter: Ø 0.9 mm	
Material	Case: PC + G, button: POM, sleeve: SUS304	
BS5-P1M□-□-□	Case: PC + G, button: POM, sleeve: SUS304	
BS5-P1M□-□-U	Case: PC, button: POM, sleeve: SUS304	



A3. Fiber Optic Sensors

Fiber optic sensors combine optic fiber cables and amplifiers to provide accurate detection of objects in various applications.

A3-1	Fiber Optic Amplifiers	BF5 Series	Single / Dual Display Fiber Optic Amplifiers
		BF4 Series	Button Adjustment Fiber Optic Amplifiers
		BF3 Series	Volume Adjustment Fiber Optic Amplifiers
		BFX Series	Dual Display Fiber Optic Amplifiers
		BFC Series	Fiber Optic Amplifier Communication Converters
A3-2	Fiber Optic Units	FT / GT Series	Through-Beam Type Fiber Optic Units
		FD / GD Series	Retroreflective Type Fiber Optic Units
		FL / GL Series	Convergent Reflective Type Fiber Optic Units

Single / Dual Display Fiber Optic Amplifiers

BF5 Series



Features

- Dual-display for light incident level and setting value (BF5 -D)
- Enables to detect the minute object with 1 / 10,000 high resolution
- Enables to detect with high-speed moving object (response time 50 μ s)
- 5 response times:
ultra fast mode (50 μ s), fast mode (150 μ s), standard mode (500 μ s), long distance mode (4 ms), ultra long distance mode (10 ms)
- Anti-saturation setting function prevents malfunction by saturated light
- Easy sensitivity setting
- Long lasting amplifier regardless of element's life degradation or temperature change
- Multiple sensitivity setting modes available: auto-tuning, 1-point (maximum sensitivity), 2-point, positioning teaching
- Up to 8 units enable to connect with mutual interference prevention function using side connectors
- Auto channel setting function for multiple installations
- Adopts red, green, blue light sources
- Slim design with depth 10 mm (W 10 × H 30 × L 70 mm)

Specifications

Model	BF5R-D1-□	BF5G-D1-□	BF5B-D1-□
Light source	Red LED	Green LED	Blue LED
Peak emission wavelength	660 nm, modulated	530 nm, modulated	470 nm, modulated
Response time	Standard (500 μ s), Long distance (4 ms), Ultra long distance (10 ms), Ultra fast (50 μ s), Fast (150 μ s) mode		
Sensitivity setting	Manual, Teaching (Auto-tuning, 1-point, 2-point, positioning)		
Operation mode	Light ON, Dark ON		
Measured value display	7-segment LCD, 4-digit (decimal, percentage)		
Operation mode of the timer	OFF, OFF Delay, ON Delay, One-shot		
Max. cascading units	≤ 31 units		
Mutual interference prevention	≤ 8 units		
Indicator	Operation indicator (red), display screen (PV display part: red LED, SV display part: green LED)		
Approval	CE EAC	CE EAC	CE EAC
Unit weight (packaged)	≈ 20 g (≈ 138 g)	≈ 20 g (≈ 138 g)	≈ 20 g (≈ 138 g)
Model	BF5R-S1-□		
Light source	Red LED		
Peak emission wavelength	660 nm, modulated		
Response time	Standard (500 μ s), Long distance (4 ms), Fast (150 μ s) mode		
Sensitivity setting	Manual, Teaching (Auto-tuning)		
Operation mode	Light ON, Dark ON		
Measured value display	7-segment LCD, 4-digit (decimal, percentage)		
Operation mode of the timer	OFF Delay (time range: OFF, 10 ms, 40 ms)		
Mutual interference prevention	≤ 8 units		
Indicator	Operation indicator (red), display screen (PV / SV display part: red LED)		
Approval	CE EAC		
Unit weight (packaged)	≈ 20 g (≈ 138 g)		

Power supply	12-24 VDC \pm 10% (ripple P-P: \leq 10%)
Current consumption	\leq 50 mA
Control output	NPN open collector output / PNP open collector output model
Load voltage	\leq 24 VDC \pm
Load current	\leq 100 mA
Residual voltage	NPN: \leq 1 VDC \pm , PNP: \leq 3 VDC \pm
Protection circuit	Reverse power protection circuit, output short over current protection circuit, surge protection circuit
Insulation resistance	\geq 20 M Ω (500 VDC \pm megger)
Dielectric strength	1,000 VAC \sim 50 / 60 Hz for 1 min
Vibration	1 mm double amplitude at frequency 10 to 55 Hz (for 1 min) in each X, Y, Z direction for 2 hours
Shock	500 m/s ² (\approx 50 G) in each X, Y, Z direction for 3 times
Ambient illuminance (receiver)	Sunlight: \leq 11,000 lx, incandescent lamp: \leq 3,000 lx
Ambient temperature	-10 to 50 °C, storage: -20 to 70 °C (no freezing or condensation)
Ambient humidity	35 to 85%RH, storage: 35 to 85%RH (no freezing or condensation)
Protection rating	IP40 (IEC standard)
Connection	Connector cable
Cable spec.	\varnothing 4 mm, 3-wire, 2 m
Wire spec.	AWG22 (0.08 mm, 60-core), insulator outer diameter: \varnothing 1.25 mm
Tightening torque for fiber optic unit	\geq 2kgf
Material	Case: PBT, cover: PC

Button Adjustment

Fiber Optic Amplifiers

BF4 Series



Features

- High response time: max. 0.5 ms
- Auto sensitivity setting (button setting) / remote sensitivity setting type
- External synchronization input, mutual interference protection, self-diagnosis
- Reverse power protection and output short overcurrent protection circuit
- Timer function: OFF delay timer approx. 40 ms fixed.
(standard type, remote sensitivity setting type only)
- Automatically selectable Light ON / Dark ON
- Precise detection of small target and easy to install in the complicated place

Specifications

Model	BF4R□□-□	BF4G□□-□
Light source	Red LED	Green LED
Peak emission wavelength	660 nm, modulated	525 nm, modulated
Response time	Built-in 2 differential frequencies (frequency 1: ≤ 0.5 ms, frequency 2: ≤ 0.7 ms)	
Sensitivity setting	Button / Remote sensitivity setting	
Operation mode	Light ON / Dark ON selectable	
Self-diagnosis output	YES	
Load voltage	≤ 30 VDC \equiv	
Load current	≤ 50 mA	
Residual voltage	NPN: ≤ 1 VDC \equiv (load current: 50 mA), ≤ 0.4 VDC \equiv (load current: 16 mA) PNP: ≤ 2.5 VDC \equiv	
Indicator	Operation indicator (red), stability indicator (green)	
Approval	CE ENEC	CE ENEC
Unit weight (packaged)	≈ 65 g (≈ 120 g)	≈ 65 g (≈ 120 g)
Power supply	12-24 VDC \equiv $\pm 10\%$ (ripple P-P: $\leq 10\%$)	
Current consumption	≤ 45 mA	
Control output	NPN open collector output / PNP open collector output model	
Load voltage	≤ 30 VDC \equiv	
Load current	≤ 100 mA	
Residual voltage	NPN: ≤ 1 VDC \equiv (load current: 100 mA), ≤ 0.4 VDC \equiv (load current: 16 mA) PNP: ≤ 2.5 VDC \equiv	
Protection circuit	Reverse power protection circuit, output short overcurrent protection circuit	
Insulation resistance	≥ 20 M Ω (500 VDC \equiv megger)	
Noise immunity	± 240 VDC \equiv the square wave noise (pulse width: 1 μ s) by the noise simulator	
Dielectric strength	1,000 VAC \sim 50 / 60 Hz for 1 min	
Vibration	1 mm double amplitude at frequency 10 to 55 Hz (for 1 min) in each X, Y, Z direction for 2 hours	
Shock	500 m/s 2 (≈ 50 G) in each X, Y, Z directions for 3 times	
Ambient illuminance (receiver)	Sunlight: $\leq 11,000$ lx, incandescent lamp: $\leq 3,000$ lx	
Ambient temperature	-10 to 50 $^{\circ}$ C, storage: -20 to 70 $^{\circ}$ C (no freezing or condensation)	
Ambient humidity	35 to 85%RH, storage: 35 to 85%RH (no freezing or condensation)	
Cable spec.	Standard type: $\varnothing 4$ mm, 4-wire, 2 m External synchronization input, remote sensitivity setting type: $\varnothing 4$ mm, 6-wire, 2 m	
Wire spec.	Standard type: AWG22 (0.08 mm, 60-core), insulator outer diameter: $\varnothing 1.25$ mm External synchronization input, remote sensitivity setting type: AWG24 (0.08 mm, 40-core), insulator outer diameter: $\varnothing 1$ mm	
Material	Case: heat-resistance ABS, cover: PC	

Volume Adjustment

Fiber Optic Amplifiers

BF3 Series



Features

- Convenient DIN rail mounting type
- Response time: max. 1 ms
- Enables to adjust sensitivity with high accuracy by coarse and fine adjuster
- Selectable Light ON / Dark ON operation mode by control wire
- Reverse power protection and output short overcurrent protection circuit
- Adjustable length with free cut type fiber optic unit

Specifications

Model	BF3RX-□
Light source	Red LED
Peak emission wavelength	660 nm, modulated
Response time	≤ 1 ms
Sensitivity setting	Manual sensitivity setting (adjuster)
Operation mode	Light ON / Dark ON selectable (control wire)
Indicator	Operation indicator (red)
Approval	ENE
Unit weight	≈ 90 g
Power supply	12-24 VDC≐ ±10% (ripple P-P: ≤ 10%)
Current consumption	≤ 40 mA
Control output	NPN open collector output / PNP open collector output model
Load voltage	≤ 30 VDC≐
Load current	≤ 200 mA
Residual voltage	NPN: ≤ 1 VDC≐, PNP: ≤ 2.5 VDC≐
Protection circuit	Reverse power protection circuit, output short overcurrent protection circuit
Insulation resistance	≥ 20 MΩ (500 VDC≐ megger)
Noise immunity	±240 VDC≐ the square wave noise (pulse width: 1 μs) by the noise simulator
Dielectric strength	1,000 VAC~ 50 / 60 Hz for 1 min
Vibration	1 mm double amplitude at frequency of 10 to 55 Hz (for 1 min) in each X, Y, Z direction for 2 hours
Shock	500 m/s ² (≈ 50 G) in each X, Y, Z direction for 3 times
Ambient illuminance (receiver)	Sunlight: ≤ 11,000 lx, incandescent lamp: ≤ 3,000 lx
Ambient temperature	-10 to 50 °C, storage: -25 to 70 °C (no freezing or condensation)
Ambient humidity	35 to 85%RH, storage: 35 to 85%RH (no freezing or condensation)
Cable spec.	Ø 5 mm, 4-wire, 2 m
Wire spec.	AWG24 (0.08 mm, 40-core), insulator outer diameter: Ø 1 mm
Material	Case: ABS, cover: PC

Dual Display

Fiber Optic Amplifiers

BFX Series



Features

- Dual-display for light incident level and setting value
- Enables to detect the minute object with 1/10,000 high resolution
- Enables to detect with high-speed moving object (response time 50 μ s)
- 5 response times: ultra fast mode (50 μ s), fast mode (150 μ s), standard mode (500 μ s), long distance mode (4 ms), ultra long distance mode (10 ms)
- Anti-saturation setting function prevents malfunction by saturated light
- External input: emitter OFF, remote sensitivity setting, peak reset, output ON/OFF/Keep, energy saving OFF
- Multiple sensitivity setting modes available: auto tuning (fine-adjusting sensitivity) teaching sensitivity setting (button or external input auto-tuning, 1-point, 2-point, positioning)

Specifications

Model	BFX-D1-□
Light source	Red LED
Peak emission wavelength	660 nm, modulated
Response time	Standard (500 μ s), Long distance (4 ms), Ultra long distance (10 ms), Ultra fast (50 μ s), Fast (150 μ s) mode
Sensitivity setting	Manual, Teaching (Auto-tuning, 1-point, 2-point, positioning)
Operation mode	Light ON, Dark ON
Measured value display	7-segment LCD, 4-digit (decimal, percentage)
Operation mode of the timer	OFF, OFF Delay, ON Delay, One-shot
External input	Teaching sensitivity, initialization of the incident light level, emitter OFF, control output setting, energy saving mode release
Indicator	Operation indicator (red), display screen (PV display part: red LED, SV display part: green LED)
Approval	CE ENEC
Unit weight (packaged)	\approx 16 g (\approx 115 g)
Power supply	12-24 VDC \pm 10% (ripple P-P: \leq 10%)
Current consumption	\leq 50 mA
Control output	NPN open collector output / PNP open collector output model
Load voltage	\leq 24 VDC \pm
Load current	\leq 100 mA
Residual voltage	NPN: \leq 1 VDC \pm , PNP: \leq 3 VDC \pm
Protection circuit	Reverse power protection circuit, output short overcurrent protection circuit, surge protection circuit
Insulation resistance	\geq 20 M Ω (500 VDC \pm megger)
Dielectric strength	1,000 VAC \sim 50 / 60 Hz for 1 min
Vibration	1 mm double amplitude at frequency 10 to 55 Hz (for 1 min) in each X, Y, Z direction for 2 hours
Shock	500 m/s ² (\approx 50 G) in each X, Y, Z direction for 3 times
Ambient illuminance (receiver)	Sunlight: \leq 11,000 lx, incandescent lamp: \leq 3,000 lx
Ambient temperature ⁰¹⁾	-10 to 50 °C, storage: -20 to 70 °C (no freezing or condensation)
Ambient humidity	35 to 85%RH, storage: 35 to 85%RH (no freezing or condensation)
Protection rating	IP40 (IEC standard)
Connection	Connector cable
Cable spec.	\varnothing 4 mm, 4-wire, 2 m
Wire spec.	AWG22 (0.08 mm, 60-core), insulator outer diameter: \varnothing 1.25 mm
Tightening torque for fiber optic unit	\geq 2kgf
Material	Case: POK, cover: PC

01) 1 to 2 units: -10 to 50 °C, 3 to 8 units: -10 to 35 °C
 Be cautious about the heat transfer when the number of connected units is more than 8.
 The ambient temperature varies with the number of connected amplifiers that are mounted on the DIN rail.
 Be sure to check the temperatures when installing in the enclosed area.

Fiber Optic Amplifier Communication Converters

BFC Series



Features

- Sets all Functional performance and parameters from external devices (PC, PLC)
- Supports various communications: RS485 communication, Serial Communication, SW input
- Connected up to 32 amplifiers (BF5 series)
- Slim design with depth 10 mm (W 10 × H 30 × L 70 mm)

Specifications

Model	BFC-□
Supported amplifier	BF5 Series
Comm. function	RS485, Serial communication, Switch (SW) input
Switch (SW) input	HIGH: 5-24 VDC≐, LOW: 0-1 VDC≐
Function	Real-time monitoring (incident light level, output state), Executes all functions and sets the parameters of BF5 Series via external devices (PC, PLC)
Indicator	TX indicator (red), RX indicator (green), display screen (PV display part: red LED, SV display part: green LED)
Approval	CE ENEC
Unit weight	≈ 15 g
Power supply	12-24 VDC≐ ±10% (using the power supply of the connected amplifier)
Current consumption	≤ 40 mA
Control output	NPN solid-state input / PNP solid-state input model
Vibration	1 mm double amplitude at frequency 10 to 55 Hz (for 1 min) in each X, Y, Z direction for 2 hours
Shock	500 m/s ² (≈ 50 G) in each X, Y, Z direction for 3 times
Ambient temperature	-10 to 50 °C, storage: -20 to 60 °C (no freezing or condensation)
Ambient humidity	35 to 85%RH, storage: 35 to 85%RH (no freezing or condensation)
Protection rating	IP40 (IEC standard)
Connection	Connector cable
Cable spec.	Ø 4 mm, 4-wire, 2 m
Wire spec.	AWG22 (0.08 mm, 60-core), insulator outer diameter: Ø 1.25 mm
Material	Case: PBT, cover: PC
Comm. protocol	Modbus RTU

Through-Beam Type Fiber Optic Units





FT / GT Series























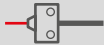

Features

- Various head types and sensing methods for diverse environments
- Thread, cylindrical, flat, L-shaped, plastic, perpendicular, stainless steel, U-shaped and area detection head types for various user requirements
- Through-beam, retroreflective and convergent reflective methods are available for diverse working conditions

* Icon Overview

-  **Std.**
Standard:
Fiber optic units for general purpose
-  **Heat-resistant:**
Fiber optic units for the high-temperature environment (-60 to 350°C)
-  **Vacuum-resistant:**
Fiber optic units for the high-temperature (-60 to 250°C) and vacuum environment
-  **Flexible (R1, R2):**
Fiber optic units for withstanding repeated flexing
-  **Bending-resistant (R5):**
Fiber optic units for withstanding repeated bending

Line Up

	Standard	Heat-resistant	Vacuum-resistant	Bending-resistant	Flexible
Threaded head 	Std.				
Cylindrical head 	Std.				
Flat head 					
L-shaped head 	Std.				
Molded plastic head 	Std.				
Perpendicular head 					
SUS head 	Std.				
U-shaped head 					
Wide area head 					

Retroreflective Type Fiber Optic Units

FD / GD Series



Sensors

Features

- Various head types and sensing methods for diverse environments
- Thread, cylindrical, flat, L-shaped, plastic, perpendicular, stainless steel, U-shaped and area detection head types for various user requirements
- Through-beam, retroreflective and convergent reflective methods are available for diverse working conditions

* Icon Overview



Standard:
Fiber optic units for general purpose



Heat-resistant:
Fiber optic units for the high-temperature environment (-60 to 350°C)



Vacuum-resistant:
Fiber optic units for the high-temperature (-60 to 250°C) and vacuum environment























Flexible (R1, R2):
Fiber optic units for withstanding repeated flexing



Bending-resistant (R5):
Fiber optic units for withstanding repeated bending

Line Up

	Standard	Heat-resistant	Vacuum-resistant	Bending-resistant	Flexible
Threaded head 	Std.				
Cylindrical head 	Std.				
Flat head 					
L-shaped head 					
Molded plastic head 	Std.				
Perpendicular head 					
SUS head 	Std.				
Wide area head 					

A

Convergent Reflective Type Fiber Optic Units





FL / GL Series



Features

- Various head types and sensing methods for diverse environments
- Thread, cylindrical, flat, L-shaped, plastic, perpendicular, stainless steel, U-shaped and area detection head types for various user requirements
- Through-beam, retroreflective and convergent reflective methods are available for diverse working conditions

Line Up

	Standard	Heat-resistant	Vacuum-resistant	Flexible
Flat head (flat view) 	Std.			
Flat head (top view) 	Std.			

* Icon Overview



Standard:
Fiber optic units for general purpose



Heat-resistant:
Fiber optic units for the high-temperature environment (-60 to 350°C)



Vacuum-resistant:
Fiber optic units for the high-temperature (-60 to 250°C) and vacuum environment



Flexible (R1, R2):
Fiber optic units for withstanding repeated flexing



A4. Displacement Sensors

Displacement sensors can measure thickness, width, level difference, disparity, curve, evenness of target objects by detecting the amount of displacement using laser beams.

A4-1	Displacement Sensors	BD Series	Laser Displacement Sensors (Sensor Head and Amplifier Unit)
		BD-C Series	Laser Displacement Sensor Communication Converter

Laser Displacement Sensor (Sensor Head)

BD Series





Features

- Easy maintenance with detachable sensor head / amplifier unit
- Maximum resolution: 1 μm (vary by model)
- Accurate measurement with minimal influence from target color or material
- Interconnection of up to 8 sensor Amplifier units:
Mutual interference prevention function and auto channel sorting
- Various calculation functions supported (addition, subtraction, average)
- Various filter functions for stable measurement (movement average, differential, median)
- Auto sensitivity adjustment (1-point, 2-point teaching)
- DIN rail and wall mount support (bracket accessory required for wall mount)
- Sensor head: IP67 protection structure
- Extension cables available for various moving applications (sold separately)

Specifications

[Sensor head]

Model	BD-030	BD-065	BD-100
Beam shape	Standard		
Spot diameter (near)	$\approx 290 \times 790 \mu\text{m}$ (25 mm)	$\approx 360 \times 1,590 \mu\text{m}$ (55 mm)	$\approx 480 \times 1,870 \mu\text{m}$ (80 mm)
Spot diameter (reference)	$\approx 240 \times 660 \mu\text{m}$ (30 mm)	$\approx 290 \times 1,180 \mu\text{m}$ (65 mm)	$\approx 410 \times 1,330 \mu\text{m}$ (100 mm)
Spot diameter (far)	$\approx 190 \times 450 \mu\text{m}$ (35 mm)	$\approx 210 \times 830 \mu\text{m}$ (75 mm)	$\approx 330 \times 950 \mu\text{m}$ (120 mm)
Resolution ⁰¹⁾	1 μm	2 μm	4 μm
Reference distance	30 mm	65 mm	100 mm
Maximum measurement range	20 to 40 mm	50 to 80 mm	70 to 130 mm
Rated measurement ranges ⁰²⁾	25 to 35 mm	55 to 75 mm	80 to 120 mm
Linearity ^{01) 03)}	$\pm 0.1\%$ of F.S.	$\pm 0.1\%$ of F.S.	$\pm 0.15\%$ of F.S.
Temperature characteristic ⁰⁴⁾	0.05% F.S./ $^{\circ}\text{C}$	0.06% F.S./ $^{\circ}\text{C}$	
Power supply ⁰⁵⁾	-		
Light source	Red semiconductor laser (wavelength: 660 nm, IEC 60825-1:2014)		
Optical method	Diffuse reflection		
Laser class	Class 1 (IEC/EN), Class I (FDA (CDRH) CFR Part 1002)	Class 2 (IEC/EN), Class II (FDA (CDRH) CFR Part 1002)	
Output	$\leq 300 \mu\text{W}$	$\leq 1 \text{ mW}$	
Operation Indicator	Power Indicator (red), Laser emission indicator (green), NEAR/FAR indicator (green)		
Connection	Connector type		
Insulation resistance	$\geq 20 \text{ M}\Omega$ (500 VDC== megger)		
Noise immunity	Square shaped noise by noise simulator (pulse width: 1 μs) $\pm 500\text{V}$		
Dielectric strength	1,000 VAC~ 50/60 Hz for 1 minute		
Vibration	1.5 mm amplitude at frequency of 10 to 55Hz (for 1 min) in each X, Y, Z direction for 2 hours		
Shock	300 m/s ² ($\approx 30 \text{ G}$) in each X, Y, Z direction for 3 times		
Ambient illumination	$\leq 10,000 \text{ lx}$ Incandescent lamp		
Ambient temperature	-10 to 50 $^{\circ}\text{C}$, Storage: -15 to 60 $^{\circ}\text{C}$ (no freezing or condensation)		
Ambient humidity	$\leq 85\% \text{RH}$, Storage: $\leq 85\% \text{RH}$ (no freezing or condensation)		
Protection structure	IP67 (IEC Standards, except connector of extension cable)		
Material	Case: Polycarbonate, Sensing part: Glass, Cable: Polyvinyl chloride		
Amplifier unit compatibility	BD Series amplifier unit: 1		
Accessory	Ferrite core (made by TDK co. ZCAT2132-1130), Mounting bracket, Bolt, Nut		
Approval	CE  		
Unit weight (packaged)	$\approx 56 \text{ g}$ ($\approx 209 \text{ g}$)	$\approx 68 \text{ g}$ ($\approx 233 \text{ g}$)	$\approx 68 \text{ g}$ ($\approx 233 \text{ g}$)

01) When measuring fixed non-glossy white paper (reference temperature: 25 $^{\circ}\text{C}$, reference distance, response time: 1 ms, average 128 times).

02) The rated measurement range guarantees linearity.

03) Value indicates the error with respect to the ideal straight line.

04) Value measured by using an aluminum jig fix the sensor head and non-glossy white paper.

05) Using power from the amplifier unit.

Laser Displacement Sensors (Amplifier Unit)

BD-A1



Specifications

[Amplifier unit]

Model	BD-A1
Power supply	10 - 30 VDC \pm 10% (when connecting BD-C Series communication converter, 12-30 VDC \pm)
Power consumption ⁰¹⁾	\leq 2,800 mW (30 VDC \pm)
Control Input ⁰²⁾	Timing / Output reset / Laser OFF / Zero-point adjustment / Bank change: No-voltage input
Judgment output (HIGH/GO/LOW)	NPN or PNP open collector output (load current: \leq 100 mA)
Alarm output	NPN or PNP open collector output (load current: \leq 100 mA)
Analog voltage output ⁰³⁾	-5 - 5 V, 0 - 5 V, 1 - 5 V (resistance: 100 Ω , \pm 0.05% F.S., at 10 V)
Analog current output ⁰³⁾	4 - 20 mA (load resistance: \leq 350 Ω , \pm 0.2% F.S., at 16 mA)
Residual voltage	NPN: \leq 1.5 V, PNP: \leq 2.5 V
Protection circuit	Reverse polarity protection circuit, output over current (short-circuit) protection circuit
Response Time	0.33 / 0.5 / 1 / 2 / 5 ms
Min. display unit	1 μ m
Display type	11 segment (red, green), 6-digit, LED
Display range ⁰⁴⁾	\pm 99.999 mm to \pm 99 mm (4-step adjustment, parameter)
Display period	\approx 100 ms
Insulation resistance	\geq 20 M Ω (500 VDC \pm megger)
Noise immunity	Square shaped noise by noise simulator (pulse width: 1 μ s) \pm 500 V
Dielectric strength	1,000 VAC \sim 50/60 Hz for 1 minute
Vibration	1.5 mm amplitude at frequency of 10 to 55 Hz (for 1 min) in each X, Y, Z direction for 2 hours
Shock	300 m/s ² (approx. 30 G) in each X, Y, Z direction for 3 times
Ambient temperature	-10 to 50 °C, Storage: -15 to 60 °C (no freezing or condensation)
Ambient humidity	\leq 85%RH, Storage: \leq 85%RH (no freezing or condensation)
Material	Case: PC, Cover: PC, cable: PVC
Connection	Connector type
Sensor head compatibility	BD series sensor head: 1
Accessory	Mounting bracket, Side connector
Protection structure	IP40 (IEC standard)
Approval	CE RoHS ENEC
Unit weight (packaged)	\approx 126 g (\approx 228 g)

01) Power to the load is not included.

02) Use after assigning to external input line.

03) It is possible to use among -5-5V, 0-5V, 1-5V, 4-20mA by parameter setting.

04) Setting range is assigned automatically when connecting sensor head.

Laser Displacement Sensor Communication Converter

BD-C Series



Features

- Supports both RS232C and RS485 communication in one device:
Separate ports for RS232C and RS485
- Connect up to 8 amplifier units
- Can be powered directly by amplifier units without additional wiring
- Support for dedicated device management software (atDisplacement)
 - : Batch parameter settings with save / load function
 - : Monitor measured values and outputs in real-time
- Set communication speed and addresses using DIP switch without connecting to host devices

Specifications

Model	BD-CRS
Power supply ⁰¹⁾	-
Power Consumption	≤ 2.3 W
Communication Protocol	Modbus RTU
Connection type	RS-232C, RS-485
Communication speed	9600, 19200, 38400, 115200 bps (default)
Function	Executes every BD-Series feature, sets parameter and real-time monitoring by external device (Master)
Ambient temperature	-10 to 50 °C, Storage: -15 to 60 °C (no freezing or condensation)
Ambient humidity	≤ 85%RH, Storage: ≤ 85%RH (no freezing or condensation)
Vibration	1.5 mm amplitude at frequency of 10 to 55 Hz (for 1 min) in each X, Y, Z direction for 2 hours
Shock	300 m/s ² (≈ 50 G) in each X, Y, Z direction for 3 times
Protection structure	IP40 (IEC standard)
Material	Case: PC
Accessory	Side connector, Connector for RS485
Sold separately	Communication converter: SCM Series
Approval	CE c RoHS ENEC
Unit weight (packaged)	≈ 49 g (≈ 91 g)

01) Using power from the amplifier unit. To use BD-C Series communication converter, the amplifier unit needs 12-30 VDC power supply
* It is recommended to use Autonics communication converter. Please use twisted pair wire, which is suitable for RS485 communication.

Software

Download the installation file and the manuals from the Autonics website.

[atDisplacement]

atDisplacement is a PC software for BD series laser displacement sensors. It is available for parameter setting, monitoring and data management.

Visit our website (www.autonics.com) to download the user manual and the program.



A5. LiDAR

Laser scanners utilize time-of-flight (ToF) method to measure the round trip time of the infrared laser beam, to accurately detect presence of objects within a wide range area.

A5-1	2D Laser Scanners	LSC Series	2D 270° Laser Scanners
		LSE Series	2D 90° 4-Channel Laser Scanners
		LSE2 Series	2D 90° 1-Channel Laser Scanners

2D 270° Laser Scanners

LSC Series



Features

- Wide detection range up to 270°, 25 m
- Supports flexible field configuration with a total of 16 field sets (1 set: 3 fields)
- Accurate and stable object detection by supporting various filter functions
- Small size (L 60 × W 60 × H 86 mm) suitable for various installation environments
- Supports Ethernet communication
- Supports atLiDAR dedicated software
- ROS, API supported
- Sold separately
 - Ethernet cable (C18-2R-A, C18-5R-A, C18-10R-A, C48-2R-A, C48-5R-A, C48-10R-A)
 - Power I/O cable (CID-2-VG, CID-5-VG, CID-10-VG, CLD-2-VG, CLD-5-VG, CLD-10-VG)

Specifications

Model	LSC-C5CT3-ET	LSC-C10CT3-ET	LSC-C25CT3-ET
Environment of use	Indoor		
Emitting property	Infrared laser		
Laser class	CLASS 1		
Wave length band	905 nm		
Max. pulse output power	6 W		
Beam conversion angle	9.5 mrad		
Scanning frequency	15 Hz		
Response time	Typ. 67 ms		
Detection distance range	0.05 to 5 m	0.05 to 10 m	0.05 to 25 m
Max. detection distance of 10 % reflector	5 m	8 m	
Detection distance error	System error: Typ. ± 60 mm, statistical error: Typ. 20 mm (1 σ)		
Min. object size ⁰¹⁾	At detection distance of 8 m: ≈ 121 mm		
Angular resolution	0.33°		
Aperture angle	270°		
Object reflectivity	> 4 %		
Number of field sets	16 (1 set: Consists of subfields 1, 2, 3)		
Number of field sets that can be used concurrently	1		
Unit weight (package)	≈ 228 g (314 g)		
Approval	CE		
01) Even objects smaller than the set min. object size can be detected depending on the environment.			
Power supply	9 - 28 VDC==		
Power consumption ⁰¹⁾	< 4 W		
Input	4 Photocoupler inputs - H: ≥ 9 - 28 VDC==, L: ≤ 3 VDC==		
Output signal	NPN-PNP open collector output setting (software)		
Load voltage	9 - 28 VDC==		
Load current	≤ 100 mA		
Residual voltage	≤ 3.0 VDC==		
Insulation resistance	≥ 5 MΩ (500 VDC== megger)		
Dielectric strength	500 VAC~ 50 / 60 Hz for 1 minute		
Vibration	10 sweep cycles in each X, Y, Z axes at sine wave, 10 to 500 Hz, acceleration 5 G		
Vibration (malfunction)	10 minutes in each X, Y, Z axes at sine wave, 10 to 500 Hz, acceleration 5 G		
Vibration (irregular)	5 hours in each X, Y, Z axes at 5 to 250 Hz, 42.4 m/s ² RMS		
Shock	3 times in each X, Y, Z axes at sine half wave, acceleration 50 G, duration 11 ms 1000 times in each X, Y, Z axes at sine half wave, acceleration 25 G, duration 6 ms 5000 times in each X, Y, Z axes at sine half wave, acceleration 50 G, duration 3 ms		
Shock (malfunction)	6 times in each X, Y, Z axes at sine half wave, acceleration 50 G, duration 11 ms		
Ambient illuminance	≤ 80,000 lx		
Ambient temperature	-10 to 50 °C, storage: -30 to 70 °C (no freezing or condensation)		
Ambient humidity	0 to 95 %RH, storage: 0 to 95 %RH (no freezing or condensation)		
Protection structure	IP67 (IEC standard)		
Connector specification	Power I / O: M12 12-pin, Ethernet: M12 8-pin		
Material	Case: AL, Window: PC		
Comm. protocol	TCP/IP		

01) Excluding power supplied to the load

Software

Download the installation file and the manuals from the Autonics website. Supported devices are different for each software version.

[atLiDAR (V2.0 or later)]

atLiDAR is the management program for laser scanner parameter settings, status information and monitoring data, etc.

This program communicates with the laser scanner via Ethernet communication.

2D

90° 4-Channel Laser Scanners

LSE Series



Features

- Monitoring zone up to 90 °, 5.6 × 5.6 m
- Supports up to 4 channels
- Small size (W 125 × H 80.3 × L 88 mm) suitable for various installation environments
- Ethernet communication support
- atLiDAR, PC-only software support

Specifications

Model	LSE-4A5R2
Emitting property	Infrared laser
Laser class	CLASS 1
Wave length band	905 nm
Max. pulse output power	75 W
Response time	Typ. 20 to 80 ms + monitoring time
Scanning mode	Motion and presence
Monitoring zone	0.3 × 0.3 m to 5.6 × 5.6 m ⁰¹⁾
Front contamination	Normal operation with max. 30 % contamination of one material
Min. size of the scanning target ⁰²⁾	At detection distance of 3 m: ≈ W 2.1 × H 2.1 × L 2.1 cm At detection distance of 5 m: ≈ W 3.5 × H 3.5 × L 3.5 cm
Angular resolution	0.4°
Aperture angle	90°
Object reflectivity	≥ 2 %
Laser scanner angle	-45°, 0°, 45°
Bracket rotation angle ⁰³⁾	-5 to 5°
Bracket tilt angle	-3 to 3°
Life expectancy	≤ 6.8 years
Approval	CE
Korean Railway Standards	KRS SG 0068
Unit weight (package)	≈ 0.58 kg (≈ 0.96 kg)
<small>01) At object reflectivity: 10 % 02) At object reflectivity: 90 % (Kodak Gray card R-27, White) 03) Indicates the laser scanner adjustment range.</small>	
Power supply	24 VDC± ± 20 %
Power consumption	≤ 8 W
Communication interface	Ethernet (TCP/IP) 10BASE-T
Input	Photocoupler input H ⁰¹⁾ : ≥ 8 - 30 VDC±, L: ≤ 3 VDC±
Output	PhotoMOS relay output Galvanic isolation, non-polarity Resistive load: 30 VDC± / 24 VAC~, ≤ 80 mA Output resistance: 30 Ω Switching time: t _{ON} = 5 ms, t _{OFF} = 5 ms
Insulation resistance	≥ 5 MΩ (500 VDC± megger)
Dielectric strength	500 VAC~ 50 / 60 Hz for 1 minute
Vibration	≤ 2 G (18.7 m/s ²)
Shock	30 G / 18 ms
Ambient illuminance	Sunlight: ≤ 100,000 lx
Ambient temperature ⁰²⁾	-30 to 60 °C (no freezing or condensation)
Ambient humidity	0 to 95 %RH, storage: 0 to 95 %RH (no freezing or condensation)
Protection structure	IP67 (IEC standard)
Cable spec.	Power, I/O cable: Ø 5 mm, 8-wire, 5 m Ethernet cable: Ø 5 mm, 4-wire, 3 m, shield cable, RJ45 connector
Wire spec.	AWG26 (0.16 mm, 7-core), insulator outer diameter: Ø 1 mm
Material	PC

01) Operates as output test mode and outputs obstacle detection output and error status output.

02) Ambient temperature in power supplied status is -30 to 60°C and in power cut status is -10 to 60°C.

Software

Download the installation file and the manuals from the Autonics website.

[atLiDAR]

atLiDAR is the management program for laser scanner installation, parameter settings, status information and monitoring data, etc.
This program communicates with the laser scanner via Ethernet communication.

2D

90° 1-Channel Laser Scanners

LSE2 Series



Features

- 90° detection angle,
5.6 × 5.6 m detection range
- Compact size for flexible installation
(W 120 × H 47.5 × L 89.4 mm)
- Various filter function to prevent malfunction
due to fog, rain, snow and dusts
- Operation indicator to identify operation
status and errors:
check status even in unstable conditions or
change in installation location
- Ethernet communication supported
- Dedicated software atLiDAR provided:
PC, Mobile (Android)

Specifications

Model	LSE2-A5R2-ET
Laser for detection emitting property	Infrared laser: 1
Laser class	CLASS 1
Wave length band	905 nm
Max. pulse output power	27 W
Laser for installation emitting property	Visible light laser: 2
Laser class	CLASS 3R
Wave length band	650 nm
Max. CW ⁰¹⁾ output power	4 mW
Min. object size ⁰²⁾	OFF, 5, 8, 10, 15, 20, 25, 30, 35, 40 cm
Scanning frequency	25 Hz
Response time	≤ 50 ms + monitoring time
Monitoring zone ⁰³⁾	≤ 5.6 × 5.6 m
Angular resolution	0.25°
Aperture angle	90°
Object reflectivity ⁰⁴⁾	≥ 2 %
Approval	CE
Korean Railway Standards	KRS SG 0068
Unit weight (package)	≈ 0.8 kg (≈ 1 kg)

01) Continuous wave

02) It is based on a white reflector.

Even objects smaller than the set min. object size can be detected depending on the environment.

03) At detection distance: 4 m, object reflectivity: 5 %, fog filter level: 0

04) At detection distance: 1.5 m, fog filter level: 0, object size = W 700 × H 300 × L 200 mm

Power supply	24 VDC± ± 15 %
Power consumption	< 10 W
Input	Photocoupler input: 1 H ⁰¹⁾ : ≥ 8 - 30 VDC±, L: ≤ 3 VDC±
Output	PhotoMOS relay output: 2 Resistive load: 30 VDC± / 24 VAC~, ≤ 80 mA
Vibration	2 G
Shock	30 G / 18 ms
Ambient illuminance	Sunlight: ≤ 100,000 lx
Ambient temperature	-30 to 60 °C, storage: -30 ~ 70 °C (no freezing or condensation)
Ambient humidity	0 to 95 %RH, storage: 0 to 95 %RH (no freezing or condensation)
Protection structure	IP67 (IEC standard)
Cable spec.	Power I / O cable: Ø 5 mm, 8-wire, 5 m Ethernet cable: Ø 5 mm, 4-wire, 3 m, shield cable, RJ45 connector
Wire spec.	AWG26 (0.16 mm, 7-core), insulator outer diameter: Ø 1 mm
Material	Case: AL, Window: PC
Comm. protocol	TCP/IP

01) Operates as output test mode and outputs obstacle detection output and error status output.

Software

Download the installation file and the manuals from the Autonics website. Supported devices are different for each software version.

[atLiDAR (PC, V2.1 or later)]

atLiDAR is the management program for laser scanner parameter settings, status information and monitoring data, etc.

This program communicates with the laser scanner via Ethernet communication.

[atLiDAR (mobile)]

atLiDAR is Android only mobile application that can manage monitoring data such as laser scanner parameter settings and status information.

Connect the laser scanner with atLiDAR by connecting the USB-C to Ethernet gender.



A6. Door Sensors

Door sensors are special-purpose photoelectric sensors generally used in automatic door management systems.

A6-1	Door Sensors	ADS-A Series	Automatic Door Sensors
A6-2	Door Side Sensors	ADS-SE1/2 Series	Automatic Door Side Sensors

Automatic Door Sensors

ADS-A Series



Features

- Adjustable hold time switch (2, 7, 15 sec)
- 4-step detection angle adjustment (7.5°, 14.5°, 21.5°, 28.5°)
- Adjustable sensing area (left / right area elimination)
- Power supply:
24 - 240 VAC~ / 24 - 240 VDC==
(universal AC / DC type),
12 - 24 VAC~ / 12 - 24 VDC==
(universal AC / DC type)
- Built-in microprocessor
- Max. sensing area : 2460 × 86 mm
(installation height 2.7 m)

Specifications

Model	ADS-A0
Mounting height	2.0 to 2.7 m ⁰¹⁾
Sensing area	9-point
Sensing method	Infrared reflection method
Output holding time	Time delay ≈ 0.5 sec
Stationary sensing time	2 sec, 7 sec, 15 sec (holding time setting switch)
Interference prevention	H, L (interference prevention switch)
Adjust angle	7.5°, 14.5°, 21.5°, 28.5° (angle adjustment lever)
Eliminate right / left sensing area	(1, 2, 3 area), (7, 8, 9 area) (eliminating right / left sensing area lever)
Light source	Infrared chip diode (modulated)
Indicator	Operation indicator (orange, green, red)
Approval	ERC
Weight	≈ 320 g
01) In case of installing the unit higher than 2.7 m height, the unit may not detect small children. In case of installing the unit lower than 2.0 m height the unit may not work normally.	
Power supply	ADS-AF: 24 - 240 VAC~, 50 / 60 Hz, 24 - 240 VDC== (ripple P-P: ≤ 10 %) ADS-AE: 12 - 24 VAC~, 50 / 60 Hz, 12 - 24 VDC== (ripple P-P: ≤ 10 %)
Power consumption	ADS-AF: ≤ 4 VA (≤ 240 VAC~ at 50 / 60 Hz) ADS-AE: ≤ 2 VA (≤ 24 VAC~ at 50 / 60 Hz)
Control output	Relay contact output
Relay contact capacity ⁰¹⁾	50 VDC== 0.1 A (resistive load)
Relay contact composition	1a
Relay life cycle	Mechanical: ≥ 20,000,000 times, electrical: ≥ 50,000 times
Insulation resistance	≥ 20 MΩ (500 VDC== megger)
Noise immunity	± 2,000 VDC== the square wave noise (pulse width: 1 μs) by the noise simulator
Dielectric strength	1,000 VAC~ 50 / 60 Hz for 1 minute
Vibration	1.5 mm double amplitude at frequency of 10 to 55 Hz (for 1 minute) in each X, Y, Z direction for 2 hours
Shock	100 m/s ² (≈ 10 G) in each X, Y, Z direction for 3 times
Ambient illumination (receiver)	Sunlight: ≤ 3,000 lx, incandescent lamp: ≤ 3,000 lx
Ambient temperature	-20 to 50 °C, storage: -20 to 70 °C (no freezing or condensation)
Ambient humidity	35 to 85 %RH, storage: 35 to 85 %RH (no freezing or condensation)
Protection	IP50 (IEC standard)
Connection	Cable connector type
Material	Case: ABS, lens: acryl, lens cover: acryl
01) Do not use the load which is beyond the rated capacity of contact point of relay. It may cause bad insulation, contact fusion, bad contact, relay breakdown, and fire etc.	

Automatic Door Side Sensors

ADS-SE1/2 Series



Features

- Long sensing distance: 0 to 10 m
- High ambient intensity of illumination: max. 100,000 lx of sunlight
- Easy to connect the sensor head to the controller
- Easy sensitivity setting (automatic sensitivity setting by one push method)
- Self-diagnosis function
- Compact Size (W 77 × L 44 × H 24 mm)

Specifications

Model	ADS-SE1	ADS-SE2
Available sensor sets	1 channel	2 channels
Sensing distance	0 to 10 m	
Sensing target	Opaque materials	
Min. sensing target	≥ Ø 20 mm	
Sensing method	Through-beam type	
Response time	≈ 50 ms (from interrupted light)	
Output holding time	≈ 500 ms (from received light)	
Light source	Infrared LED (850 nm modulated)	
Indicator	OUT 1 indicator (red), OUT 2 indicator (green)	
Approval	CE ENEC	
Weight (packaged)	≈ 300 g (≈ 450 g)	
Power supply	12 - 24 VAC~ ± 10 %, 50 / 60 Hz / 12 - 24 VDC= ± 10 % (ripple P-P: ≤ 10 %)	
Power consumption	AC: ≤ 2 VA / DC: ≤ 50 mA	
Control output	Relay contact output	
Relay contact capacity ⁰¹⁾	50 VDC= 0.3 A (resistive load)	
Relay contact composition	1c	
Relay life cycle	Mechanical: ≥ 5,000,000 times, electrical: ≥ 100,000 times	
Insulation resistance	≥ 20 MΩ (500 VDC= megger)	
Vibration	1 mm double amplitude at frequency of 10 to 55 Hz (for 1 minute) in each X, Y, Z direction for 2 hours	
Shock	500 m/s ² (≈ 50 G) in each X, Y, Z direction for 3 times	
Ambient illumination (receiver)	Sunlight: ≤ 100,000 lx	
Ambient temperature	-20 to 55 °C, storage: -25 to 60 °C (no freezing or condensation)	
Ambient humidity	35 to 85 %RH, storage: 35 to 85 %RH (no freezing or condensation)	
Protection structure	IP30 (IEC standard)	
Connection	Cable connector type	
Sensor cable	Ø 2.4 mm, 1-wire, 5 m	
Wire spec.	AWG26 (0.16 mm, 7-core), insulator outer diameter: Ø 1.32 mm	
Material of the controller	Housing: ABS, cover: ABS, bolt: SCM (brass, Ni-plate)	
Material of the sensor	Holder: ABS, lens: PMMA, lens guide: PC, nut: PC	

01) Do not use the load which is beyond the rated capacity of contact point of relay.
It may cause bad insulation, contact fusion, bad contact, relay breakdown, and fire etc.



A7. Area Sensors

Area sensors are convenient, general purpose light screens used to detect passing of objects in specified areas.

A7-1	Area Sensors	BWC Series	Cross-Beam Area Sensors
		BW Series	Single-Beam Area Sensors
		BWP Series	Slim Plastic Single-Beam Area Sensors
		BWPK Series	Slim Plastic Single-Beam Picking Sensors
A7-2	Mapping Sensors	BWM Series	Double-Scan Mapping Sensors (CC-Link, EtherCAT)
		BWML Series	Line-Beam Mapping Sensors (CC-Link, EtherCAT)

Cross-Beam Area Sensors

BWC Series

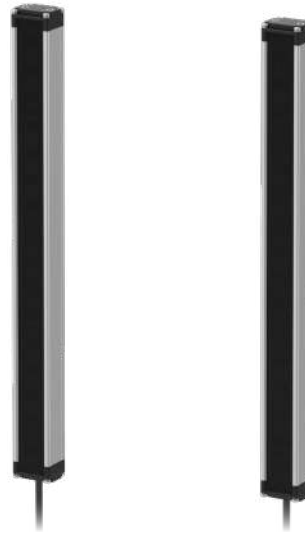

Features

- 3-point cross-beam type detection minimizes non-detection area
- Long sensing distance up to 7 m
- 14 configurations (number of optics: 4 to 20 / optical pitch: 40, 80 mm / detection area: 120 to 1,040 mm)
- Easy installation with installation mode function
- Mutual interference prevention function, self-diagnosis function
- Self-diagnosis output: sensing screen pollution and blocking of optical axis can be checked from external device
- Bright LED indicators on emitter and receiver
- Korean Railway Standard compliant (BWC80-14HD models)
- IP67 protection structure (IEC standard)

Specifications

Model	BWC40-□□H	BWC40-□□HD	BWC80-14H	BWC80-14HD
Sensing method	Through-beam			
Beam pattern	3-point cross beam netting type			
Light source	Infrared LED (850 nm modulated light)			
Sensing distance	1.0 to 7.0 m			
Sensing target	Opaque material			
Min. sensing target	≥ Ø 50 mm		≥ Ø 90 mm	
Number of optical axes	4 / 10 / 12 / 16 / 18 / 20		14	
Sensing height	120 to 760 mm		1,040 mm	
Optical axis pitch	40 mm		80 mm	
Response time	≤ 50 ms			
Operation mode	Light ON	Dark ON	Light ON	Dark ON
Functions	Self-diagnosis output (front screen pollution, covering optical axis), self-diagnosis			
Installation mode	YES			
Interference protection	Interference protection by frequency changing setting			
Synchronization type	Timing method by synchronous line			
Indicator	Emitter: Operation indicator (green, red), frequency indicator (green) Receiver: Operation indicator (red, yellow, green)			
Approval	CE ENEC	CE ENEC	CE ENEC	CE ENEC
Korean Railway Standards	-			KRS SG 0068
Weight (packaged)	≈ 1.7 kg (≈ 2.1 kg) (based on BWC80-14H)			
Power supply	12 - 24 VDC≐ (ripple P-P: ≤ 10 %)			
Current consumption	≤ 100 mA			
Control output	NPN open collector output			
Load voltage	≤ 30 VDC≐			
Load current	≤ 100 mA (self-diagnosis output: ≤ 50 mA)			
Residual voltage	≤ 1 VDC≐			
Protection circuit	Reverse power protection circuit, output short overcurrent protection circuit			
Insulation resistance	≥ 20 MΩ (500 VDC≐ megger)			
Noise immunity	± 240 V the square wave noise (pulse width: 1μs) by the noise simulator			
Dielectric strength	1,000 VAC~ 50 / 60 Hz for 1minute			
Vibration	1.5 mm double amplitude at frequency of 10 to 55 Hz (for 1 min) in each X, Y, Z direction for 2 hours			
Shock	500 m/s ² (≈ 50 G) in each X, Y, Z direction for 3 times			
Ambient illuminance	Ambient light: ≤ 100,000 lx			
Ambient temperature	-10 to 55 °C, storage: -20 to 60 °C (no freezing or condensation)			
Ambient humidity	35 to 85 %RH, storage: 35 to 85 %RH (no freezing or condensation)			
Protection rating	IP67 (IEC standard)			
Wire spec.	Ø 5 mm, 4-wire, 300 mm			
Connector spec.	M12 plug connector			
Material	Case: AL, sensing part and indicator: acryl			

Single-Beam Area Sensors

BW Series

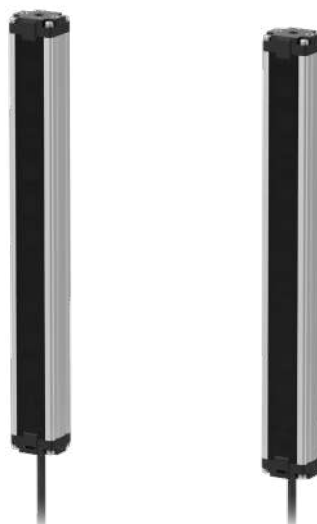

Features

- 20 mm optical pitch minimizes non-detection area (BW20-□)
- Long sensing distance up to 7 m
- 22 configurations (number of optics : 4 to 48 / optical pitch: 20, 40 mm / detection area: 120 to 940 mm)
- Mutual interference prevention function, self-diagnosis function, stable operation test
- Bright LED indicators on emitter and receiver
- Ambient illuminance : 100,000 lux (upgraded feature)
- IP65 protection structure (IEC standard)

Specifications

Model	BW20-□(P)	BW40-□(P)
Sensing method	Through-beam	
Light source	Infrared LED (850 nm modulated light)	
Sensing distance	0.1 to 7.0 m	
Sensing target	Opaque material	
Min. sensing target	≥ Ø 30 mm	≥ Ø 50 mm
Number of optical axes	8 to 48	4 to 24
Sensing height	140 to 940 mm	120 to 920 mm
Optical axis pitch	20 mm	40 mm
Response time	≤ 10 ms	
Operation mode	Light ON	
Functions	Emitter OFF (external diagnosis), self-diagnosis	
Interference protection	Interference protection by MASTER / SLAVE function ⁰¹⁾	
Synchronization type	Timing method by synchronous line	
Indicator	Emitter: Operation indicator (green, red), receiver: Operation indicator (red, yellow, green)	
Approval	CE ENEC	CE ENEC
Weight (packaged)	≈ 1.4 kg (≈ 2.1 kg) (based on BW20-48)	≈ 1.4 kg (≈ 2.1 kg) (based on BW40-24)
<small>01) Connect 'TEST/M/S' of SLAVE emitter to 'SYNC' of MASTER. Refer to the product manual.</small>		
Power supply	12 - 24 VDC≐ (ripple P-P: ≤ 10 %)	
Current consumption	Emitter / receiver: ≤ 120 mA	
Control output	NPN or PNP open collector output	
Load voltage	≤ 30 VDC≐	
Load current	≤ 100 mA	
Residual voltage	NPN: ≤ 1 VDC≐, PNP: ≤ 2.5 VDC≐	
Protection circuit	Reverse power protection circuit, output short overcurrent protection circuit	
Insulation resistance	≥ 20 MΩ (500 VDC≐ megger)	
Noise immunity	± 240 V the square wave noise (pulse width 1μs) by the noise simulator	
Dielectric strength	1,000 VAC~ 50 / 60 Hz for 1minute	
Vibration	1.5 mm double amplitude at frequency of 10 to 55 Hz (for 1 min) in each X, Y, Z direction for 2 hours	
Shock	500 m/s ² (≈ 50 G) in each X, Y, Z direction for 3 times	
Ambient illumination (receiver)	Ambient light: ≤ 100,000 lx	
Ambient temperature	-10 to 55 °C, storage: -20 to 60 °C (no freezing or condensation)	
Ambient humidity	35 to 85 %RH, storage: 35 to 85 %RH (no freezing or condensation)	
Protection rating	IP65 (IEC standard)	
Cable spec.	Ø 5 mm, 4-wire, 300 mm	
Connector spec.	M12 plug connector	
Material	Case: AL, front cover and sensing part: acryl	

Slim Plastic Single-Beam Area Sensors

BWP Series



Features

- Flat body (13 mm) area sensors with Fresnel lens
- High strength PC / ABS plastic body
- High-speed response time under 7ms
- 4 configurations (optical axis: 8 to 20, detection area: 140 to 380 mm)
- Operation test (emitter stop) function, mutual interference prevention function, Job indicator ON/FLASHING switch, Light ON / Dark ON operation mode switch
- Bright LED indicators on emitter and receiver
- IP40 protection structure (IEC standard)

Specifications

Model	BWP20-08(P)	BWP20-12(P)	BWP20-16(P)	BWP20-20(P)
Sensing method	Through-beam			
Light source	Infrared LED (850 nm modulated light)			
Sensing distance	0.1 to 5.0 m			
Sensing target	Opaque material			
Min. sensing target	≥ Ø 30 mm			
Number of optical axes	8	12	16	20
Sensing height	140 mm	220 mm	300 mm	380 mm
Optical axis pitch	20 mm			
Response time	≤ 6 ms (frequency B: ≤ 7 ms)			
Operation mode	Light ON / Dark ON (switch)			
Functions	Emitter OFF, operation mode change, Job indicator ON / flashing			
Interference protection	Interference protection by transmission frequency selection			
Synchronization type	Timing method by synchronous line			
Indicator	Emitter: frequency A indicator (green), frequency B indicator (yellow) Receiver: operation indicator (red), stable indicator (green) Emitter / receiver: Job indicator (red)			
Approval	CE ENEC		CE ENEC	
Weight (packaged)	≈ 280 g (≈ 480 g)	≈ 320 g (≈ 520 g)	≈ 360 g (≈ 620 g)	≈ 430 g (≈ 680 g)
Power supply	12 - 24 VDC≒ (ripple P-P: ≤ 10 %)			
Current consumption	Emitter / receiver: ≤ 80 mA			
Control output	NPN / PNP open collector output model			
Load voltage	≤ 30 VDC≒			
Load current	≤ 150 mA			
Residual voltage	NPN: ≤ 1 VDC≒, PNP: ≤ 2.5 VDC≒			
Protection circuit	Reverse power protection circuit, output short overcurrent protection circuit			
Insulation resistance	≥ 20 MΩ (500 VDC≒ megger)			
Noise immunity	± 240 V the square wave noise (pulse width: 1μs) by the noise simulator			
Dielectric strength	1,000 VAC~ 50 / 60 Hz for 1minute			
Vibration	1.5 mm double amplitude at frequency of 10 to 55 Hz (for 1 min) in each X, Y, Z direction for 2 hours			
Shock	500 m/s ² (≈ 50 G) in each X, Y, Z direction for 3 times			
Ambient illumination (receiver)	Ambient light: ≤ 100,000 lx			
Ambient temperature	-10 to 55 °C, storage: -20 to 60 °C (no freezing or condensation)			
Ambient humidity	35 to 85 %RH, storage: 35 to 85 %RH (no freezing or condensation)			
Protection rating	IP40 (IEC standard)			
Cable spec.	Ø 3.5 mm, 4-wire, 3 m			
Wire spec.	AWG 24 (0.08 mm, 40-core), insulator diameter: Ø 1 mm			
Material	Case: PC / ABS, sensing part: PMMA			

Slim Plastic Single-Beam Picking Sensors

BWPK Series



Features

- Flat and compact size:
W 30 × H 140 × D 9.9 mm
- High strength PC / ABS plastic body
- Sensing distance switch
(long / short mode switch)
- Mutual interference prevention function
(frequency switching), Picking indicators
on emitter and receiver, Light ON / Dark ON
operation mode switch
- IP40 protection structure (IEC standard)

Specifications

Model	BWPK25-05(P)
Sensing method	Through-beam
Light source	Infrared LED (850 nm modulated light)
Sensing distance	Long / Short mode (switch)
Long mode	0.1 to 3.0 m
Short mode	0.05 to 1.0 m
Sensing target	Opaque material
Min. sensing target	≥ Ø 35 mm
Number of optical axes	5
Sensing height	100 mm
Optical axis pitch	25 mm
Response time	≤ 30 ms
Operation mode	Light ON / Dark ON (switch)
Functions	Selection for sensing distance, selection for operation mode, Picking indicator ON / flashing
Interference protection	Interference protection by transmission frequency selection
Synchronization type	Timing method by synchronous line
External picking input	Non-contact or contact input NPN open collector output: lighting (0 - 2 V), light out (5 - 30 V or open) PNP open collector output: lighting (4 - 30 V), light out (0 - 3 V or open)
Indicator	Emitter / receiver: operation indicator (red, green, yellow)
Approval	CE ENEC
Weight (packaged)	≈ 180 g (≈ 220 g)
Power supply	12 - 24 VDC≐ (ripple P-P: ≤ 10 %)
Current consumption	Emitter / receiver: ≤ 60 mA
Control output	NPN / PNP open collector output model
Load voltage	≤ 30 VDC≐
Load current	≤ 150 mA
Residual voltage	NPN: ≤ 1 VDC≐, PNP: ≤ 2.5 VDC≐
Protection circuit	Reverse power protection circuit, output short overcurrent protection circuit
Insulation resistance	≥ 20 MΩ (500 VDC≐ megger)
Noise immunity	± 240 V the square wave noise (pulse width: 1μs) by the noise simulator
Dielectric strength	1,000 VAC~ 50 / 60 Hz for 1minute
Vibration	1.5 mm double amplitude at frequency of 10 to 55 Hz (for 1 min) in each X, Y, Z direction for 2 hours
Shock	500 m/s ² (≈ 50 G) in each X, Y, Z direction for 3 times
Ambient illum. (receiver)	Sunlight: 10,000 lx, incandescent lamp: 3,000 lx
Ambient temp.	-10 to 55 °C, storage: -20 to 60 °C (no freezing or condensation)
Ambient humi.	35 to 85 %RH, storage: 35 to 85 %RH (no freezing or condensation)
Protection rating	IP40 (IEC standard)
Cable spec.	Ø 4 mm, 4-wire, 2 m (emitter: 3-wire)
Wire spec.	AWG 22 (0.08 mm, 60-core), insulator diameter: Ø 1.25 mm
Material	Case: PC / ABS, sensing part: PMMA

Double-Scan Mapping Sensors

(CC-Link, EtherCAT)

BWM Series



Features

- Stable glass substrate detection with using double scan method
- Sensing distance: glass G size +30 %
- Customized models available: sensing channels (4 to 62 channels), optical axis pitch (25 to 200 mm)
- Communication output: CC-Link (ver 1.1, 2.0), EtherCAT
- Easy installation with installation instruction mode
- Mutual interference prevention, bent optical axis alarm, 9-stage sensing level setting, emitter error alarm
- Bright status indicators on slave units

Specifications

Model	BWM
Sensing method	Through-beam
Beam pattern	Double scan type
Light source	Infrared LED (850 nm modulated light)
Sensing distance	Glass + 30 %
Sensing target	Transparent or opaque glass plate
CH ordering orientation⁰¹⁾	Forward (bottom = 1 CH) / Backward (top = 1 CH)
Sensing CH⁰¹⁾	4 to 62 CH
Optical axis pitch⁰¹⁾	25 to 200 mm
Response time	≤ 120 ms
Operation mode⁰¹⁾	Light ON / Dark ON
Function	Installation guide mode, sensing level setting, optical axis misalignment alarm (low light intensity alarm), emitter damage alarm, self-diagnosis
Interference protection	Interference protection by transmission frequency selection
Synchronization type	Timing method by synchronous line
Indicator	Output indicator (red), stability indicator (green), status indicator (green, yellow, red)
Approval	CE  ⁰²⁾
Weight (packaged)	CC-Link: ≈3.2 kg (≈ 5.3 kg) (based on BWM82-24CLD-T, BWM28-50ECD-T) EtherCAT: ≈3.42 kg (≈ 5.52 kg) (based on BWM28-50ECD-T)

01) This product is order made.

02) Please refer to the website for KC certification model.

Power supply	24 VDC≐ (ripple P-P: ≤ 10 %)
Current consumption	Master: ≤ 200 mA, slave: ≤ 150 mA
Protection circuit	Reverse power protection circuit, output short overcurrent protection circuit
Insulation resistance	≥ 20 MΩ (500 VDC≐ megger)
Noise immunity	The square wave noise by the noise simulator (voltage: 500 V, period: 10 ms, pulse width: 1 us)
Dielectric strength	Between all power input terminals and F.G. terminal : 500 VAC~ 50 / 60 Hz for 1 min Between all CC-Link communication input terminals and F.G. terminal: 1,000 VAC~ 50 / 60 Hz for 1 min Between all power input terminals and CC-Link communication input terminals: 1,000 VAC~ 50 / 60 Hz for 1 min
Vibration	1.5 mm double amplitude at frequency of 10 to 55 Hz (for 1 min) in each X, Y, Z direction for 2 hours
Shock	210 m/s ² (≈ 21 G) in each X, Y, Z direction for 3 times
Ambient illumination	Light bulb: 5,000 lx, semiconductor: 5,000 lx
Ambient temperature	15 to 35 °C, storage: 15 to 35 °C (no freezing or condensation)
Ambient humidity	35 to 85 %, storage: 35 to 85 % (no freezing or condensation)
Cable spec.	∅ 5 mm, 6-wire, 250 mm
Connector spec.	M17 plug connector
Output connector spec.	Connector type: 4-pin, 6-pin connector (5.08 mm pitch) / terminal type: 10-pin terminal
Material	Case: AL / ABS, sensing part and Indicator part: PMMA
Comm. protocol	CC-Link, EtherCAT

Line-Beam Mapping Sensors (CC-Link, EtherCAT)

BWML Series



Features

- Stable glass substrate detection using line beam detection with minimal non-detection area
- Sensing distance: 95 ± 10 mm
- Customized models available: sensing channels (4 to 62 CH), sensing target pitch (≥ 20 mm), sensing area (280 to 1,775 mm)
- Communication output: CC-Link (ver 1.1, 2.0)
- Easy installation with installation instruction mode and background sensing mode
- Channel interference alarm, 5-stage sensing level setting, emitter / receiver error alarm
- Bright status indicators

Specifications

Model	BWML
Sensing method	Diffuse reflective type
Beam pattern	Line-beam type
Light source	Infrared LED (850 nm modulated light)
Sensing distance	95 mm ± 10 mm
Sensing target	Transparent or opaque glass plate
CH ordering orientation ⁰¹⁾	Forward (bottom = 1 CH) / Backward (top = 1 CH) (parameter setting)
Sensing CH ⁰¹⁾	4 to 62 CH
Sensing target pitch ⁰¹⁾	20 mm to ordered specification
Response time	≤ 120 ms
Operation mode ⁰¹⁾	Light ON / Dark ON (parameter setting)
Function	Background sensing mode, installation guide mode, sensing level setting, output option, self-diagnosis
Indicator	Output indicator (red), stability indicator (green), status indicator (green, yellow, red)
Approval	CE ⁰²⁾ CC-Link
Weight (packaged)	≈ 3.64 kg (≈ 4.8 kg) (based on BWML82-20CLL, BWML82-20ECL)
Power supply	24 VDC= (ripple P-P: ≤ 10 %)
Current consumption	≤ 1.0 A
Protection circuit	Reverse power protection circuit, output short overcurrent protection circuit
Insulation resistance	≥ 20 MΩ (500 VDC= megger)
Noise immunity	The square wave noise by the noise simulator (voltage: 500 V, period: 10 ms, pulse width: 1 us)
Dielectric strength	Between all power input terminals and F.G. terminal : 500 VAC~ 50 / 60 Hz for 1 min Between communication input terminals and F.G. terminal : 1,000 VAC~ 50 / 60 Hz for 1 min Between power input terminals and communication input terminals: 1,000 VAC~ 50 / 60 Hz for 1 min
Vibration	1.5 mm double amplitude at frequency of 10 to 55 Hz (for 1 min) in each X, Y, Z direction for 2 hours
Shock	210 m/s ² (≈ 21 G) in each X, Y, Z direction for 3 times
Ambient temperature	15 to 35 °C, storage: -10 to 50 °C (no freezing or condensation)
Ambient humidity	35 to 55 %, storage: 35 to 85 % (no freezing or condensation)
Protection rating	IP40 (IEC standard)
Material	Case: AL, sensing part and Indicator part: PMMA
Comm. protocol	CC-Link, EtherCAT

01) This product is order made.

02) Please refer to the website for KC certification model.



A8. Proximity Sensors

Proximity sensors are common, reliable, and durable solutions for applications requiring non-contact detection.

A8-1	Inductive	PRD Series	Cylindrical Inductive Long-Distance Proximity Sensors (DC 3-Wire)
			Cylindrical Inductive Long-Distance Proximity Sensors (DC 2-Wire)
			Cylindrical Inductive Long-Distance Proximity Sensors (IO-Link)
		PR Series	Cylindrical Inductive Proximity Sensors (DC 3-Wire)
			Cylindrical Inductive Proximity Sensors (DC 2-Wire)
			Cylindrical Inductive Proximity Sensors (AC 2-Wire)
		PRFD Series	Cylindrical Inductive Full-Metal Long-Distance Proximity Sensors (DC 2-Wire)
		PRF Series	Cylindrical Inductive Full-Metal Proximity Sensors (DC 2-Wire)
		PET Series	Cylindrical Inductive Transmission Couplers
		PS Series	Rectangular Inductive Proximity Sensors (DC 3-Wire, □ 8 / 12 / 50 mm)
			Rectangular Inductive Proximity Sensors (DC 3-Wire, □ 17 / 25 / 30 / 40 mm)
			Rectangular Inductive Proximity Sensors (DC 2-Wire)
			Rectangular Inductive Proximity Sensors (AC 2-Wire)
AS Series	Rectangular Inductive Long-Distance Proximity Sensors (DC 4-Wire)		
PFI Series	Rectangular Flat-Type Inductive Proximity Sensors (DC 3-Wire)		
	Rectangular Flat-Type Inductive Proximity Sensors (AC 2-Wire)		
A8-2	Capacitive	CR Series	Cylindrical Capacitive Proximity Sensors (DC 3-Wire)
			Cylindrical Capacitive Proximity Sensors (AC 2-Wire)
A8-3	Magnetic	MU Series	U-Shaped Magnetic Proximity Sensors

Cylindrical Inductive Long-Distance Proximity Sensors (DC 3-Wire)

PRD Series



Features

- Spatter-resistant type:
PTFE coated for high heat resistance
(prevent malfunction from welding spatter)
- Operation indicator (red LED)
- IP67 Protection structure (IEC standards)
- Strain relief cables:
improved flexural strength of
cable connecting component
(except DIA. of sensing side \varnothing 8 mm)

Specifications

Installation	Flush type			
General	PRD□08-2D □	PRD□12-4D □	PRD□18-7D □	PRD□30-15D □
Spatter-resistant	-	PRDADM12-4D □	PRDADM18-7D □	PRDADM30-15D □
DIA. of sensing side	\varnothing 8 mm	\varnothing 12 mm	\varnothing 18 mm	\varnothing 30 mm
Sensing distance	2 mm	4 mm	7 mm	15 mm
Setting distance	0 to 1.4 mm	0 to 2.8 mm	0 to 4.9 mm	0 to 10.5 mm
Hysteresis	\leq 15 % of sensing distance	\leq 10 % of sensing distance		
Standard sensing target: iron	8 × 8 × 1 mm	12 × 12 × 1 mm	20 × 20 × 1 mm	45 × 45 × 1 mm
Response frequency ⁰¹⁾	1 kHz	500 Hz	300 Hz	100 Hz
Affection by temperature	\leq \pm 10 % for sensing distance at ambient temperature 20 °C (DIA. of sensing side \varnothing 8 mm: \leq \pm 15 %)			
Indicator	Operation indicator (red)			
Approval	CE EAC	CE EAC	CE EAC	CE EAC
Installation	Non-flush type			
General	PRD□08-4D □	PRD□12-8D □	PRD□18-14D □	PRD□30-25D □
DIA. of sensing side	\varnothing 8 mm	\varnothing 12 mm	\varnothing 18 mm	\varnothing 30 mm
Setting distance	0 to 2.8 mm	0 to 5.6 mm	0 to 9.8 mm	0 to 17.5 mm
Sensing distance	4 mm	8 mm	14 mm	25 mm
Hysteresis	\leq 15 % of sensing distance	\leq 10 % of sensing distance		
Standard sensing target: iron	12 × 12 × 1 mm	25 × 25 × 1 mm	40 × 40 × 1 mm	75 × 75 × 1 mm
Response frequency ⁰¹⁾	800 Hz	400 Hz	200 Hz	100 Hz
Affection by temperature	\leq \pm 10 % for sensing distance at ambient temperature 20 °C (DIA. of sensing side \varnothing 8 mm: \leq \pm 15 %)			
Indicator	Operation indicator (red)			
Approval	CE EAC	CE EAC	CE EAC	CE EAC

01) The response frequency is the average value. The standard sensing target is used and the width is set as 2 times of the standard sensing target, 1/2 of the sensing distance for the distance.

Unit weight (package)		\varnothing 8 mm	\varnothing 12 mm	\varnothing 18 mm	\varnothing 30 mm
Cable	Normal	\approx 43 g (\approx 63 g)	\approx 62 g (\approx 74 g)	\approx 97 g (\approx 115 g)	\approx 143 g (\approx 180 g)
	Long	-	\approx 82 g (\approx 94 g)	\approx 127 g (\approx 145 g)	\approx 183 g (\approx 220 g)
Cable connector	Normal	\approx 25 g (\approx 45 g)	\approx 37 g (\approx 67 g)	\approx 62 g (\approx 80 g)	\approx 108 g (\approx 145 g)
	Long	-	\approx 32 g (\approx 55 g)	\approx 92 g (\approx 110 g)	\approx 130 g (\approx 203 g)
Connector	Normal	\approx 12 g (\approx 32 g)	\approx 20 g (\approx 49 g)	\approx 41 g (\approx 81 g)	\approx 138 g (\approx 197 g)
	Long	-	\approx 24 g (\approx 54 g)	\approx 60 g (\approx 78 g)	\approx 193 g (\approx 252 g)

Power supply	12 - 24 VDC \pm (ripple P-P: \leq 10 %), operating voltage: 10 - 30 VDC \pm
Current consumption	\leq 10 mA
Control output	\leq 200 mA
Residual voltage	DIA. of sensing side \varnothing 8mm: \leq 2 V DIA. of sensing side \varnothing 12 mm, \varnothing 18 mm, \varnothing 30 mm: \leq 1.5 V
Protection circuit	Surge protection circuit, output short over current protection circuit, reverse polarity protection
Insulation resistance	\geq 50 M Ω (500 VDC \pm megger)
Dielectric strength	DIA. of sensing side \varnothing 8mm : 1,000 VAC \sim 50/60 Hz for 1 min (between all terminals and case) (connector type: 1,500 VAC \sim 50/60 Hz for 1 min (between all terminals and case)) DIA. of sensing side \varnothing 12 mm, \varnothing 18 mm, \varnothing 30 mm : 1,500 VAC \sim 50/60 Hz for 1 min (between all terminals and case)
Vibration	1 mm double amplitude at frequency 10 to 55 Hz (for 1 min) in each X, Y, Z direction for 2 hours
Shock	500 m/s ² (\approx 50 G) in each X, Y, Z direction for 3 times
Ambient temperature	-25 to 70 °C, storage: -30 to 80 °C (non-freezing or non-condensation)
Ambient humidity	35 to 95 %RH, storage: 35 to 95 %RH (non-freezing or non-condensation)
Protection structure	IP67 (IEC standards)
Connection	Cable type ⁰¹⁾ / Cable connector type ⁰¹⁾ / Connector type model
Cable spec.⁰²⁾	DIA. of sensing side \varnothing 8 mm: \varnothing 3.5 mm, 3-wire DIA. of sensing side \varnothing 12 mm: \varnothing 4 mm, 3-wire DIA. of sensing side \varnothing 18 mm, \varnothing 30 mm: \varnothing 5 mm, 3-wire
Wire spec.	\varnothing 3.5 mm cable : AWG 24 (0.08 mm, 40-core), insulator diameter: \varnothing 1 mm \varnothing 4 mm, \varnothing 5 mm cable : AWG 22 (0.08 mm, 60-core), insulator diameter: \varnothing 1.25 mm
Connector spec.	M12 connector
Material	Standard type cable (black): polyvinyl chloride (PVC) Oil resistant cable (gray): polyvinyl chloride (oil resistant PVC)
General	Case/Nut: nickel plated brass (DIA. of sensing side \varnothing 8 mm connector type case: SUS303), washer: nickel plated iron, sensing side: PBT
Spatter-resistant	Case/Nut: PTFE coated brass, washer: PTFE coated iron, sensing side: PTFE

01) Except spatter-resistant type

02) Cable type: 2 m, Cable connector type: 300 mm

Cylindrical Inductive Long-Distance Proximity Sensors (DC 2-Wire)

PRD Series



Features

- Spatter-resistant type:
PTFE coated for high heat resistance
(prevent malfunction from welding spatter)
- Operation indicator (red LED)
- IP67 Protection structure (IEC standards)
- Strain relief cables:
improved flexural strength of
cable connecting component
(except DIA. of sensing side Ø 8 mm)

Specifications

Installation	Flush type			
General	PRD□T08-2 □	PRD□T12-4 □	PRD□T18-7 □	PRD□T30-15 □
Spatter-resistant	-	PRDA□T12-4 □	PRDA□T18-7 □	PRDA□T30-15 □
DIA. of sensing side	Ø 8 mm	Ø 12 mm	Ø 18 mm	Ø 30 mm
Sensing distance	2 mm	4 mm	7 mm	15 mm
Setting distance	0 to 1.4 mm	0 to 2.8 mm	0 to 4.9 mm	0 to 10.5 mm
Hysteresis	≤ 15 % of sensing distance			
Standard sensing target: iron	8 × 8 × 1 mm	12 × 12 × 1 mm	20 × 20 × 1 mm	45 × 45 × 1 mm
Response frequency ⁰¹⁾	1 kHz	450 Hz	250 Hz	100 Hz
Affection by temperature	≤ ± 10 % for sensing distance at ambient temperature 20 °C (DIA. of sensing side Ø 8 mm: ≤ ± 15 %)			
Indicator	Operation indicator (red)			
Approval	CE EAC	CE EAC	CE EAC	CE EAC

Installation	Non-flush type			
General	PRD□T08-4 □	PRD□T12-8 □	PRD□T18-14 □	PRD□T30-25 □
DIA. of sensing side	Ø 8 mm	Ø 12 mm	Ø 18 mm	Ø 30 mm
Sensing distance	4 mm	8 mm	14 mm	25 mm
Setting distance	0 to 2.8 mm	0 to 5.6 mm	0 to 9.8 mm	0 to 17.5 mm
Hysteresis	≤ 15 % of sensing distance			
Standard sensing target: iron	12 × 12 × 1 mm	25 × 25 × 1 mm	40 × 40 × 1 mm	75 × 75 × 1 mm
Response frequency ⁰¹⁾	800 Hz	400 Hz	200 Hz	100 Hz
Affection by temperature	≤ ± 10 % for sensing distance at ambient temperature 20 °C (DIA. of sensing side Ø 8 mm: ≤ ± 15 %)			
Indicator	Operation indicator (red)			
Approval	CE EAC	CE EAC	CE EAC	CE EAC

01) The response frequency is the average value. The standard sensing target is used and the width is set as 2 times of the standard sensing target, 1/2 of the sensing distance for the distance.

Unit weight (package) ⁰¹⁾		Ø 8 mm	Ø 12 mm	Ø 18 mm	Ø 30 mm
Cable	Normal	≈ 43 g (≈ 63 g)	≈ 62 g (≈ 74 g)	≈ 97 g (≈ 115 g)	≈ 143 g (≈ 180 g)
	Long	-	≈ 72 g (≈ 84 g)	≈ 122 g (≈ 134 g)	≈ 221 g (≈ 184 g)
Cable connector	Normal	≈ 25 g (≈ 45 g)	≈ 32 g (≈ 55 g)	≈ 62 g (≈ 80 g)	≈ 130 g (≈ 145 g)
	Long	-	≈ 42 g (≈ 54 g)	≈ 65 g (≈ 77 g)	≈ 143 g (≈ 155 g)
Connector	Normal	≈ 10 g (≈ 32 g)	≈ 20 g (≈ 50 g)	≈ 42 g (≈ 60 g)	≈ 110 g (≈ 150 g)
	Long	-	≈ 26 g (≈ 38 g)	≈ 49 g (≈ 61 g)	≈ 134 g (≈ 146 g)
		-	-	≈ 60 g (≈ 78 g)	≈ 150 g (≈ 190 g)

01) In case of normal body length, it is written in General type order. In case of long body length, it is only available Spatter-resistant type.

Power supply	12 - 24 VDC \pm (ripple P-P: \leq 10 %), operating voltage: 10 - 30 VDC \pm
Leakage current	DIA. of sensing side \varnothing 8mm: \leq 0.8 mA DIA. of sensing side \varnothing 12 mm, \varnothing 18 mm, \varnothing 30 mm: \leq 0.6 mA
Control output	2 to 100 mA
Residual voltage ⁰¹⁾	\leq 3.5 V (Non-polarity: \leq 5 V)
Protection circuit	Surge protection circuit, output short over current protection circuit, reverse polarity protection
Insulation resistance	\geq 50 M Ω (500 VDC \pm megger)
Dielectric strength	DIA. of sensing side \varnothing 8 mm : 1,000 VAC \sim 50/60 Hz for 1 min (between all terminals and case) (connector type: 1,500 VAC \sim 50/60 Hz for 1 min (between all terminals and case)) DIA. of sensing side \varnothing 12 mm, \varnothing 18 mm, \varnothing 30 mm : 1,500 VAC \sim 50/60 Hz for 1 min (between all terminals and case)
Vibration	1 mm double amplitude at frequency 10 to 55 Hz (for 1 min) in each X, Y, Z direction for 2 hours
Shock	500 m/s ² (\approx 50 G) in each X, Y, Z direction for 3 times
Ambient temperature	-25 to 70 °C, storage: -30 to 80 °C (non-freezing or non-condensation)
Ambient humidity	35 to 95 %RH, storage: 35 to 95 %RH (non-freezing or non-condensation)
Protection structure	IP67 (IEC standards)
Connection	Cable type / Cable connector type / Connector type model
Cable spec. ⁰²⁾	DIA. of sensing side \varnothing 8 mm: \varnothing 3.5 mm, 2-wire DIA. of sensing side \varnothing 12 mm: \varnothing 4 mm, 2-wire DIA. of sensing side \varnothing 18 mm, \varnothing 30 mm: \varnothing 5 mm, 2-wire
Wire spec.	\varnothing 3.5 mm cable : AWG 24 (0.08 mm, 40-core), insulator diameter: \varnothing 1 mm \varnothing 4 mm, \varnothing 5 mm cable : AWG 22 (0.08 mm, 60-core), insulator diameter: \varnothing 1.25 mm
Connector spec.	M12 connector
Material	Standard type cable (black): polyvinyl chloride (PVC) Oil resistant cable (gray): polyvinyl chloride (oil resistant PVC)
General	Case/Nut: nickel plated brass (DIA. of sensing side \varnothing 8 mm connector type case: SUS303), washer: nickel plated iron, sensing side: PBT
Spatter-resistant	Case/Nut: PTFE coated brass, washer: PTFE coated iron, sensing side: PTFE

01) Check the condition of connected device.

02) Cable type: 2 m, Cable connector type: 300 mm

Cylindrical Inductive Long-Distance Proximity Sensors (IO-Link)

PRD Series



Features

- Reduced installation work by identifying object IDs
- Malfunction and damage prevention through status monitoring
- Shortest time recovery through abnormal detection
- Mode indicator for check status
- IO-Link mode: Communication indicator (flashing green), operation indicator (orange), abnormal detect indicator (cross-flashing green, orange)
- SIO mode: Operation indicator (orange), stable indicator (green), abnormal detect indicator (cross-flashing green, orange)
- IP67 Protection rating (IEC standard)

Specifications

Installation	Flush type		
Model	PRD□12-4D-□-IL2	PRD□18-7D-□-IL2	PRD□30-15D-□-IL2
DIA. of sensing side	Ø 12 mm	Ø 18 mm	Ø 30 mm
Sensing distance	4 mm	7 mm	15 mm
Setting distance	0 to 2.8 mm	0 to 4.9 mm	0 to 10.5 mm
Hysteresis	≤ 10 % of sensing distance		
Standard sensing target: iron	12 × 12 × 1 mm	20 × 20 × 1 mm	45 × 45 × 1 mm
Response frequency ⁰¹⁾	500 Hz	250 Hz	100 Hz
Affection by temperature	≤ ± 10 % for sensing distance at ambient temperature 20 °C		
Indicator ⁰²⁾	IO-Link mode, SIO mode		
IO-Link mode	Communication indicator (flashing green), operation indicator (orange), Abnormal detect indicator (cross-flashing green, orange)		
SIO mode	Operation indicator (orange), stable indicator (green), Abnormal detect indicator (cross-flashing green, orange)		
Approval	CE	CE	CE

01) The response frequency is the average value. The standard sensing target is used and the width is set as 2 times of the standard sensing target, 1/2 of the sensing distance for the distance.

02) In case of SIO mode, use the device within the range where the stable indicator (green) is ON.
If the sensing target is in the too close detection distance, the stable indicator turns OFF, but it is in a stable detection state.
In case of IO-Link mode, use the device within the range where unstable detection (Byte0_bit6) turns 0.
If the sensing target is in the too close detection distance, the too close detection (Byte0_bit5) is 1, but it is a stable detection state.

Installation	Non-flush type		
Model	PRD□12-8D-□-IL2	PRD□18-14D-□-IL2	PRD□30-25D-□-IL2
DIA. of sensing side	Ø 12 mm	Ø 18 mm	Ø 30 mm
Sensing distance	8 mm	14 mm	25 mm
Setting distance	0 to 5.6 mm	0 to 9.8 mm	0 to 17.5 mm
Hysteresis	≤ 10 % of sensing distance		
Standard sensing target: iron	25 × 25 × 1 mm	40 × 40 × 1 mm	75 × 75 × 1 mm
Response frequency ⁰¹⁾	400 Hz	200 Hz	100 Hz
Affection by temperature	≤ ± 10 % for sensing distance at ambient temperature 20 °C		
Indicator ⁰²⁾	IO-Link mode, SIO mode		
IO-Link mode	Communication indicator (flashing green), operation indicator (orange), Abnormal detect indicator (cross-flashing green, orange)		
SIO mode	Operation indicator (orange), stable indicator (green), Abnormal detect indicator (cross-flashing green, orange)		
Approval	CE	CE	CE

01) The response frequency is the average value. The standard sensing target is used and the width is set as 2 times of the standard sensing target, 1/2 of the sensing distance for the distance.

02) In case of SIO mode, use the device within the range where the stable indicator (green) is ON.
If the sensing target is in the too close detection distance, the stable indicator turns OFF, but it is in a stable detection state.
In case of IO-Link mode, use the device within the range where unstable detection (Byte0_bit6) turns 0.
If the sensing target is in the too close detection distance, the too close detection (Byte0_bit5) is 1, but it is a stable detection state.

Unit weight (package)	Ø 12 mm	Ø 18 mm	Ø 30 mm
Cable	≈ 62 g (≈ 74 g)	≈ 97 g (≈ 115 g)	≈ 143 g (≈ 180 g)
Cable connector	≈ 37 g (≈ 67 g)	≈ 62 g (≈ 80 g)	≈ 108 g (≈ 145 g)
Connector	≈ 20 g (≈ 49 g)	≈ 41 g (≈ 81 g)	≈ 138 g (≈ 197 g)

Power supply	12 - 24 VDC \equiv (ripple P-P: \leq 10 %), operating voltage: 10 - 30 VDC \equiv
Current consumption	IO-Link mode: \leq 25 mA, SIO mode: \leq 20 mA
Control output	\leq 100 mA
Residual voltage ⁰¹⁾	\leq 2 V
Protection circuit	Surge protection circuit, output short over current protection circuit, reverse polarity protection
Insulation resistance	\geq 50 M Ω (500 VDC \equiv megger)
Dielectric strength	1,000 VAC \sim 50 / 60 Hz for 1 min
Vibration	1.5 mm double amplitude at frequency 10 to 55 Hz (for 1 min) in each X, Y, Z direction for 2 hours
Shock	1000 m/s ² (\approx 100 G) in each X, Y, Z direction for 3 times
Ambient temp. ⁰²⁾	-25 to 70 °C, storage: -25 to 70 °C (no freezing or condensation)
Ambient humi.	35 to 95 %RH, storage: 35 to 95 %RH (no freezing or condensation)
Protection rating	IP67 (IEC standard)
Connection	Cable / Cable connector / connector models
Cable spec. ⁰³⁾	DIA. of sensing side \varnothing 12 mm: \varnothing 4 mm, 4-wire DIA. of sensing side \varnothing 18 mm, \varnothing 30 mm : \varnothing 5 mm, 4-wire
Wire spec.	AWG 22 (0.08 mm, 60-core), insulator diameter: \varnothing 1.25 mm
Connector spec.	M12 plug connector
Material	Standard type cable (black): polyvinyl chloride (PVC), Oil resistant cable (gray): polyvinyl chloride (oil resistant PVC), case / nut: nickel plated brass, washer: nickel plated iron, sensing side: PBT
Comm. protocol	IO-Link

01) Load current: 100 mA, cable length: 2 m

02) UL approved surrounding air temperature 40 °C

03) Cable type: 2 m, Cable connector type: 300 mm

Software

Download the installation file and the manuals from the Autonics website.

[atIOLink]

atIOLink with purposes for setting, diagnosis, and maintenance of IO-Link device via IODD file is provided as the Port and Device Configuration Tool (PDCT).

[IODD (IO Device Description)]

This file contains information such as manufacturer information, process data, diagnostic data, and parameter setting of a sensor using IO-Link communication. By uploading the IODD file to PDCT Software, you can check the setting and communication data according to the user interface. Download the IODD file from the Autonics website.

Cylindrical Inductive Proximity Sensors

(DC 3-Wire)

PR Series



Features

- Spatter-resistant type:
PTFE coated for high heat resistance
(prevent malfunction from welding spatter)
- Operation indicator (red LED)
- IP67 Protection structure (IEC standards)

Specifications

Installation	Flush type			
General	PR□08-1.5D □	PR□12-2D □	PR□18-5D □	PR□30-10D □
Spatter-resistant	-	PRA□12-2D □	PRA□18-5D □	PRA□30-10D □
DIA. of sensing side	Ø 8 mm	Ø 12 mm	Ø 18 mm	Ø 30 mm
Sensing distance	1.5 mm	2 mm	5 mm	10 mm
Setting distance	0 to 1.05 mm	0 to 1.4 mm	0 to 3.5 mm	0 to 7 mm
Hysteresis	≤ 10 % of sensing distance (DIA. of sensing side Ø 8 mm connector type: ≤ 15 %)			
Standard sensing target: iron	8 × 8 × 1 mm	12 × 12 × 1 mm	18 × 18 × 1 mm	30 × 30 × 1 mm
Response frequency ⁰¹⁾	1.5 kHz	1.5 kHz	500 Hz	400 Hz
Affection by temperature	≤ ± 10 % for sensing distance at ambient temperature 20 °C (DIA. of sensing side Ø 8 mm: ≤ ± 20 %)			
Indicator	Operation indicator (red)			
Approval	CE EAC	CE EAC	CE EAC	CE EAC
Installation	Non-flush type			
General	PR□08-2D □	PR□12-4D □	PR□18-8D □	PR□30-15D □
DIA. of sensing side	Ø 8 mm	Ø 12 mm	Ø 18 mm	Ø 30 mm
Sensing distance	2 mm	4 mm	8 mm	15 mm
Setting distance	0 to 1.4 mm	0 to 2.8 mm	0 to 5.6 mm	0 to 10.5 mm
Hysteresis	≤ 10 % of sensing distance (DIA. of sensing side Ø 8 mm connector type: ≤ 15 %)			
Standard sensing target: iron	8×8×1 mm	12×12×1 mm	25×25×1 mm	45×45×1 mm
Response frequency ⁰¹⁾	1.0 kHz	500 Hz	350 Hz	200 Hz
Affection by temperature	≤ ± 10 % for sensing distance at ambient temperature 20 °C (DIA. of sensing side Ø 8 mm: ≤ ± 20 %)			
Indicator	Operation indicator (red)			
Approval	CE EAC	CE EAC	CE EAC	CE EAC

01) The response frequency is the average value. The standard sensing target is used and the width is set as 2 times of the standard sensing target, 1/2 of the sensing distance for the distance.

Unit weight (package)		Ø 8 mm	Ø 12 mm	Ø 18 mm	Ø 30 mm
Cable	Normal	≈ 52 g (≈ 64 g)	≈ 72 g (≈ 84 g)	≈ 110 g (≈ 122 g)	≈ 170 g (≈ 207 g)
	Short	-	≈ 70 g (≈ 82 g)	-	-
	Long	≈ 54 g (≈ 66 g)	≈ 76 g (≈ 88 g)	≈ 130 g (≈ 142 g)	≈ 210 g (≈ 247 g)
Cable connector	Normal	≈ 32 g (≈ 44 g)	≈ 42 g (≈ 54 g)	≈ 58 g (≈ 70 g)	≈ 122 g (≈ 134 g)
	Long	≈ 34 g (≈ 46 g)	-	≈ 78 g (≈ 90 g)	≈ 158 g (≈ 195 g)
Connector	Normal	≈ 10 g (≈ 32 g)	≈ 26 g (≈ 38 g)	≈ 49 g (≈ 61 g)	≈ 134 g (≈ 146 g)
	Long	-	-	≈ 73 g (≈ 85 g)	≈ 169 g (≈ 181 g)

Power supply	12 - 24 VDC \pm (ripple P-P: \leq 10 %), operating voltage: 10 - 30 VDC \pm
Current consumption	\leq 10 mA
Control output	\leq 200 mA
Residual voltage	DIA. of sensing side \varnothing 8 mm: \leq 2.0 V DIA. of sensing side \varnothing 12 mm, \varnothing 18 mm, \varnothing 30 mm: \leq 1.5 V
Protection circuit	Surge protection circuit, output short over current protection circuit, reverse polarity protection
Insulation resistance	\geq 50 M Ω (500 VDC \pm megger)
Dielectric strength	1,500 VAC \sim 50 / 60Hz for 1 min (between all terminals and case)
Vibration	1 mm double amplitude at frequency 10 to 55 Hz (for 1 min) in each X, Y, Z direction for 2 hours
Shock	500 m/s ² (\approx 50 G) in each X, Y, Z direction for 3 times
Ambient temperature	-25 to 70 °C, storage: -30 to 80 °C (no freezing or condensation)
Ambient humidity	35 to 95 %RH, storage: 35 to 95 %RH (no freezing or condensation)
Protection structure	IP67 (IEC standards)
Connection	Cable type / Cable connector type ⁰¹⁾ / Connector type model
Cable spec. ⁰²⁾	DIA. of sensing side \varnothing 8 mm: \varnothing 3.5 mm, 3-wire DIA. of sensing side \varnothing 12 mm: \varnothing 4 mm, 3-wire DIA. of sensing side \varnothing 18 mm, \varnothing 30 mm: \varnothing 5 mm, 3-wire
Wire spec.	\varnothing 3.5 mm cable: AWG 24 (0.08 mm, 40-core), insulator DIA.: \varnothing 1 mm \varnothing 4 mm, \varnothing 5 mm cable : AWG 22 (0.08 mm, 60-core), insulator DIA.: \varnothing 1.25 mm
Connector spec.	M12 connector
Material	Standard type cable (black): polyvinyl chloride (PVC) Oil resistant cable (gray): polyvinyl chloride (oil resistant PVC)
General	Case/Nut: nickel plated brass (DIA. of sensing side \varnothing 8 mm connector type case: SUS303), washer: nickel plated iron, sensing side: PBT
Spatter-resistant	Case/Nut: PTFE coated brass, washer: PTFE coated iron, sensing side: PTFE

01) Except spatter-resistant type

02) Cable type: 2 m, cable connector type: 300 mm

Cylindrical Inductive Proximity Sensors

(DC 2-Wire)

PR Series



Features

- Spatter-resistant type:
PTFE coated for high heat resistance
(prevent malfunction from welding spatter)
- Operation indicator (red LED)
- IP67 Protection structure (IEC standards)

Specifications

Installation	Flush type			
General	PR□T08-1.5 □	PR□T12-2 □	PR□T18-5 □	PR□T30-10 □
Spatter-resistant	-	PRA□T12-2 □	PRA□T18-5 □	PRA□T30-10 □
DIA. of sensing side	Ø 8 mm	Ø 12 mm	Ø 18 mm	Ø 30 mm
Sensing distance	1.5 mm	2 mm	5 mm	10 mm
Setting distance	0 to 1.05 mm	0 to 1.4 mm	0 to 3.5 mm	0 to 7 mm
Hysteresis	≤ 10 % of sensing distance (DIA. of sensing side Ø 8 mm connector type: ≤ 15 %)			
Standard sensing target: iron	8 × 8 × 1 mm	12 × 12 × 1 mm	18 × 18 × 1 mm	30 × 30 × 1 mm
Response frequency ⁰¹⁾	1.5 kHz	1.5 kHz	500 Hz	400 Hz
Affection by temperature	≤ ± 10 % for sensing distance at ambient temperature 20 °C (DIA. of sensing side Ø 8 mm: ≤ ± 20 %)			
Indicator	Operation indicator (red)			
Approval	CE EAC	CE EAC	CE EAC	CE EAC
Installation	Non-flush type			
General	PR□T08-2 □	PR□T12-4 □	PR□T18-8 □	PR□T30-15 □
DIA. of sensing side	Ø 8 mm	Ø 12 mm	Ø 18 mm	Ø 30 mm
Sensing distance	2 mm	4 mm	8 mm	15 mm
Setting distance	0 to 1.4 mm	0 to 2.8 mm	0 to 5.6 mm	0 to 10.5 mm
Hysteresis	≤ 10 % of sensing distance (DIA. of sensing side Ø 8 mm connector type: ≤ 15 %)			
Standard sensing target: iron	8 × 8 × 1 mm	12 × 12 × 1 mm	25 × 25 × 1 mm	45 × 45 × 1 mm
Response frequency ⁰¹⁾	1.0 kHz	500 Hz	350 Hz	200 Hz
Affection by temperature	≤ ± 10 % for sensing distance at ambient temperature 20 °C (DIA. of sensing side Ø 8 mm: ≤ ± 20 %)			
Indicator	Operation indicator (red)			
Approval	CE EAC	CE EAC	CE EAC	CE EAC
Unit weight (package)	Ø 8 mm	Ø 12 mm	Ø 18 mm	Ø 30 mm
Cable	≈ 52 g (≈ 64 g)	≈ 72 g (≈ 84 g)	≈ 110 g (≈ 122 g)	≈ 170 g (≈ 207 g)
Cable connector	≈ 32 g (≈ 44 g)	≈ 42 g (≈ 54 g)	≈ 58 g (≈ 70 g)	≈ 122 g (≈ 134 g)
Connector	≈ 10 g (≈ 32 g)	≈ 26 g (≈ 38 g)	≈ 49 g (≈ 61 g)	≈ 142 g (≈ 154 g) ⁰¹⁾

01) The response frequency is the average value. The standard sensing target is used and the width is set as 2 times of the standard sensing target, 1/2 of the sensing distance for the distance.

01) Spatter-resistant type: ≈ 134 g (≈ 146 g)

Power supply	12 - 24 VDC \equiv (ripple P-P: \leq 10 %), operating voltage: 10 - 30 VDC \equiv
Leakage current	\leq 0.6 mA
Control output	2 to 100 mA
Residual voltage	\leq 3.5 V (non-polarity ⁰¹⁾ ; \leq 5 V)
Protection circuit	Surge protection circuit, output short over current protection circuit, reverse polarity protection
Insulation resistance	\geq 50 M Ω (500 VDC \equiv megger)
Dielectric strength	1,500 VAC \sim 50 / 60 Hz for 1 min (between all terminals and case)
Vibration	1 mm double amplitude at frequency 10 to 55 Hz (for 1 min) in each X, Y, Z direction for 2 hours
Shock	500 m/s ² (\approx 50 G) in each X, Y, Z direction for 3 times
Ambient temperature	-25 to 70 °C, storage: -30 to 80 °C (no freezing or condensation)
Ambient humidity	35 to 95 %RH, storage: 35 to 95 %RH (no freezing or condensation)
Protection structure	IP67 (IEC standards)
Connection	Cable type / Cable connector type / Connector type model
Cable spec. ⁰²⁾	DIA. of sensing side \varnothing 8 mm: \varnothing 3.5 mm, 2-wire DIA. of sensing side \varnothing 12 mm: \varnothing 4 mm, 2-wire DIA. of sensing side \varnothing 18 mm, \varnothing 30 mm: \varnothing 5 mm, 2-wire
Wire spec.	\varnothing 3.5 mm cable : AWG 24 (0.08 mm, 40-core), insulator diameter: \varnothing 1 mm \varnothing 4 mm, \varnothing 5 mm cable : AWG 22 (0.08 mm, 60-core), insulator diameter: \varnothing 1.25 mm
Connector spec.	M12 connector
Material	Standard type cable (black): polyvinyl chloride (PVC) Oil resistant cable type cable (gray): polyvinyl chloride (oil resistant PVC)
General	Case/Nut: nickel plated brass (DIA. of sensing side \varnothing 8 mm connector type case: SUS303), washer: nickel plated iron, sensing side: PBT
Spatter-resistant	Case/Nut: PTFE coated brass, washer: PTFE coated iron, sensing side: PTFE

01) Check the condition of connected device.

02) Cable type: 2 m, cable connector type: 300 mm

Cylindrical Inductive Proximity Sensors

(AC 2-Wire)

PR Series



Features

- Spatter-resistant type: PTFE coated for high heat resistance (prevent malfunction from welding spatter)
- Operation indicator (red LED)
- IP67 Protection structure (IEC standards)

Specifications

Installation	Flush type		
General	PR□12-2A□	PR□18-5A□	PR□30-10A□
Spatter-resistant	PRA□12-2A□	PRA□18-5A□	PRA□30-10A□
DIA. of sensing side	Ø 12 mm	Ø 18 mm	Ø 30 mm
Sensing distance	2 mm	5 mm	10 mm
Setting distance	0 to 1.4 mm	0 to 3.5 mm	0 to 7 mm
Hysteresis	≤ 10 % of sensing distance		
Standard sensing target: iron	12 × 12 × 1 mm	18 × 18 × 1 mm	30 × 30 × 1 mm
Response frequency ⁰¹⁾	20 Hz		
Affection by temperature	≤ ± 10 % for sensing distance at ambient temperature 20 °C		
Indicator	Operation indicator (red)		
Approval	CE ENEC	CE ENEC	CE ENEC

Installation	Non-flush type		
General	PR□12-4A □	PR□18-8A □	PR□30-15A □
DIA. of sensing side	Ø 12 mm	Ø 18 mm	Ø 30 mm
Sensing distance	4 mm	8 mm	15 mm
Setting distance	0 to 2.8 mm	0 to 5.6 mm	0 to 10.5 mm
Hysteresis	≤ 10 % of sensing distance		
Standard sensing target: iron	12 × 12 × 1 mm	25 × 25 × 1 mm	45 × 45 × 1 mm
Response frequency ⁰¹⁾	20 Hz		
Affection by temperature	≤ ± 10 % for sensing distance at ambient temperature 20 °C		
Indicator	Operation indicator (red)		
Approval	CE ENEC	CE ENEC	CE ENEC

01) The response frequency is the average value. The standard sensing target is used and the width is set as 2 times of the standard sensing target, 1/2 of the sensing distance for the distance.

Unit weight (package)		Ø 12 mm	Ø 18 mm	Ø 30 mm
Cable	Normal	≈ 72 g (≈ 84 g) ⁰¹⁾	≈ 118 g (≈ 130 g) ⁰²⁾	≈ 170 g (≈ 207 g)
	Long	-	≈ 130 g (≈ 142 g)	≈ 208 g (≈ 245 g)
Cable connector	Normal	≈ 42 g (≈ 54 g)	≈ 66 g (≈ 78 g)	≈ 122 g (≈ 134 g)
	Long	-	≈ 78 g (≈ 90 g)	≈ 158 g (≈ 195 g)
Connector	Normal	≈ 30 g (≈ 42 g)	≈ 54 g (≈ 66 g)	≈ 142 g (≈ 154 g)
	Long	-	≈ 66 g (≈ 78 g)	≈ 182 g (≈ 194 g)

01) Spatter-resistant type: ≈ 66 g (≈ 78 g)

02) Spatter-resistant type: ≈ 106 g (≈ 118 g)

Power supply	100 - 240 VAC~ 50 / 60 Hz, operating voltage: 85 - 264 VAC~
Leakage current	≤ 2.5 mA
Control output	DIA. of sensing side Ø 12 mm: 5 to 150 mA DIA. of sensing side Ø 18 mm, Ø 30 mm: 5 to 200 mA
Residual voltage	≤ 10 V
Protection circuit	Surge protection circuit
Insulation resistance	≥ 50 MΩ (500 VDC= megger)
Insulation type	Double insulation or reinforced insulation (symbol: ) dielectric strength between the measuring input part and the power part: general type 1 kV, spatter-resistant type 1.5 kV
Dielectric strength	General type : 2,500 VAC~ 50/60 Hz for 1 min (between all terminals and case) Spatter-resistant type : 1,500 VAC~ 50/60 Hz for 1 min (between all terminals and case)
Vibration	1 mm double amplitude at frequency 10 to 55 Hz (for 1 min) in each X, Y, Z direction for 2 hours
Shock	500 m/s ² (≈ 50 G) in each X, Y, Z direction for 3 times
Ambient temperature	-25 to 70 °C, storage: -30 to 80 °C (no freezing or condensation)
Ambient humidity	35 to 95 %RH, storage: 35 to 95 %RH (no freezing or condensation)
Protection structure	IP67 (IEC standards)
Connection	Cable type / Cable connector type ⁰¹⁾ / Connector type ⁰¹⁾ model
Cable spec. ⁰²⁾	DIA. of sensing side Ø 12 mm: Ø 4 mm, 2-wire DIA. of sensing side Ø 18 mm, Ø 30 mm: Ø 5 mm, 2-wire
Wire spec.	AWG 22 (0.08 mm, 60-core), insulator diameter: Ø 1.25 mm
Connector spec.	M12 connector
Material	Standard type cable (black): polyvinyl chloride (PVC)
General	Case/Nut: nickel plated brass, washer: nickel plated iron, sensing side: PBT
Spatter-resistant	Case/Nut: PTFE coated brass, washer: PTFE coated iron, sensing side: PTFE

01) Except spatter-resistant type

02) Cable type: 2 m, cable connector type: 300 mm

Cylindrical Inductive Full-Metal Long-Distance Proximity Sensors (DC 2-Wire)

PRFD Series



Features

- Long sensing distance
- High resistance to impact and wear caused by contact with workpieces or wire brushes (sensor head / housing : stainless steel)
- Reduced risk of malfunction caused by aluminum chips
- Spatter-resistant type: PTFE coating prevents malfunctions caused by welding spatter
- 360° ring type operation indicator (red LED) (except Ø 8 mm model)
- Oil resistant cable
- IP67 protection structure (IEC standards)

Specifications

Installation	Flush type			
General	PRFD□T08-2DO-□	PRFD□T12-3DO-□	PRFD□T18-7DO-□	PRFD□T30-12DO-□
Spatter-resistant	PRFDA□T08-2DO-□	PRFDA□T12-3DO-□	PRFDA□T18-7DO-□	PRFDA□T30-12DO-□
DIA. of sensing side	Ø 8 mm	Ø 12 mm	Ø 18 mm	Ø 30 mm
Sensing distance ⁰¹⁾	2 mm	3 mm	7 mm	12 mm
Setting distance	0 to 1.4 mm	0 to 2.1 mm	0 to 4.9 mm	0 to 8.4 mm
Hysteresis	≤ 15 % of sensing distance			
Standard sensing target: iron	12 × 12 × 1 mm	12 × 12 × 1 mm	30 × 30 × 1 mm	54 × 54 × 1 mm
Response frequency ⁰²⁾	150 Hz	80 Hz	80 Hz	50 Hz
Affection by temperature	≤ ± 20 % for sensing distance at ambient temperature 20 °C			
Indicator	Stability indicator (green), operation indicator (red)			
Approval	CE ERIC	CE ERIC	CE ERIC	CE ERIC
Unit weight (package)	≈ 55 g (≈ 80 g)	≈ 83 g (≈ 110 g)	≈ 97 g (≈ 132 g)	≈ 170 g (≈ 225 g)

01) Use accessories (nut, washer) made of SUS. Or, sensing distance cannot be guaranteed.

02) The response frequency is the average value. The standard sensing target is used and the width is set as 2 times of the standard sensing target, 1/2 of the sensing distance for the distance.

Power supply	12 - 24 VDC≐ (ripple P-P: ≤ 10 %), operating voltage: 10 - 30 VDC≐
Leakage current	≤ 0.8 mA
Control output	3 to 100 mA
Residual voltage	≤ 3.5 V
Protection circuit	Surge protection circuit, output short over current protection circuit, reverse polarity protection
Insulation resistance	≥ 50 MΩ (500 VDC≐ megger)
Dielectric strength	1,000 VAC~ 50 / 60Hz for 1 minute (between all terminals and case)
Vibration	1.5 mm double amplitude at frequency 10 to 55 Hz in each X, Y, Z direction for 2 hours
Shock	1,000 m/s ² (≈ 100 G) in each X, Y, Z direction for 10 times (DIA. of sensing side Ø 8 mm: : 500 m/s ² (≈ 50 G) in each X, Y, Z direction for 10 times)
Ambient temp. ⁰¹⁾	-25 to 70 °C, storage: -25 to 70 °C (no freezing or condensation)
Ambient humi.	35 to 95 %RH, storage: 35 to 95 %RH (no freezing or condensation)
Protection	IP67 (IEC standards)
Connection	Cable type / Cable connector type model
Cable spec. ⁰²⁾	DIA. of sensing side Ø 8 mm: Ø 4 mm, 2-wire DIA. of sensing side Ø 12 mm, Ø 18 mm, Ø 30 mm: Ø 5 mm, 2-wire
Wire spec.	AWG 22 (0.08 mm, 60-wire), insulator diameter: Ø 1.25 mm
Connector	M12 connector
Material	Oil resistant cable (dark gray): oil resistant polyvinyl chloride (PVC)
General	Case / Nut: stainless steel 303 (SUS303), washer: stainless steel 304 (SUS304), sensing side ⁰³⁾ : stainless steel 303 (SUS303)
Spatter-resistant	Case / Nut: stainless steel 303 (SUS303, PTFE coated), washer: stainless steel 304 (SUS304), sensing side ⁰³⁾ : stainless steel 303 (SUS303, PTFE coated)

01) UL approved surrounding air temperature 40 °C

02) Cable type: 2 m (option: 5 m), cable connector type: 300 mm

03) Thickness: DIA. of sensing side Ø 8 mm: 0.2 mm / DIA. of sensing side Ø 12 mm, Ø 18 mm: 0.4 mm / DIA. of sensing side Ø 30 mm: 0.5 mm

Cylindrical Inductive Full-Metal Proximity Sensors

(DC 2-Wire)

PRF Series

Features

- High resistance to impact and wear caused by contact with workpieces or wire brushes (sensor head / housing: stainless steel)
- Reduced risk of malfunction caused by aluminum chips
- Spatter-resistant type: PTFE coating prevents malfunctions caused by welding spatter
- 360° ring type operation indicator (red LED) (except Ø 8 mm model)
- Oil resistant cable
- IP67 protection structure (IEC standards)



Specifications

Installation	Flush type			
General	PRF□T08-1.5DO-□	PRF□T12-2DO-□	PRF□T18-5DO-□	PRF□T30-10DO-□
Spatter-resistant	PRFA□T08-1.5DO-□	PRFA□T12-2DO-□	PRFA□T18-5DO-□	PRFA□T30-10DO-□
DIA. of sensing side	Ø 8 mm	Ø 12 mm	Ø 18 mm	Ø 30 mm
Sensing distance ⁰¹⁾	1.5 mm	2 mm	5 mm	10 mm
Setting distance	0 to 1.05 mm	0 to 1.4 mm	0 to 3.5 mm	0 to 7 mm
Hysteresis	≤ 15 % of sensing distance			
Standard sensing target: iron	8 × 8 × 1 mm	12 × 12 × 1 mm	30 × 30 × 1 mm	54 × 54 × 1 mm
Response frequency ⁰²⁾	200 Hz	100 Hz	80 Hz	50 Hz
Affection by temperature	± 20 % for sensing distance at ambient temperature 20 °C			
Indicator	Operating indicator (red)			
Approval	CE ENEC	CE ENEC	CE ENEC	CE ENEC
Unit weight (package)	≈ 55 g (≈ 80 g)	≈ 83 g (≈ 110 g)	≈ 97 g (≈ 132 g)	≈ 170 g (≈ 225 g)

01) Use accessories (nut, washer) made of SUS. Or, sensing distance cannot be guaranteed.

02) The response frequency is the average value. The standard sensing target is used and the width is set as 2 times of the standard sensing target, 1/2 of the sensing distance for the distance.

Power supply	12 - 24 VDC≡ (ripple P-P: ≤ 10 %), operating voltage: 10 - 30 VDC≡
Leakage current	≤ 0.8 mA
Control output	3 to 100 mA
Residual voltage	≤ 3.5 V
Protection circuit	Surge protection circuit, output short over current protection circuit, reverse polarity protection
Insulation resistance	≥ 50 MΩ (500 VDC≡ megger)
Dielectric strength	1,000 VAC~ 50/60Hz for 1 minute (between all terminals and case)
Vibration	1.5 mm amplitude at frequency 10 to 55 Hz in each X, Y, Z direction for 2 hours
Shock	1,000 m/s ² (≈ 100 G) in each X, Y, Z direction for 10 times (DIA. of sensing side Ø 8 mm) : 500 m/s ² (≈ 50 G) in each X, Y, Z direction for 10 times
Ambient temp. ⁰¹⁾	-25 to 70 °C, storage: -25 to 70 °C (non-freezing or non-condensation)
Ambient humi.	35 to 95 %RH, storage: 35 to 95 %RH (non-freezing or non-condensation)
Protection	IP67 (IEC standards)
Connection	Cable type / Cable connector type model
Cable spec. ⁰²⁾	DIA. of sensing side Ø 8 mm: Ø 4 mm, 2-wire DIA. of sensing side Ø 12 mm, Ø 18 mm, Ø 30 mm: Ø 5 mm, 2-wire
Wire spec.	AWG 22 (0.08 mm, 60-wire), insulator diameter: Ø 1.25 mm
Connector	M12 connector
Material	Oil resistant cable (dark gray): oil resistant polyvinyl chloride (PVC)
General	Case/Nut: SUS303, washer: SUS304, sensing side ⁰³⁾ : SUS303
Spatter-resistant	Case/Nut: SUS303 (PTFE coated), washer: SUS304, sensing side ⁰³⁾ : SUS303 (PTFE coated)

01) UL approved surrounding air temperature 40 °C

02) Cable type: 2 m (option: 5 m), cable connector type: 300 mm

03) Thickness: 0.8 mm (DIA. of sensing side Ø 8 mm: 0.4 mm)

Cylindrical Inductive Transmission Couplers

PET Series



Features

- Inductive coupling allows signals to be generated and transmitted without additional power supply
- Stable operation in various environmental settings including dust or oil
- Applications: drilling, robotics, automated conveyors system, etc.

Specifications

Installation	Flush type
Model	PET18-5
Transmitting distance	5 mm
Setting distance	1 to 4.5 mm
Response time	≤ 1 ms
Indicator	Operation indicator (red)
Approval	CE
Unit weight (package)	≈ 121 g (≈ 133 g)
Insulation type	≥ 50 MΩ (500 VDC≡ megger)
Dielectric strength	1,500 VAC~ 50 / 60 Hz for 1 min
Vibration	1 mm double amplitude at frequency 10 to 55 Hz (for 1 min) in each X, Y, Z direction for 2 hours
Shock	500 m/s ² (≈ 50 G) X, Y, Z directions for 3 times
Ambient temperature	-25 to 70 °C, storage: -30 to 80 °C (no freezing or condensation)
Ambient humidity	35 to 95 %RH, storage: 35 to 95 %RH (no freezing or condensation)
Protection structure	IP67 (IEC standards)
Connection	Cable type model
Wire spec.	Ø 5 mm, 2-wire, 2 m
Connector spec.	AWG 22 (0.08 mm, 60-core), insulator diameter: Ø 1.25 mm
Contact switch spec.	Contact resistance is ≤ 300 mΩ, open resistance is ≥ 10 MΩ, leakage current at OFF is zero.
Material	Nut/Case: nickel plated brass, washer: nickel plated steel, sensing side: PBT, Standard type cable (black): polyvinyl chloride (PVC)

Rectangular Inductive Proximity Sensors

(DC 3-Wire,
□ 8 / 12 / 50 mm)

PS Series



Features

- Alternate frequency models allow adjacent installation of multiple sensors without interference (PSN17-□-F model)
- Operation indicator (red LED)
- IP67 protection structure (IEC standard)

Specifications

Installation	Standard type / Upper side type		
Model	PS08-2.5D□-□	PS12-4D□-□	PS50-30D□
Sensing side length	8 mm	12 mm	50 mm
Sensing distance	2.5 mm	4 mm	30 mm
Setting distance	0 to 1.75 mm	0 to 2.8 mm	0 to 21 mm
Hysteresis	≤ 10 % of sensing distance (sensing side length 8 mm: ≤ 20 %)		
Standard sensing target: iron	8 × 8 × 1 mm	12 × 12 × 1 mm	90 × 90 × 1 mm
Response frequency ⁰¹⁾	1 kHz	500 Hz	50 Hz
Affection by temperature	≤ ± 10 % for sensing distance at ambient temperature 20 °C (sensing side length 8 mm: ≤ ± 15 %)		
Indicator	Operating indicator (red)		
Approval	CE EAC	CE EAC	CE EAC
Unit weight (package)	≈ 16 g (≈ 30 g)	≈ 62 g (≈ 77 g)	≈ 220 g (≈ 256 g)

⁰¹⁾ The response frequency is the average value. The standard sensing target is used and the width is set as 2 times of the standard sensing target, 1/2 of the sensing distance for the distance.

Power supply	12 - 24 VDC≐ (ripple P-P: ≤ 10 %), operating voltage: 10 - 30 VDC≐
Current consumption	≤ 10 mA
Control output	Sensing side length 8 mm: ≤ 100 mA Sensing side length 12 mm, 50 mm: ≤ 200 mA
Residual voltage	Sensing side length 8 mm: ≤ 1.0 V Sensing side length 12 mm, 50 mm: ≤ 1.5 V
Protection circuit	Surge protection circuit, output short over current protection circuit, reverse polarity protection
Insulation resistance	≥ 50 MΩ (500 VDC≐ megger)
Dielectric strength	Between all terminals and case: 1,500 VAC~ 50 / 60Hz for 1 minute (sensing side length 8 mm - between all terminals and case: 1,000 VAC~ 50 / 60Hz for 1 minute
Vibration	1 mm double amplitude at frequency 10 to 55 Hz in each of X, Y, Z directions for 2 hours
Shock	500 m/s ² (≈ 50 G) X, Y, Z directions for 3 times
Ambient temp.	-25 to 70 %RH, storage: -30 to 80 %RH (no freezing or condensation)
Ambient humi.	35 to 95 %RH, storage: 35 to 95 %RH (no freezing or condensation)
Protection rating	IP67 (IEC standards)
Connection	Cable type
Cable spec.	Sensing side length 8 mm: Ø 2.5 mm, 3-wire, 1 m Sensing side length 12 mm: Ø 4 mm, 3-wire, 2 m Sensing side length 50 mm: Ø 5 mm, 3-wire, 2 m
Wire spec.	Ø 2.5 mm cable : AWG 28 (0.08 mm, 19-core), insulator diameter: Ø 0.9 mm Ø 4 mm, Ø 5 mm cable : AWG 22 (0.08 mm, 60-core), insulator diameter: Ø 1.25 mm
Material	Sensing side length 8 mm Case: PC, Sensing side length 12 mm Case: Heat-resistant ABS, Sensing side length 50 mm Case: PBT, standard cable (black): polyvinyl chloride (PVC)

Rectangular Inductive Proximity Sensors

(DC 3-Wire,

□ 17 / 25 / 30 / 40 mm)

PS Series



Features

- Alternate frequency models allow adjacent installation of multiple sensors without interference (PSN17-□-F model)
- Operation indicator (red LED)
- IP67 protection structure (IEC standard)

Specifications

Installation	Standard type / Upper side type		Standard type			
	PSN17-5D□□-□	PSN17-8D□□-□	PSN25-5D□	PSN30-10D□	PSN30-15D□	PSN40-20D□
Model						
Sensing side length	18 mm	18 mm	25 mm	30 mm	30 mm	40 mm
Sensing distance	5 mm	8 mm	5 mm	10 mm	15 mm	20 mm
Setting distance	0 to 3.5 mm	0 to 5 mm	0 to 3.5 mm	0 to 7 mm	0 to 10.5 mm	0 to 14 mm
Hysteresis	≤ 10 % of sensing distance					
Standard sensing target: iron	18 × 18 × 1 mm	25 × 25 × 1 mm	25 × 25 × 1 mm	30 × 30 × 1 mm	45 × 45 × 1 mm	60 × 60 × 1 mm
Response frequency ⁰¹⁾	700 Hz	200 Hz	300 Hz	250 Hz	200 Hz	100 Hz
Affection by temperature	± 10 % for sensing distance at ambient temperature 20 °C					
Indicator	Operation indicator (red)					
Approval	CE EAC	CE EAC	CE EAC	CE EAC	CE EAC	CE EAC
Unit weight (package)	≈ 62 g (≈ 83 g)	≈ 62 g (≈ 83 g)	≈ 71 g (≈ 103 g)	≈ 96 g (≈ 165 g)	≈ 96 g (≈ 165 g)	≈ 135 g (≈ 225 g)

01) The response frequency is the average value. The standard sensing target is used and the width is set as 2 times of the standard sensing target, 1/2 of the sensing distance for the distance.

Power supply	12 - 24 VDC≡ (ripple P-P: ≤ 10 %), operating voltage: 10 - 30 VDC≡
Current consumption	≤ 10 mA
Control output	≤ 200 mA
Residual voltage	≤ 1.5 V
Protection circuit	Surge protection circuit, output short over current protection circuit, reverse polarity protection
Insulation type	≥ 50 MΩ (500 VDC≡ megger)
Dielectric strength	1,500 VAC~ 50/60 Hz for 1 min (between all terminals and case)
Vibration	1 mm double amplitude at frequency 10 to 55 Hz (for 1 min) in each X, Y, Z direction for 2 hours
Shock	500 m/s ² (≈ 50 G) in each X, Y, Z direction for 3 times
Ambient temp.	-25 to 70 °C, storage: -30 to 80 °C (no freezing or condensation)
Ambient humi.	35 to 95 %RH, storage: 35 to 95 %RH (no freezing or condensation)
Protection structure	IP67 (IEC standard)
Connection	Cable type model
Wire spec.	∅ 4 mm, 3-wire, 2 m
Connector spec.	AWG 22 (0.08 mm, 60-core), insulator diameter: ∅ 1.25 mm
Material	Case: Heat-resistant ABS, standard type cable (black): polyvinyl chloride (PVC)

Rectangular Inductive Proximity Sensors

(DC 2-Wire)

PS Series



Features

- Operation indicator (red LED)
- IP67 protection structure (IEC standard)

Specifications

Installation	Standard type / Upper side type
Model	PSNT17-5D□□
Sensing side length	18 mm
Sensing distance	5 mm
Setting distance	0 to 3.5 mm
Hysteresis	≤ 10 % of sensing distance
Standard sensing target: iron	18 × 18 × 1 mm
Response frequency ⁰¹⁾	700 Hz
Affection by temperature	± 10 % for sensing distance at ambient temperature 20 °C
Indicator	Operation indicator (red)
Approval	CE ENEC
Unit weight (package)	≈ 58 g (≈ 79 g)

01) The response frequency is the average value. The standard sensing target is used and the width is set as 2 times of the standard sensing target, 1/2 of the sensing distance for the distance.

Power supply	12 - 24 VDC≐ (ripple P-P: ≤ 10 %), operating voltage: 10 - 30 VDC≐
Leakage current	≤ 0.6 mA
Control output	2 to 100 mA
Residual voltage	≤ 3.5 V
Protection circuit	Surge protection circuit, output short over current protection circuit, reverse polarity protection
Insulation type	≥ 50 MΩ (500 VDC≐ megger)
Dielectric strength	1,500 VAC~ 50 / 60 Hz for 1 min (between all terminals and case)
Vibration	1 mm double amplitude at frequency 10 to 55 Hz (for 1 min) in each X, Y, Z direction for 2 hours
Shock	500 m/s ² (≈ 50 G) in each X, Y, Z direction for 3 times
Ambient temperature	-25 to 70 °C, storage: -30 to 80 °C (no freezing or condensation)
Ambient humidity	35 to 95 %RH, storage: 35 to 95 %RH (no freezing or condensation)
Protection structure	IP67 (IEC standards)
Connection	Cable type model
Wire spec.	Ø 4 mm, 2-wire, 2 m
Connector spec.	AWG 22 (0.08 mm, 60-core), insulator diameter: Ø 1.25 mm
Material	Case: PBT, standard type cable (black): polyvinyl chloride (PVC)

Rectangular Inductive Proximity Sensors

(AC 2-Wire)

PS Series

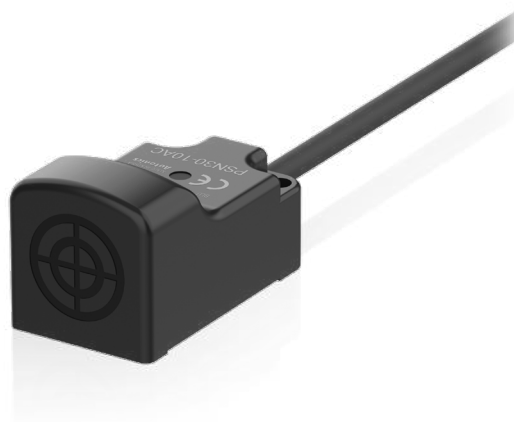

Features

- Operation indicator (red LED)
- IP67 protection structure (IEC standard)

Specifications

Installation	Standard type			
Model	PSN25-5A□	PSN30-10A□	PSN30-15A□	PSN40-20A□
Sensing side length	25 mm	30 mm	30 mm	40 mm
Sensing distance	5 mm	10 mm	15 mm	20 mm
Setting distance	0 to 3.5 mm	0 to 7 mm	0 to 10.5 mm	0 to 14 mm
Hysteresis	≤ 10 % of sensing distance			
Standard sensing target: iron	25 × 25 × 1 mm	30 × 30 × 1 mm	45 × 45 × 1 mm	60 × 60 × 1 mm
Response frequency ⁰¹⁾	20 Hz			
Affection by temperature	± 10 % for sensing distance at ambient temperature 20 °C			
Indicator	Operation indicator (red)			
Approval	CE EAC	CE EAC	CE EAC	CE EAC
Unit weight (package)	≈ 66 g (≈ 98 g)	≈ 92 g (≈ 161 g)	≈ 92 g (≈ 161 g)	≈ 130 g (≈ 219 g)

01) The response frequency is the average value. The standard sensing target is used and the width is set as 2 times of the standard sensing target, 1/2 of the sensing distance for the distance.

Power supply	100 - 240 VAC ~ 50 / 60 Hz, operating voltage: 85 - 264 VAC ~
Leakage current	≤ 2.5 mA
Control output	5 to 200 mA
Residual voltage	≤ 10 V
Protection circuit	Surge protection circuit
Insulation type	≥ 50 MΩ (500 VDC = megger)
Dielectric strength	Between all terminals and case: 1,500 VAC ~ 50/60 Hz for 1 min
Vibration	1 mm double amplitude at frequency 10 to 55 Hz (for 1 min) in each X, Y, Z direction for 2 hours
Shock	500 m/s ² (≈ 50 G) in each X, Y, Z direction for 3 times
Ambient temperature	-25 to 70 °C, storage: -30 to 80 °C (no freezing or condensation)
Ambient humidity	35 to 95 %RH, storage: 35 to 95 %RH (no freezing or condensation)
Protection rating	IP67 (IEC standards)
Connection	Cable type model
Wire spec.	Ø 4 mm, 2-wire, 2 m
Connector spec.	AWG 22 (0.08 mm, 60-core), insulator diameter: Ø 1.25 mm
Material	Case: Heat-resistant ABS, standard type cable (black): polyvinyl chloride (PVC)

Rectangular Inductive Long-Distance Proximity Sensors (DC 4-Wire)

AS Series



Features

- Long sensing distance 50 mm
- Power supply: 12 - 48 VDC \equiv
(operating voltage : 10 - 65 VDC \equiv)
- Simultaneous output
(Normally Open + Normally Closed)
- Power indicator (green LED) and
operation indicator (red LED)
- IP67 protection structure (IEC standard)

Specifications

Installation	Upper side type
Model	AS80-50D□
Sensing side length	80 mm
Sensing distance	50 mm
Setting distance	0 to 35 mm
Hysteresis	≤ 15 % of sensing distance
Standard sensing target: iron	150 × 150 × 1 mm
Response frequency ⁰¹⁾	30 Hz
Affection by temperature	± 10 % for sensing distance at ambient temperature 20 °C
Indicator	Power indicator (green), operation indicator (yellow)
Approval	CE ENEC
Unit weight	≈ 470 g
<small>01) The response frequency is the average value. The standard sensing target is used and the width is set as 2 times of the standard sensing target, 1/2 of the sensing distance for the distance.</small>	
Power supply	12 - 48 VDC \equiv (ripple P-P: ≤ 10 %), operating voltage: 10 - 65 VDC \equiv
Current consumption	≤ 20 mA
Control output	≤ 200 mA
Residual voltage	≤ 2 V
Protection circuit	Surge protection circuit, output short over current protection circuit, reverse polarity protection
Insulation type	≥ 50 MΩ (500 VDC \equiv megger)
Dielectric strength	1,500 VAC~ 50/60 Hz for 1 minute
Vibration	1 mm double amplitude at frequency 10 to 55 Hz (for 1 min) in each X, Y, Z direction for 2 hours
Shock	500 m/s ² (≈ 50 G) X, Y, Z directions for 3 times
Ambient temperature	-25 to 70 °C, storage: -30 to 80 °C (no freezing or condensation)
Ambient humidity	35 to 95 %RH, storage: 35 to 95 %RH (no freezing or condensation)
Protection structure	IP67 (IEC standard)
Connection	Cable type model
Wire spec.	Ø 5 mm, 4-wire, 2 m
Connector spec.	AWG 22 (0.08 mm, 60-core), insulator diameter: Ø 1.25 mm
Material	Case: PC+ABS, standard type cable (black): polyvinyl chloride (PVC)

Rectangular Flat-Type Inductive Proximity Sensors

(DC 3-Wire)

PFI Series

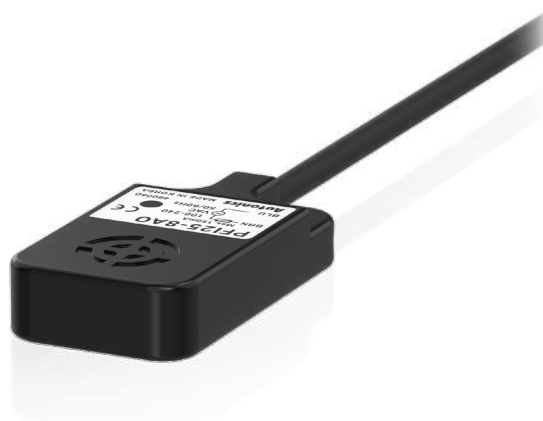

Features

- Flat, compact design (10 mm height) allows easy installation in limited spaces
- Operation indicator (red LED)
- IP67 protection structure (IEC standard)

Specifications

Installation	Upper side type
Model	PFI25-8D□
Sensing side length	25 mm
Sensing distance	8 mm
Setting distance	0 to 5.6 mm
Hysteresis	≤ 10 % of sensing distance
Standard sensing target: iron	25 × 25 × 1 mm
Response frequency ⁰¹⁾	200 Hz
Affection by temperature	≤ ± 10 % for sensing distance at ambient temperature 20 °C
Indicator	Operation indicator (red)
Approval	CE EAC
Unit weight	≈ 70 g
01) The response frequency is the average value. The standard sensing target is used and the width is set as 2 times of the standard sensing target, 1/2 of the sensing distance for the distance.	
Power supply	12 - 24 VDC≐ (ripple P-P: ≤ 10 %), operating voltage: 10 - 30 VDC≐
Current consumption	≤ 10 mA
Control output	≤ 200 mA
Residual voltage	≤ 1.5 V
Protection circuit	Surge protection circuit, output short over current protection circuit, reverse polarity protection
Insulation type	≥ 50 MΩ (500 VDC≐ megger)
Dielectric strength	1,500 VAC~ 50 / 60 Hz for 1 min
Vibration	1 mm double amplitude at frequency 10 to 55 Hz (for 1 min) in each X, Y, Z direction for 2 hours
Shock	500 m/s ² (≈ 50 G) in each X, Y, Z direction for 3 times
Ambient temperature	-25 to 70 °C, storage: -30 to 80 °C (no freezing or condensation)
Ambient humidity	35 to 95 %RH, storage: 35 to 95 %RH (no freezing or condensation)
Protection structure	IP67 (IEC standards)
Connection	Cable type model
Wire spec.	Ø 4 mm, 3-wire, 2 m
Connector spec.	AWG 22 (0.08 mm, 60-core), insulator diameter: Ø 1.25 mm
Material	Case: PPS, standard type cable (black): polyvinyl chloride (PVC)

Rectangular Flat-Type Inductive Proximity Sensors

(AC 2-Wire)

PFI Series

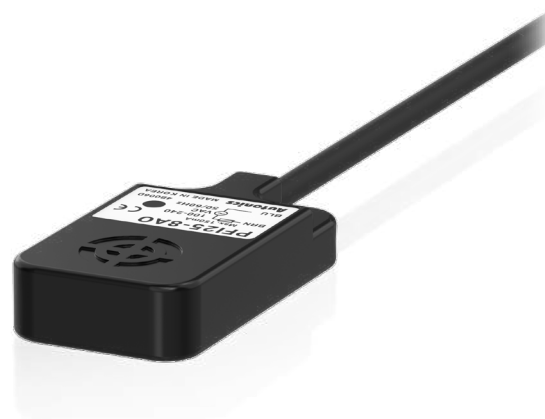

Features

- Flat, compact design (10 mm height) allows easy installation in limited spaces
- Operation indicator (red LED)
- IP67 protection structure (IEC standard)

Specifications

Installation	Upper side type
Model	PFI25-8A□
Sensing side length	25 mm
Sensing distance	8 mm
Setting distance	0 to 5.6 mm
Hysteresis	≤ 10 % of sensing distance
Standard sensing target: iron	25 × 25 × 1 mm
Response frequency ⁰¹⁾	20 Hz
Affection by temperature	≤ ± 10 % for sensing distance at ambient temperature 20 °C
Indicator	Operation indicator (red)
Approval	CE ENEC
Unit weight	≈ 70 g
<small>01) The response frequency is the average value. The standard sensing target is used and the width is set as 2 times of the standard sensing target, 1/2 of the sensing distance for the distance.</small>	
Power supply	100 - 240 VAC~ 50 / 60 Hz, operating voltage: 85 - 264 VAC~
Leakage current	≤ 2.5 mA
Control output	5 to 150 mA
Residual voltage	≤ 10 V
Protection circuit	Surge protection circuit
Insulation type	≥ 50 MΩ (500 VDC= megger)
Dielectric strength	1,500 VAC~ 50/60 Hz for 1 min
Vibration	1 mm double amplitude at frequency 10 to 55 Hz (for 1 min) in each X, Y, Z direction for 2 hours
Shock	500 m/s ² (≈ 50 G) in each X, Y, Z direction for 3 times
Ambient temperature	-25 to 70 °C, storage: -30 to 80 °C (no freezing or condensation)
Ambient humidity	35 to 95 %RH, storage: 35 to 95 %RH (no freezing or condensation)
Protection structure	IP67 (IEC standards)
Connection	Cable type model
Wire spec.	Ø 4 mm, 2-wire, 2 m
Connector spec.	AWG 22 (0.08 mm, 60-core), insulator diameter: Ø 1.25 mm
Material	Case: PPS, standard type cable (black): polyvinyl chloride (PVC)

Cylindrical Capacitive Proximity Sensors

(DC 3-Wire)

CR Series



Features

- Detect various materials including metal, iron, stone, plastic, water, and grain
- Built-in sensitivity adjuster for convenient configuration
- Operation indicator (red)
- Ideal for level detection and position control

Specifications

Installation	Non-flush type	
Model	CR18-8D□	CR30-15D□
DIA. of sensing side	Ø 18 mm	Ø 30 mm
Sensing distance	8 mm	15 mm
Setting distance	0 to 5.6 mm	0 to 10.5 mm
Hysteresis	≤ 20 % of sensing distance	
Standard sensing target: iron	50 × 50 × 1 mm	
Response frequency ⁰¹⁾	50 Hz	
Affection by temperature	± 20 % for sensing distance at ambient temperature 20 °C	
Indicator	Operation indicator (red)	
Approval	ERC	ERC
Unit weight (package)	≈ 76 g (≈ 88 g)	≈ 206 g (≈ 243 g)
<small>01) The response frequency is the average value. The standard sensing target is used and the width is set as 2 times of the standard sensing target, 1/2 of the sensing distance for the distance.</small>		
Power supply	12 - 24 VDC≐ (ripple P-P: ≤ 10 %), operating voltage: 10 - 30 VDC≐	
Current consumption	≤ 15 mA	
Control output	≤ 200 mA	
Residual voltage	≤ 1.5 V	
Protection circuit	Surge protection circuit, reverse polarity protection	
Insulation resistance	≥ 50 MΩ (500 VDC≐ megger)	
Dielectric strength	1,500 VAC~ 50 / 60Hz for 1 min (between all terminals and case)	
Vibration	1 mm double amplitude at frequency 10 to 55 Hz (for 1 min) in each X, Y, Z direction for 2 hours	
Shock	500 m/s ² (≈ 50 G) in each X, Y, Z direction for 3 times	
Ambient temperature	-25 to 70 °C, storage: -30 to 80 °C (no freezing or condensation)	
Ambient humidity	35 to 95 %RH, storage: 35 to 95 %RH (no freezing or condensation)	
Protection structure	DIA. of sensing side Ø 18 mm: IP66 (IEC standard) / DIA. of sensing side Ø 30 mm: IP65 (IEC standard)	
Connection	Cable type	
Cable spec.	DIA. of sensing side Ø 18 mm: Ø 4 mm, 3-wire, 2 m DIA. of sensing side Ø 30 mm: Ø 5 mm, 3-wire, 2 m	
Wire spec.	AWG 22 (0.08 mm, 60-core), insulator DIA.: Ø 1.25 mm	
Material	Standard type cable (black): polyvinyl chloride (PVC)	
DIA. of sensing side Ø 18 mm	Case / Nut: PA6	
DIA. of sensing side Ø 30 mm	Case / Nut: nickel-plated brass, washer: nickel-plated iron, sensing side: PBT	

Cylindrical Capacitive Proximity Sensors

(AC 2-Wire)

CR Series



Features

- Detect various materials including metal, iron, stone, plastic, water, and grain
- Built-in sensitivity adjuster for convenient configuration
- Operation indicator (red)
- Ideal for level detection and position control

Specifications

Installation	Non-flush type	
Model	CR18-8A□	CR30-15A□
DIA. of sensing side	Ø 18 mm	Ø 30 mm
Sensing distance	8 mm	15 mm
Setting distance	0 to 5.6 mm	0 to 10.5 mm
Hysteresis	≤ 20 % of sensing distance	
Standard sensing target: iron	50 × 50 × 1 mm	
Response frequency ⁰¹⁾	20 Hz	
Affection by temperature	≤ ± 20 % for sensing distance at ambient temperature 20 °C	
Indicator	Operation indicator (red)	
Approval	ERC	ERC
Unit weight (package)	≈ 70 g (≈ 82 g)	≈ 200 g (≈ 237 g)
01) The response frequency is the average value. The standard sensing target is used and the width is set as 2 times of the standard sensing target, 1/2 of the sensing distance for the distance.		
Power supply	100 -240 VAC~ / 50 / 60 Hz, operating voltage: 85 - 264 VAC~	
Leakage current	≤ 2.2 mA	
Control output	≤ 5 to 200 mA	
Residual voltage	≤ 20 V	
Protection circuit	Surge protection circuit	
Insulation resistance	≥ 50 MΩ (500 VDC= megger)	
Dielectric strength	1,500 VAC~ / 50 / 60Hz for 1 min (between all terminals and case)	
Vibration	1 mm double amplitude at frequency 10 to 55 Hz (for 1 min) in each X, Y, Z direction for 2 hours	
Shock	500 m/s ² (≈ 50 G) in each X, Y, Z direction for 3 times	
Ambient temperature	-25 to 70 °C, storage: -30 to 80 °C (no freezing or condensation)	
Ambient humidity	35 to 95 %RH, storage: 35 to 95 %RH (no freezing or condensation)	
Protection structure	DIA. of sensing side Ø 18 mm: IP66 (IEC standard) / DIA. of sensing side Ø 30 mm: IP65 (IEC standard)	
Connection	Cable type	
Cable spec.	DIA. of sensing side Ø 18 mm: Ø 4 mm, 2-wire, 2 m DIA. of sensing side Ø 30 mm: Ø 5 mm, 2-wire, 2 m	
Wire spec.	AWG 22 (0.08 mm, 60-core), insulator DIA.: Ø 1.25 mm	
Material	Standard type cable (black): polyvinyl chloride (PVC)	
DIA. of sensing side Ø 18 mm	Case / Nut: PA6	
DIA. of sensing side Ø 30 mm	Case / Nut: nickel-plated brass, washer: nickel-plated iron, sensing side: PBT	

U-Shaped Magnetic Proximity Sensors

MU Series

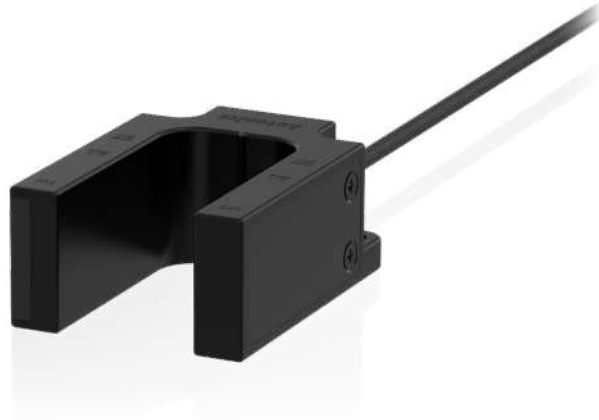

Features

- Non-voltage magnetic detection method
- Two wiring specifications of cable / cable connector type
- IP67 protection structure (IEC standard)

Specifications

Model	MU-1A-30-□	MU-1B-30-□
Contact	N.O.	N.C.
Operating distance ⁰¹⁾	OFF → ON	± 10 mm
	ON → OFF	± 20 mm
Standard sensing target	Steel plate - a galvanized steel sheet 1.6t	
Operating time	≤ 2 ms	
Release time	≤ 1 ms	
Operating frequency	≤ 500 Hz	
Approval	CE	
Unit weight (package)	Cable type: ≈ 132.5 g (= 172.3 g) Cable connector type: ≈ 107 g (= 147.2 g)	

01) Rated at the ambient temperature of 23 °C. It can be differed up to ±20 % according to the ambient temperature.

Switching voltage	≤ 24 VDC=
Life expectancy	≥ 100 million times (at a resistive load of 5 VDC= 10 mA)
Insulated resistance	≥ 1,000 MΩ (500 VDC= megger)
Dielectric strength	500 VAC~ 50/60 Hz for 1 minute (between all terminals and case)
Vibration	1.5 mm double amplitude at frequency of 10 to 55 Hz (for 1 minute) in each X, Y, Z direction for 2 hours
Shock	100 m/s ² (≈ 10 G) in each X, Y, Z direction for 3 times
Ambient temperature	-10 to 65 °C, storage: -10 to 70 °C (no freezing or condensation)
Ambient humidity	35 to 85 %RH, storage : 35 to 85 %RH (no freezing or condensation)
Protection structure	IP67 (IEC standard)
Connection	Cable type / Cable connector type
Cable	Cable type: Ø 4, 2-wire, 2 m (UL Style 20276, AWG22) Cable connector type: Ø 4, 2-wire, 0.5 m (UL Style 20276, AWG22)
Material	Cover/Case: PC (915R)

[Applied REED SWITCH]

Model	ORD324-10-15 (STANDEX MEDER)
Contact	A (SPST-NO: single pole, single throw, normally open)
Contact rating ⁰¹⁾	≤ 10 W/VA
Voltage	Switching: ≤ 200 VDC=, Breakdown: ≥ 250 VDC=
Current	Switching: ≤ 0.5 A, Carry: ≤ 1.0 A
Ambient temperature	-40 to 125 °C, storage : -65 to 125 °C ⁰²⁾
Material	Body: glass, leads: tin-plated Ni-Fe wire

01) Switching voltage and current should never exceed the wattage rating.

02) Long time exposure at elevated temperature may degrade solderability of the leads.



A9. Rotary Encoders

Rotary encoders are used to electronically monitor the position of a rotating shaft by converting shaft rotation into electronic pulses.

A

A9-1	Incremental	E15 Series	15 mm Diameter Incremental Rotary Encoders
		E18 Series	18 mm Diameter Incremental Rotary Encoders
		E20 Series	20 mm Diameter Incremental Rotary Encoders
		E30 Series	30 mm Diameter Incremental Rotary Encoders
		E40 Series	40 mm Diameter Incremental Rotary Encoders
		E50 Series	50 mm Diameter Incremental Rotary Encoders
		E58 Series	58 mm Diameter Incremental Rotary Encoders
		E60 Series	60 mm Diameter Incremental Rotary Encoders
		E68 Series	68 mm Diameter Incremental Rotary Encoders
		E80 Series	80 mm Diameter Incremental Rotary Encoders
		E88 Series	88 mm Diameter Incremental Rotary Encoders
		E100 Series	100 mm Diameter Incremental Rotary Encoders
		ENA Series	Side Mount Type Incremental Rotary Encoders
ENC Series	Wheel Type Incremental Rotary Encoders		
A9-2	Incremental (Sine Wave)	E18-A Series	18 mm Diameter Sine Wave Incremental Rotary Encoders
		E58-A Series	58 mm Diameter Sine Wave Incremental Rotary Encoders
		E60-A Series	60 mm Diameter Sine Wave Incremental Rotary Encoders
A9-3	Absolute (Single-Turn)	EP50 Series	50 mm Diameter Absolute Single-Turn Rotary Encoders (Optical)
		EP58 Series	58 mm Diameter Absolute Single-Turn Rotary Encoders (Optical)
		ENP Series	60 mm Diameter Absolute Single-Turn Rotary Encoders (Optical)
		MGA50 Series	50 mm Diameter Absolute Single-Turn Rotary Encoders (Magnetic)
		EWS50 Series	50 mm Wire-Type Linear Scale Absolute Encoders (Optical)
A9-4	Absolute (Multi-Turn)	EPM50 Series	50 mm Diameter Absolute Multi-Turn Rotary Encoders (Optical)
		MGAM50 Series	50 mm Diameter Absolute Multi-Turn Rotary Encoders (Magnetic)
A9-5	Manual Handle	ENH Series	Manual Handle Type Pulse Generators
		ENHP Series	Portable Manual Handle Type Pulse Generators
A9-6	Flexible Coupling	ERB Series	Flexible Shaft Coupling

15 mm Diameter Incremental Rotary Encoders

E15 Series



Features

- Ultra-compact (Ø 15 mm) housing and ultra-lightweight (14 g) design
- Easy installation in tight or limited spaces
- Low shaft moment of inertia
- Resolution: 36 pulses per revolution
- Power supply:
5 VDC \pm 5%

Specifications

Model	E15S2-36-2-N-5-R
Resolution	36 PPR
Control output	NPN open collector output
Output phase	A, B
Inflow current	≤ 30 mA
Residual voltage	≤ 0.4 VDC \equiv
Response speed ⁰¹⁾	≤ 1 μ s
Max. response freq.	10 kHz
Max. allowable revolution ⁰²⁾	3,000 rpm
Starting torque	$\leq 10 \times 10^{-4}$ N m
Inertia moment	≤ 0.5 g \cdot cm ² (5×10^{-8} kg \cdot m ²)
Allowable shaft load	Radial: ≤ 200 gf, Thrust: ≤ 200 gf
Unit weight (packaged)	≈ 14 g (≈ 37 g)
Approval	CE
01) Based on cable length: 1 m, I sink: 20 mA	
02) Select resolution to satisfy Max. allowable revolution \geq Max. response revolution [max. response revolution (rpm) = $\frac{\text{max. response frequency}}{\text{resolution}} \times 60$ sec]	
Power supply	5 VDC \pm 5% (ripple P-P: $\leq 5\%$)
Current consumption	≤ 50 mA (no load)
Insulation resistance	Between all terminals and case: ≥ 100 M Ω (500 VDC \equiv megger)
Dielectric strength	Between all terminals and case: 500 VAC \sim 50 / 60 Hz for 1 minute
Vibration	1 mm double amplitude at frequency 10 to 55 Hz (for 1 minute) in each X, Y, Z direction for 2 hours
Shock	≤ 50 G
Ambient temperature	-10 to 70 °C, storage: -20 to 80 °C (no freezing or condensation)
Ambient humidity	35 to 85%RH, storage: 35 to 90%RH (no freezing or condensation)
Protection rating	IP50 (IEC standard)
Connection	Axial wiring type
Cable spec.	Ø 3 mm, 4-wire, 500 mm, flexible PVC insulation shield cable
Wire spec.	AWG30 (0.102 mm, 7-core), insulator diameter: Ø 0.71 mm

18 mm Diameter Incremental Rotary Encoders

E18 Series



Features

- Ultra-compact (Ø 18 mm) housing and ultra-lightweight (12 g) design
- Easy installation in tight or limited spaces
- Low shaft moment of inertia
- Various resolutions:
100, 200, 300, 400 pulses per revolution
- Power supply:
5 VDC \pm 5%

Specifications

Model	E18S□-□-1-N-5-□	E18S□-□-1-V-5-□
Resolution	100 / 200 / 300 / 400 PPR model	
Control output	NPN open collector output	Voltage output
Output phase	A	
Inflow current	≤ 30 mA	-
Residual voltage	≤ 0.4 VDC \pm	≤ 0.4 VDC \pm
Outflow current	-	≤ 10 mA
Response speed ⁰¹⁾	≤ 1 μs	
Max. response freq.	25 kHz	
Max. allowable revolution ⁰²⁾	6,000 rpm	
Starting torque	≤ 9.8 × 10 ⁻⁴ N m	
Inertia moment	≤ 0.5 g·cm ² (5 × 10 ⁻⁸ kg·m ²)	
Allowable shaft load	Radial: ≤ 200 gf, Thrust: ≤ 200 gf	
Unit weight (packaged)	Shaft outer diameter Ø 2 mm model: ≈ 12 g (≈ 35.4 g) Shaft outer diameter Ø 2.5 mm model: ≈ 12 g (≈ 34.2 g)	
Approval	CE ENEC	CE ENEC

01) Based on cable length: 1 m, I sink: 20 mA

02) Select resolution to satisfy Max. allowable revolution ≥ Max. response revolution

$$[\text{max. response revolution (rpm)}] = \frac{\text{max. response frequency}}{\text{resolution}} \times 60 \text{ sec}$$

Power supply	5 VDC \pm 5% (ripple P-P: ≤ 5%)
Current consumption	≤ 50 mA (no load)
Insulation resistance	Between all terminals and case: ≥ 100 MΩ (500 VDC \pm megger)
Dielectric strength	Between all terminals and case: 500 VAC \sim 50 / 60 Hz for 1 minute
Vibration	1 mm double amplitude at frequency 10 to 55 Hz (for 1 minute) in each X, Y, Z direction for 2 hours
Shock	≤ 50 G
Ambient temperature	-10 to 70 °C, storage: -20 to 80 °C (no freezing or condensation)
Ambient humidity	35 to 85%RH, storage: 35 to 90%RH (no freezing or condensation)
Protection rating	IP50 (IEC standard)
Connection	Axial / Radial cable type model
Cable spec.	Ø 1.28 mm, 3-wire, 150 mm, flat ribbon cable
Wire spec.	AWG26 (0.16 mm, 7-core), insulator diameter: Ø 1.28 mm

20 mm Diameter Incremental Rotary Encoders

E20 Series



Features

- Easy installation in tight or limited spaces
- Low shaft moment of inertia
- Various resolutions:
100, 200, 320, 360 pulses per revolution
- Various control output options
- Power supply:
5 VDC \pm 5%, 12 VDC \pm 5%

Specifications

Model	E20□□-□-3-N-□-□	E20□□-□-3-V-□-□	E20□□-□-6-L-5-□
Resolution	100 / 200 / 320 / 360 PPR model		
Control output	NPN open collector output	Voltage output	Line driver output
Output phase	A, B, Z	A, B, Z	A, \bar{A} , B, \bar{B} , Z, \bar{Z}
Inflow current	\leq 30 mA	-	\leq 20 mA
Residual voltage	\leq 0.4 VDC \equiv	\leq 0.4 VDC \equiv	\leq 0.5 VDC \equiv
Outflow current	-	\leq 10 mA	\leq -20 mA
Output voltage	-	-	\geq 2.5 VDC \equiv
Response speed ⁰¹⁾	\leq 1 μ s		\leq 0.5 μ s
Max. response frequency	100 kHz		
Max. allowable revolution ⁰²⁾	6,000 rpm		
Starting torque	\leq 5 \times 10 ⁻⁴ N m		
Inertia moment	\leq 0.5 g \cdot cm ² (5 \times 10 ⁻⁸ kg \cdot m ²)		
Allowable shaft load	Radial: \leq 200 gf, Thrust: \leq 200 gf		
Unit weight	\approx 35 g		
Approval	CE EAC	CE EAC	EAC

01) Based on cable length: 1 m, I sink: 20 mA

02) Select resolution to satisfy Max. allowable revolution \geq Max. response revolution

$$[\text{max. response revolution (rpm)}] = \frac{\text{max. response frequency}}{\text{resolution}} \times 60 \text{ sec}$$

Model	E20□□-□-3-N-□-□	E20□□-□-3-V-□-□	E20□□-□-6-L-5-□
Power supply	5 VDC \pm 5% (ripple P-P: \leq 5%) / 12 VDC \pm 5% (ripple P-P: \leq 5%) model		5 VDC \pm 5% (ripple P-P: \leq 5%)
Current consumption	\leq 60 mA (no load)		\leq 50 mA (no load)
Insulation resistance	Between all terminals and case: \geq 100 M Ω (500 VDC \equiv megger)		
Dielectric strength	Between all terminals and case: 500 VAC \sim 50 / 60 Hz for 1 minute		
Vibration	1 mm double amplitude at frequency 10 to 55 Hz (for 1 minute) in each X, Y, Z direction for 2 hours		
Shock	\leq 50 G		
Ambient temp.	-10 to 70 $^{\circ}$ C, storage: -20 to 80 $^{\circ}$ C (no freezing or condensation)		
Ambient humi.	35 to 85%RH, storage: 35 to 90%RH (no freezing or condensation)		
Protection rating	IP50 (IEC standard)		
Connection	Axial / Radial cable type model		
Cable spec.	\varnothing 3 mm, 5-wire (Line driver output: 8-wire), 1 m, shield cable		

Shaft Type

30 mm Diameter Incremental Rotary Encoders

E30 Series



Features

- Compact Ø 30 mm housing, Ø 4 mm solid shaft
- Easy installation in tight or limited spaces
- Low shaft moment of inertia
- Various resolutions: up to 3000 pulses per revolution
- Various control output options
- Power supply:
5 VDC \pm 5%, 12 - 24 VDC \pm 5%

Specifications

Model	E30S4-□- 3-T-□-□	E30S4-□- 3-N-□-□	E30S4-□- 3-V-□-□	E30S4-□- 6-L-5-□
Resolution	100 / 200 / 360 / 500 / 1,000 / 1,024 / 3,000 PPR model			
Control output	Totem pole output	NPN open collector output	Voltage output	Line driver output
Output phase	A, B, Z	A, B, Z	A, B, Z	A, \bar{A} , B, \bar{B} , Z, \bar{Z}
Inflow current	≤ 30 mA	≤ 30 mA	-	≤ 20 mA
Residual voltage	≤ 0.4 VDC \pm	≤ 0.4 VDC \pm	≤ 0.4 VDC \pm	≤ 0.5 VDC \pm
Outflow current	≤ 10 mA	-	≤ 10 mA	≤ -20 mA
Output voltage (5 VDC \pm)	≥ (power supply -2.0) VDC \pm	-	-	≥ 2.5 VDC \pm
Output voltage (12 - 24 VDC \pm)	≥ (power supply -3.0) VDC \pm	-	-	-
Response speed ⁰¹⁾	≤ 1 μs		≤ 1 μs ⁰²⁾ ≤ 2 μs ⁰³⁾	≤ 0.5 μs
Max. response freq.	300 kHz			
Max. allowable revolution ⁰⁴⁾	5,000 rpm			
Starting torque	≤ 0.002 N m			
Inertia moment	≤ 20 g·cm ² (2 × 10 ⁻⁶ kg·m ²)			
Allowable shaft load	Radial: ≤ 2 kgf, Thrust: ≤ 1 kgf			
Unit weight	≈ 80 g			
Approval	CE EAC	CE EAC	CE EAC	EAC

01) Based on cable length: 2 m, I sink: 20 mA

02) Based on power supply: 5 VDC \pm , output resistance: 820 Ω

03) Based on power supply: 12 - 24 VDC \pm , output resistance: 4.7 kΩ

04) Select resolution to satisfy Max. allowable revolution ≥ Max. response revolution

$$[\text{max.response revolution (rpm)}] = \frac{\text{max.response frequency}}{\text{resolution}} \times 60 \text{ sec}$$

Model	E30S4-□- 3-T-□-□	E30S4-□- 3-N-□-□	E30S4-□- 3-V-□-□	E30S4-□- 6-L-5-□
Power supply	5 VDC \pm 5% (ripple P-P: ≤ 5%) / 12-24 VDC \pm 5% (ripple P-P: ≤ 5%) model			5 VDC \pm 5% (ripple P-P: ≤ 5%)
Current consumption	≤ 80 mA (no load)			≤ 50 mA (no load)
Insulation resistance	Between all terminals and case: ≥ 100 MΩ (500 VDC \pm megger)			
Dielectric strength	Between all terminals and case: 750 VAC ~ 50 / 60 Hz for 1 minute			
Vibration	1 mm double amplitude at frequency 10 to 55 Hz (for 1 minute) in each X, Y, Z direction for 2 hours			
Shock	≤ 50 G			
Ambient temp.	-10 to 70 °C, storage: -25 to 85 °C (no freezing or condensation)			
Ambient humi.	35 to 85%RH, storage: 35 to 90%RH (no freezing or condensation)			
Protection rating	IP50 (IEC standard)			
Connection	Axial cable type / cable connector type model			
Cable spec.	Ø 5 mm, 5-wire (Line driver output: 8-wire), shield cable cable type: 2 m, cable connector type: 250 mm			
Wire spec.	AWG24 (0.08 mm, 40-core), insulator diameter: Ø 1 mm			
Connector spec.	M17 6-pin socket type			M17 9-pin socket type

40 mm Diameter Incremental Rotary Encoders

E40 Series



Features

- Ø 40 mm housing incremental rotary encoders
- Shaft, hollow shaft, blind hollow shaft models available
- Easy installation in tight or limited spaces
- Low shaft moment of inertia
- Various resolutions:
1 to 5000 pulses per revolution
- Various control output options
- Power supply:
5 VDC \pm 5%, 12 - 24 VDC \pm 5%

Specifications

Model	E40□□-□-□- □-T-□-□	E40□□-□-□-□- □-N-□-□	E40□□-□-□-□- □-V-□-□	E40□□-□-□-□- □-L-□-□
Resolution	1 / 2 / 5 / 12 PPR ⁰¹⁾ 10 to 5,000 PPR model			
Control output	Totem pole output	NPN open collector output	Voltage output	Line driver output
Output phase	A, B, Z	A, B, Z	A, B, Z	A, \bar{A} , B, \bar{B} , Z, \bar{Z}
Inflow current	\leq 30 mA	\leq 30 mA	-	\leq 20 mA
Residual voltage	\leq 0.4 VDC \pm	\leq 0.4 VDC \pm	\leq 0.4 VDC \pm	\leq 0.5 VDC \pm
Outflow current	\leq 10 mA	-	\leq 10 mA	\leq -20 mA
Output voltage (5 VDC \pm)	\geq (power supply -2.0) VDC \pm	-	-	\geq 2.5 VDC \pm
Output voltage (12 - 24 VDC \pm)	\geq (power supply -3.0) VDC \pm	-	-	\geq (power supply -3.0) VDC \pm
Response speed⁰²⁾	\leq 1 μ s			\leq 0.5 μ s
Max. response freq.	300 kHz			
Max. allowable revolution⁰³⁾	5,000 rpm			
Starting torque	E40S: \leq 0.004 N m E40H, E40HB: \leq 0.005 N m			
Inertia moment	\leq 40 g·cm ² (4×10^{-8} kg·m ²)			
Allowable shaft load	Radial: \leq 2 kgf, Thrust: \leq 1 kgf			
Unit weight	\approx 120 g			
Approval	CE EAC	CE EAC	CE EAC	EAC

01) Depending on the control output, only A, B or A, \bar{A} , B, \bar{B} are output.

02) Based on cable length: 2 m, I sink: 20 mA

03) Select resolution to satisfy Max. allowable revolution \geq Max. response revolution
 [max. response revolution (rpm) = $\frac{\text{max. response frequency}}{\text{resolution}} \times 60 \text{ sec}$]

50 mm Diameter Incremental Rotary Encoders

E50 Series



Features

- Ø 50 mm housing, Ø 8 mm solid shaft
- Accurate measurement of angle, position, revolution, speed, acceleration, and distance
- Cable type, cable connector type, axial / radial connector types available
- Various resolutions:
1 to 8000 pulses per revolution
- Various control output options
- Power supply:
5 VDC \pm 5%, 12 - 24 VDC \pm 5%

Specifications

Model	E50S8-□-□-□-□-□	E50S8-□-□-□-□-□	E50S8-□-□-□-□-□	E50S8-□-□-□-□-□
Resolution	1 / 2 / 5 PPR ⁰¹⁾ 10 to 8,000 PPR model			
Control output	Totem pole output	NPN open collector output	Voltage output	Line driver output
Output phase	A, B, Z	A, B, Z	A, B, Z	A, \bar{A} , B, \bar{B} , Z, \bar{Z}
Inflow current	≤ 30 mA	≤ 30 mA	-	≤ 20 mA
Residual voltage	≤ 0.4 VDC \pm	≤ 0.4 VDC \pm	≤ 0.4 VDC \pm	≤ 0.5 VDC \pm
Outflow current	≤ 10 mA	-	≤ 10 mA	≤ -20 mA
Output voltage (5 VDC \pm)	≥ (power supply -2.0) VDC \pm	-	-	≥ 2.5 VDC \pm
Output voltage (12 - 24 VDC \pm)	≥ (power supply -3.0) VDC \pm	-	-	≥ (power supply -3.0) VDC \pm
Response speed ⁰²⁾	≤ 1 μs			≤ 0.5 μs
Max. response freq.	300 kHz			
Max. allowable revolution ⁰³⁾	5,000 rpm			
Approval	CE ENEC	CE ENEC	CE ENEC	CE ENEC

01) Depending on the control output, only A, B or A, \bar{A} , B, \bar{B} are output.

02) Based on cable length: 2 m, I sink: 20 mA

03) Select resolution to satisfy Max. allowable revolution ≥ Max. response revolution

$$[\text{max. response revolution (rpm)}] = \frac{\text{max. response frequency}}{\text{resolution}} \times 60 \text{ sec}$$

Connection	Axial cable type	Axial cable connector type	Axial connector type	Radial connector type
Starting torque	≤ 0.007 N m		≤ 0.078 N m	
Inertia moment	≤ 80 g·cm ² (8 × 10 ⁻⁶ kg·m ²)		≤ 400 g·cm ² (4 × 10 ⁻⁵ kg·m ²)	
Allowable shaft load	Radial: ≤ 10 kgf, Thrust: ≤ 2.5 kgf			
Unit weight (packaged)	≈ 275 g (≈ 363 g)		≈ 180 g (≈ 268 g)	
Power supply	5 VDC \pm 5% (ripple P-P: ≤ 5%) / 12 - 24 VDC \pm 5% (ripple P-P: ≤ 5%) model			
Current consumption	Totem pole, NPN open collector, Voltage output: ≤ 80 mA (no load) Line driver output: ≤ 50 mA (no load)			
Insulation resistance	Between all terminals and case: ≥ 100 MΩ (500 VDC \pm megger)			
Dielectric strength	Between all terminals and case: 750 VAC \sim 50 / 60 Hz for 1 minute			
Vibration	1 mm double amplitude at frequency 10 to 55 Hz (for 1 minute) in each X, Y, Z direction for 2 hours			
Shock	≤ 75 G			
Ambient temp.	-10 to 70 °C, storage: -25 to 85 °C (no freezing or condensation)			
Ambient humi.	35 to 85%RH, storage: 35 to 90%RH (no freezing or condensation)			
Protection rating	Axial cable type / cable connector type: IP50 (IEC standard) ⁰¹⁾ Axial / Radial connector type: IP64 (IEC standard)			
Cable spec.	Ø 5 mm, 5-wire (Line driver output: 8-wire), shield cable cable type: 2 m, cable connector type: 250 mm			
Wire spec.	AWG24 (0.08 mm, 40-core), insulator diameter: Ø 1 mm			
Connector spec.	Totem pole, NPN open collector, Voltage output: M17 6-pin socket type Line driver output: M17 9-pin socket type			

01) Protection structure IP64 option is also available to order.

(starting torque: ≤ 0.078 N m, inertia moment: ≤ 400 g·cm² (4 × 10⁻⁵ kg·m²))

58 mm Diameter Incremental Rotary Encoders

E58 Series



Features

- Ø 58 mm flange incremental rotary encoders
- Accurate measurement of angle, position, revolution, speed, acceleration, and distance
- Shaft, hollow shaft, blind hollow shaft models available
- Cable type, cable connector type, axial / radial connector types available
- Various resolutions:
1 to 8000 pulses per revolution
- Various control output options
- Power supply:
5 VDC \pm 5%, 12 - 24 VDC \pm 5%

Specifications

Model	E58□□-□-□-□-□-□ □-□-□-□-□	E58□□□□-□□ □-□-□-□-□	E58□□□□-□□ □-□-□-□-□	E58□□□□-□□ □-□-□-□-□
Resolution	1 / 2 / 5 / 12 PPR ⁰¹⁾ 10 to 8,000 PPR model			
Control output	Totem pole output	NPN open collector output	Voltage output	Line driver output
Output phase	A, B, Z	A, B, Z	A, B, Z	A, \bar{A} , B, \bar{B} , Z, \bar{Z}
Inflow current	≤ 30 mA	≤ 30 mA	-	≤ 20 mA
Residual voltage	≤ 0.4 VDC \pm	≤ 0.4 VDC \pm	≤ 0.4 VDC \pm	≤ 0.5 VDC \pm
Outflow current	≤ 10 mA	-	≤ 10 mA	≤ -20 mA
Output voltage (5 VDC \pm)	≥ (power supply -2.0) VDC \pm	-	-	≥ 2.5 VDC \pm
Output voltage (12 - 24 VDC \pm)	≥ (power supply -3.0) VDC \pm	-	-	≥ (power supply -3.0) VDC \pm
Response speed ⁰²⁾	≤ 1 μs			
Max. response freq.	300 kHz			
Max. allowable revolution ⁰³⁾	5,000 rpm			
Approval	CE EAC	CE EAC	CE EAC	EAC

01) Depending on the control output, only A, B or A, \bar{A} , B, \bar{B} are output.

02) Based on cable length: 2 m, I sink: 20 mA

03) Select resolution to satisfy Max. allowable revolution ≥ Max. response revolution.

[max. response revolution (rpm)] = $\frac{\text{max. response frequency}}{\text{resolution}} \times 60 \text{ sec}$

Shaft type	Shaft clamping type	Shaft synchro type	Hollow type	Hollow Built-in type
Starting torque	≤ 0.004 N m		≤ 0.009 N m	
Inertia moment	≤ 15 g·cm ² (1.5 × 10 ⁻⁶ kg·m ²)		≤ 20 g·cm ² (2 × 10 ⁻⁶ kg·m ²)	
Allowable shaft load	Radial: ≤ 10 kgf, Thrust: ≤ 2.5 kgf		Radial: ≤ 2 kgf, Thrust: ≤ 1 kgf	
Unit weight (packaged)	Varies according to connection type			
Cable type, cable connector type	≈ 310 g (≈ 420 g)	≈ 285 g (≈ 395 g)	≈ 270 g (≈ 380 g)	≈ 270 g (≈ 380 g)
Connector type	≈ 230 g (≈ 340 g)	≈ 205 g (≈ 315 g)	-	≈ 200 g (≈ 310 g)
Power supply	5 VDC \pm 5% (ripple P-P: ≤ 5%) / 12 - 24 VDC \pm 5% (ripple P-P: ≤ 5%) model			
Current consumption	Totem pole, NPN open collector, Voltage output: ≤ 80 mA (no load) Line driver output: ≤ 50 mA (no load)			
Insulation resistance	Between all terminals and case: ≥ 100 MΩ (500 VDC \pm megger)			
Dielectric strength	Between all terminals and case: 750 VAC ~ 50 / 60 Hz for 1 minute			
Vibration	1 mm double amplitude at frequency 10 to 55 Hz (for 1 minute) in each X, Y, Z direction for 2 hours			
Shock	≤ 75 G			
Ambient temp.	-10 to 70 °C, storage: -25 to 85 °C (no freezing or condensation)			
Ambient humi.	35 to 85%RH, storage: 35 to 90%RH (no freezing or condensation)			
Protection rating	IP50 (IEC standard)			
Connection	Shaft type, Hollow Built-in type : Axial cable type / Axial cable connector type / Axial connector type / Radial connector type model Hollow type: Radial cable type / Radial cable connector type model			
Cable spec.	Ø 5 mm, 5-wire (Line driver output: 8-wire), shield cable cable type: 2 m, cable connector type: 250 mm			
Wire spec.	AWG24 (0.08 mm, 40-core), insulator diameter: Ø 1 mm			
Connector spec.	Totem pole, NPN open collector, Voltage output: M17 6-pin socket type Line driver output: M17 9-pin socket type			

Shaft Type

60 mm Diameter Incremental Rotary Encoders

E60 Series



Features

- Ø 60 mm housing, Ø 20 mm hollow shaft
- Accurate measurement of angle, position, revolution, speed, acceleration, and distance
- Various resolutions:
up to 8192 pulses per revolution
- Various control output options
- Power supply:
5 VDC \pm 5%, 12 - 24 VDC \pm 5%

Specifications

Model	E60H20-□- 3-T-□-□	E60H20-□- 3-N-□-□	E60H20-□- 3-V-□-□	E60H20-□- 6-L-□-□
Resolution	100 / 1,024 / 5,000 / 8,192 PPR model			
Control output	Totem pole output	NPN open collector output	Voltage output	Line driver output
Output phase	A, B, Z	A, B, Z	A, B, Z	A, \bar{A} , B, \bar{B} , Z, \bar{Z}
Inflow current	≤ 30 mA	≤ 30 mA	-	≤ 20 mA
Residual voltage	≤ 0.4 VDC \pm	≤ 0.4 VDC \pm	≤ 0.4 VDC \pm	≤ 0.5 VDC \pm
Outflow current	≤ 10 mA	-	≤ 10 mA	≤ -20 mA
Output voltage (5 VDC \pm)	≥ (power supply -2.0) VDC \pm	-	-	≥ 2.5 VDC \pm
Output voltage (12 - 24 VDC \pm)	≥ (power supply -3.0) VDC \pm	-	-	≥ (power supply -3.0) VDC \pm
Response speed ⁰¹⁾	≤ 1 μs			
Max. response frequency	300 kHz			
Max. allowable revolution ⁰²⁾	6,000 rpm			
Starting torque	≤ 0.0147 N m			
Inertia moment	≤ 110 g·cm ² (11 × 10 ⁻⁶ kg·m ²)			
Allowable shaft load	Radial: ≤ 5 kgf, Thrust: ≤ 2.5 kgf			
Unit weight (packaged)	≈ 300 g (≈ 397 g)			
Approval	CE EAC	CE EAC	CE EAC	EAC

01) Based on cable length: 2 m, I sink: 20 mA

02) Select resolution to satisfy Max. allowable revolution ≥ Max. response revolution

[max. response revolution (rpm)] = $\frac{\text{max. response frequency}}{\text{resolution}} \times 60 \text{ sec}$

Power supply	5 VDC \pm 5% (ripple P-P: ≤ 5%) / 12 - 24 VDC \pm 5% (ripple P-P: ≤ 5%) model
Current consumption	Totem pole, NPN open collector, Voltage output: ≤ 80 mA (no load) Line driver output: ≤ 50 mA (no load)
Insulation resistance	Between all terminals and case: ≥ 100 MΩ (500 VDC \pm megger)
Dielectric strength	Between all terminals and case: 750 VAC \sim 50 / 60 Hz for 1 minute
Vibration	1 mm double amplitude at frequency 10 to 55 Hz (for 1 minute) in each X, Y, Z direction for 2 hours
Shock	≤ 100 G
Ambient temp.	-10 to 70 °C, storage: -25 to 85 °C (no freezing or condensation)
Ambient humi.	35 to 85%RH, storage: 35 to 90%RH (no freezing or condensation)
Protection rating	IP50 (IEC standard)
Connection	Radial cable type / Cable connector type model
Cable spec.	Ø 5 mm, 5-wire (line driver output: 8-wire), shield cable cable type: 2 m, cable connector type: 250 mm
Wire spec.	AWG24 (0.08 mm, 40-core), insulator diameter: Ø 1 mm
Connector spec.	Totem pole, NPN open collector, Voltage output: M17 6-pin socket type Line driver output: M17 9-pin socket type

68 mm Diameter Incremental Rotary Encoders

E68 Series



Features

- Ø 68 mm housing, Ø 15 mm solid shaft
- High-strength shaft
(radial load: 20 kgf, thrust load: 10 kgf)
- 180 kHz response frequency
- Radial connector type
- Various resolutions:
500, 600, 1024 pulses per revolution
- Power supply:
5 VDC \pm 5%
- IP65 protection structure (IEC standard)

Specifications

Model	E68S15-□-6-L-5
Resolution	500 / 600 / 1,024 PPR model
Control output	Line driver output
Output phase	A, \bar{A} , B, \bar{B} , Z, \bar{Z}
Inflow current	\leq 20 mA
Residual voltage	\leq 0.5 VDC \equiv
Outflow current	\leq -20 mA
Output voltage	\geq 2.5 VDC \equiv
Response speed ⁰¹⁾	\leq 0.5 μ s
Max. response freq.	180 kHz
Max. allowable revolution ⁰²⁾	6,500 rpm
Starting torque	\leq 0.15 N m
Allowable shaft load	Radial: \leq 20 kgf, Thrust: \leq 10 kgf
Unit weight	\approx 550 g
Approval	ERC

01) Based on cable length: 1 m, I sink: 20 mA

02) Select resolution to satisfy Max. allowable revolution \geq Max. response revolution

$$[\text{max. response revolution (rpm)} = \frac{\text{max. response frequency}}{\text{resolution}} \times 60 \text{ sec}]$$

Power supply	5 VDC \pm 5% (ripple P-P: \leq 5%)
Current consumption	\leq 50 mA (no load)
Insulation resistance	Between all terminals and case: \geq 100 M Ω (500 VDC \equiv megger)
Dielectric strength	Between all terminals and case: 750 VAC \sim 50 / 60 Hz for 1 minute
Vibration	1 mm double amplitude at frequency 10 to 55 Hz (for 1 minute) in each X, Y, Z direction for 2 hours
Shock	\lesssim 50 G
Ambient temp.	-10 to 70 °C, storage: -25 to 85 °C (no freezing or condensation)
Ambient humi.	35 to 85%RH, storage: 35 to 90%RH (no freezing or condensation)
Protection rating	IP65 (IEC standard)
Connection	Radial connector type
Connector spec.	1-1/4-18UNEF-2A socket type

80 mm Diameter Incremental Rotary Encoders

E80 Series



Features

- Ø 80 mm housing,
Ø 30 mm / Ø 32 mm hollow shaft
- Install directly on motors or rotating shaft.
Couplings not required.
- Various resolutions:
up to 3200 pulses per revolution
- Various control output options
- Power supply:
5 VDC \pm 5%, 12 - 24 VDC \pm 5%

Specifications

Model	E80H□-□- 3-T-□-□	E80H□-□- 3-N-□-□	E80H□-□- 3-V-□-□	E80H□-□- 6-L-5-□
Resolution	60 / 100 / 360 / 500 / 512 / 1,024 / 3,200 PPR model			
Control output	Totem pole output	NPN open collector output	Voltage output	Line driver output
Output phase	A, B, Z	A, B, Z	A, B, Z	A, \bar{A} , B, \bar{B} , Z, \bar{Z}
Inflow current	≤ 30 mA	≤ 30 mA	-	≤ 20 mA
Residual voltage	≤ 0.4 VDC \pm	≤ 0.4 VDC \pm	≤ 0.4 VDC \pm	≤ 0.5 VDC \pm
Outflow current	≤ 10 mA	-	≤ 10 mA	≤ -20 mA
Output voltage (5 VDC \pm)	≥ (power supply -2.0) VDC \pm	-	-	≥ 2.5 VDC \pm
Output voltage (12 - 24 VDC \pm)	≥ (power supply -3.0) VDC \pm	-	-	≥ (power supply -3.0) VDC \pm
Response speed ⁰¹⁾	≤ 1 μs			
Max. response freq.	200 kHz			
Max. allowable revolution ⁰²⁾	3,600 rpm			
Starting torque	≤ 0.02 N m			
Inertia moment	≤ 800 g·cm ² (8 × 10 ⁻⁵ kg·m ²)			
Allowable shaft load	Radial: ≤ 5 kgf, Thrust: ≤ 2.5 kgf			
Unit weight	≈ 560 g			
Approval	CE EAC	CE EAC	CE EAC	EAC

01) Based on cable length: 2 m, I sink: 20 mA

02) Select resolution to satisfy Max. allowable revolution ≥ Max. response revolution

$$[\text{max. response revolution (rpm)}] = \frac{\text{max. response frequency}}{\text{resolution}} \times 60 \text{ sec}$$

Model	E80H□-□- 3-T-□-□	E80H□-□- 3-N-□-□	E80H□-□- 3-V-□-□	E80H□-□- 6-L-5-□
Power supply	5 VDC \pm 5% (ripple P-P: ≤ 5%) / 12 - 24 VDC \pm 5% (ripple P-P: ≤ 5%) model			
Current consumption	Totem pole, NPN open collector, Voltage output: ≤ 80 mA (no load) Line driver output: ≤ 50 mA (no load)			
Insulation resistance	Between all terminals and case: ≥ 100 MΩ (500 VDC \pm megger)			
Dielectric strength	Between all terminals and case: 750 VAC \sim 50 / 60 Hz for 1 minute			
Vibration	1 mm double amplitude at frequency 10 to 55 Hz (for 1 minute) in each X, Y, Z direction for 2 hours			
Shock	≤ 75 G			
Ambient temp.	-10 to 70 °C, storage: -25 to 85 °C (no freezing or condensation)			
Ambient humi.	35 to 85%RH, storage: 35 to 90%RH (no freezing or condensation)			
Protection rating	IP50 (IEC standard)			
Connection	Radial cable type / cable connector type model			
Cable spec.	Ø 5 mm, 5-wire (Line driver output: 8-wire), shield cable cable type: 2 m, cable connector type: 250 mm			
Wire spec.	AWG24 (0.08 mm, 40-core), insulator diameter: Ø 1 mm			
Connector spec.	Totem pole, NPN open collector, Voltage output: M17 6-pin socket type Line driver output: M17 9-pin socket type			

88 mm Diameter Incremental Rotary Encoders

E88 Series



Features

- Ø 88 mm housing / Ø 30 mm hollow shaft
- Install directly on rotating shafts of elevator winding machines. No couplings required.
- Power supply:
5 VDC \pm 5%, 12 - 24 VDC \pm 5%
- Output types: complementary, line driver

Specifications

Model	E88H30-1024-2-15	E88H30-1024-2-L-5
Resolution	1,024 PPR	
Control output	Complemental output	Line driver output
Output phase	A, B	A, \bar{A} , B, \bar{B} , Z, \bar{Z}
Inflow current	≤ 15 mA	≤ 20 mA
Residual voltage	≤ 2.0 VDC \equiv	≤ 0.5 VDC \equiv
Outflow current	≤ 15 mA	≤ -20 mA
Output voltage	≥ 10 VDC \equiv	≥ 2.5 VDC \equiv
Response speed	$\leq 1 \mu\text{s}$ ⁰¹⁾	$\leq 0.5 \mu\text{s}$ ⁰²⁾
Max. response freq.	150 kHz	
Max. allowable revolution ⁰³⁾	3,600 rpm	
Starting torque	≤ 0.06 N m	
Inertia moment	≤ 800 g $\cdot\text{cm}^2$ (8×10^{-5} kg $\cdot\text{m}^2$)	
Allowable shaft load	Radial: ≤ 5 kgf, Thrust: ≤ 2.5 kgf	
Unit weight	≈ 1.45 kg (≈ 1.49 kg)	
Approval	CE EAC	EAC

01) Based on cable length: 8 m, load resistance: 1 k Ω

02) Based on cable length: 8 m, I sink: 20 mA

03) Select resolution to satisfy Max. allowable revolution \geq Max. response revolution

$$[\text{max. response revolution (rpm)}] = \frac{\text{max. response frequency}}{\text{resolution}} \times 60 \text{ sec}$$

Model	E88H30-1024-2-15	E88H30-1024-2-L-5
Power supply	15 VDC \pm 5% (ripple P-P: $\leq 5\%$)	5 VDC \pm 5% (ripple P-P: $\leq 5\%$)
Current consumption	≤ 60 mA (no load)	≤ 50 mA (no load)
Insulation resistance	Between all terminals and case: ≥ 100 M Ω (500 VDC \equiv megger)	
Dielectric strength	Between all terminals and case: 750 VAC \sim 50 / 60 Hz for 1 minute	
Vibration	1 mm double amplitude at frequency 10 to 55 Hz (for 1 minute) in each X, Y, Z direction for 2 hours	
Shock	≤ 100 G	
Ambient temp.	-10 to 70 °C, storage: -25 to 85 °C (no freezing or condensation)	
Ambient humi.	35 to 85%RH, storage: 35 to 90%RH (no freezing or condensation)	
Protection rating	IP50 (IEC standard)	
Connection	Radial cable type	
Cable spec.	\varnothing 6 mm, 6-wire (Line driver output: 8-wire), 8 m, shield cable	
Wire spec.	AWG24 (0.16 mm, 11-core), insulator diameter: \varnothing 1 mm	AWG24 (0.08 mm, 40-core), insulator diameter: \varnothing 1 mm

100 mm Diameter Incremental Rotary Encoders

E100 Series



Features

- Ø 100 mm housing, Ø 35 mm hollow shaft
- Ideal for application in elevator systems
- Various resolutions:
512, 1024, 10000 pulses per revolution
- Various control output options
- Power supply:
5 VDC \pm 5%, 12 - 24 VDC \pm 5%

Specifications

Model	E100H35-□-3-T-□	E100H35-□-3-N-□	E100H35-□-3-V-□	E100H35-□-6-L-□
Resolution	512 / 1,024 / 10,000 PPR model			
Control output	Totem pole output	NPN open collector output	Voltage output	Line driver output
Output phase	A, B, Z	A, B, Z	A, B, Z	A, \bar{A} , B, \bar{B} , Z, \bar{Z}
Inflow current	\leq 30 mA	\leq 30 mA	-	\leq 20 mA
Residual voltage	\leq 0.4 VDC \equiv	\leq 0.4 VDC \equiv	\leq 0.4 VDC \equiv	\leq 0.5 VDC \equiv
Outflow current	\leq 10 mA	-	\leq 10 mA	\leq -20 mA
Output voltage (5 VDC \equiv)	\geq (power supply -2.0) VDC \equiv	-	-	\geq 2.5 VDC \equiv
Output voltage (12 - 24 VDC \equiv)	\geq (power supply -3.0) VDC \equiv	-	-	\geq (power supply -3.0) VDC \equiv
Response speed ⁰¹⁾	\leq 1 μ s			
Max. response freq.	300 kHz			
Max. allowable revolution ⁰²⁾	3,600 rpm			
Starting torque	\leq 0.03 N m			
Inertia moment	\leq 800 g \cdot cm ² (8×10^{-5} kg \cdot m ²)			
Allowable shaft load	Radial: \leq 5 kgf, Thrust: \leq 2.5 kgf			
Unit weight	\approx 1130 g (\approx 1400 g)			
Approval	CE EAC	CE EAC	CE EAC	EAC

01) Based on cable length: 2 m, I sink: 20 mA

02) Select resolution to satisfy Max. allowable revolution \geq Max. response revolution

$$[\text{max. response revolution (rpm)}] = \frac{\text{max. response frequency}}{\text{resolution}} \times 60 \text{ sec}$$

Power supply	5 VDC \pm 5% (ripple P-P: \leq 5%) / 12 - 24 VDC \pm 5% (ripple P-P: \leq 5%) model
Current consumption	Totem pole, NPN open collector, Voltage output: \leq 80 mA (no load) Line driver output: \leq 50 mA (no load)
Insulation resistance	Between all terminals and case: \geq 100 M Ω (500 VDC \equiv megger)
Dielectric strength	Between all terminals and case: 750 VAC \sim 50 / 60 Hz for 1 minute
Vibration	1 mm double amplitude at frequency or 300 m/s ² 10 to 55 Hz (for 1 minute) in each X, Y, Z direction for 2 hours
Shock	\leq 75 G
Ambient temp.	-10 to 70 °C, storage: -25 to 85 °C (no freezing or condensation)
Ambient humi.	35 to 85%RH, storage: 35 to 90%RH (no freezing or condensation)
Protection rating	IP50 (IEC standard)
Connection	Radial connector type
Cable spec.	\varnothing 5 mm, 5-wire (line driver output: \varnothing 6 mm, 8-wire), 2 m, shield cable
Wire spec.	AWG24 (0.08 mm, 40-core), insulator diameter: \varnothing 1 mm
Connector spec.	Totem pole, NPN open collector, Voltage output: SCN-16-7P Line driver output: SCN-20-10P

Side Mount Type Incremental Rotary Encoders

ENA Series



Features

- Die-cast external housing provides excellent immunity to impact
- Designed to mount directly onto frames
- Various resolutions:
1 to 5000 pulses per revolution
- Various control output options
- Power supply:
5 VDC \pm 5%, 12 - 24 VDC \pm 5%

Specifications

Model	ENA-□-□-□-□-□	ENA-□-□-□-□-□	ENA-□-□-□-□-□
Resolution	1 / 2 / 5 PPR ⁰¹⁾ 10 to 5,000 PPR model		
Control output	Totem pole output	NPN open collector output	Voltage output
Output phase	A, B / A, B, Z output model	A, B / A, B, Z output model	A, B / A, B, Z output model
Inflow current	≤ 30 mA	≤ 30 mA	-
Residual voltage	≤ 0.4 VDC \pm	≤ 0.4 VDC \pm	≤ 0.4 VDC \pm
Outflow current	≤ 10 mA	-	≤ 10 mA
Output voltage (5 VDC\pm)	≥ (power supply -2.0) VDC \pm	-	-
Output voltage (12 - 24 VDC\pm)	≥ (power supply -3.0) VDC \pm	-	-
Response speed⁰²⁾	≤ 1 μs		
Max. response freq.	300 kHz		
Max. allowable revolution⁰³⁾	5,000 rpm		
Starting torque	≤ 0.007 N m		
Inertia moment	≤ 80 g·cm ² (8 × 10 ⁻⁶ kg·m ²)		
Allowable shaft load	Radial: ≤ 10 kgf, Thrust: ≤ 2.5 kgf		
Unit weight	≈ 345 g		
Approval	CE ENEC		

01) Depending on the control output, only A, B are output.

02) Based on cable length: 2 m, I sink: 20 mA

03) Select resolution to satisfy Max. allowable revolution ≥ Max. response revolution

$$[\text{max. response revolution (rpm)}] = \frac{\text{max. response frequency}}{\text{resolution}} \times 60 \text{ sec}$$

Power supply	5 VDC \pm 5% (ripple P-P: ≤ 5%) / 12 - 24 VDC \pm 5% (ripple P-P: ≤ 5%) model
Current consumption	≤ 80 mA (no load)
Insulation resistance	Between all terminals and case: ≥ 100 MΩ (500 VDC \pm megger)
Dielectric strength	Between all terminals and case: 750 VAC~ 50 / 60 Hz for 1 minute
Vibration	1 mm double amplitude at frequency 10 to 55 Hz (for 1 minute) in each X, Y, Z direction for 2 hours
Shock	≤ 75 G
Ambient temp.	-10 to 70 °C, storage: -25 to 85 °C (no freezing or condensation)
Ambient humi.	35 to 85%RH, storage: 35 to 90%RH (no freezing or condensation)
Protection rating	IP50 (IEC standard)
Connection	Radial connector type
Cable spec.	∅ 5 mm, 2 m, shield cable A, B phase output model: 4-wire / A, B, Z phase output model: 5-wire
Wire spec.	AWG24 (0.08 mm, 40-core), insulator diameter: ∅ 1 mm
Connector spec.	A, B phase output model: SCN-16-4P socket type A, B, Z phase output model: SCN-16-5P socket type

Wheel Type Incremental Rotary Encoders

ENC Series

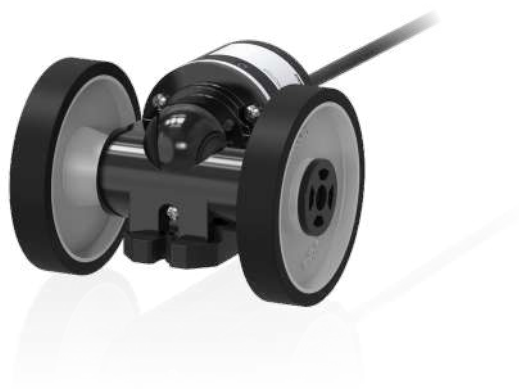

Features

- Wheel type encoders ideal for measuring length or speed of continuously moving objects
- Output waveform of measured distance is proportional to International Weights and Measures (meters / inches)
- Power supply:
5 VDC \pm 5%, 12 - 24 VDC \pm 5%

Specifications

Model	ENC-1-□-T-□-□	ENC-1-□-N-□-□	ENC-1-□-V-□-□
Min. measuring unit [pulse]	1 mm / 1 cm / 1 m / 0.01 yd / 0.1 yd / 1 yd model		
Control output	Totem pole output	NPN open collector output	Voltage output
Output phase	A, B	A, B	A, B
Inflow current	\leq 30 mA	\leq 30 mA	-
Residual voltage	\leq 0.4 VDC \equiv	\leq 0.4 VDC \equiv	\leq 0.4 VDC \equiv
Outflow current	\leq 10 mA	-	\leq 10 mA
Output voltage (5 VDC \equiv)	\geq (power supply -2.0) VDC \equiv	-	-
Output voltage (12 - 24 VDC \equiv)	\geq (power supply -3.0) VDC \equiv	-	-
Response speed ⁰¹⁾	\leq 1 μ s		
Max. response freq.	180 kHz		
Max. allowable revolution ⁰²⁾	5,000 rpm		
Starting torque	Dependent on the coefficient of friction		
Unit weight	\approx 494 g		
Approval	CE EAC	CE EAC	CE EAC

01) Based on cable length: 2 m, I sink: 20 mA

02) Select resolution to satisfy Max. allowable revolution \geq Max. response revolution

$$[\text{max. response revolution (rpm)}] = \frac{\text{max. response frequency}}{\text{resolution}} \times 60 \text{ sec}$$

Power supply	5 VDC \pm 5% (ripple P-P: \leq 5%) / 12 - 24 VDC \pm 5% (ripple P-P: \leq 5%) model
Current consumption	\leq 80 mA (no load)
Insulation resistance	Between all terminals and case: \geq 100 M Ω (500 VDC \equiv megger)
Dielectric strength	Between all terminals and case: 750 VAC \sim 50 / 60 Hz for 1 minute
Vibration	1 mm double amplitude at frequency 10 to 55 Hz (for 1 minute) in each X, Y, Z direction for 2 hours
Shock	\leq 75 G
Ambient temp.	-10 to 70 °C, storage: -25 to 85 °C (no freezing or condensation)
Ambient humi.	35 to 85%RH, storage: 35 to 90%RH (no freezing or condensation)
Protection rating	IP50 (IEC standard)
Connection	Axial cable type / Cable connector type model
Cable spec.	\varnothing 5 mm, 4-wire, shield cable cable type: 2 m, cable connector type: 250 mm
Wire spec.	AWG24 (0.08 mm, 40-core), insulator diameter: \varnothing 1 mm
Connector spec.	M17 6-pin socket type

18 mm Diameter Sine Wave Incremental Rotary Encoders

E18-A Series



Features

- Ultra-compact (Ø 18 mm) housing and ultra-lightweight (10 g) design
- Easy installation in tight or limited spaces
- Low shaft moment of inertia
- Power supply:
5 VDC \pm 5%
- No Amp. output

Specifications

Model	E18S□-□-1-A-5-□
Resolution	200 / 300 PPR model
Control output	Quasi-sinusoidal (No Amp. output)
Output phase	A
Output waveform	Quasi-sinusoidal
Output signal amplitude	≥ 150 mV _{p-p}
Output signal amplitude variation	$\leq 40\%$
Max. response freq.	10 kHz
Max. allowable revolution ⁰¹⁾	3,000 rpm
LED optical elements	Current I _F : ≤ 50 mA Reverse voltage V _R : ≤ 5 VDC \equiv Power consumption P _D : ≤ 95 mW
Photo transistor optical elements	C-E voltage V _{CE0} : ≤ 30 VDC \equiv E-C voltage V _{EC0} : ≤ 5 VDC \equiv C current I _C : ≤ 20 mA C power consumption P _C : ≤ 75 mW
Starting torque	$\leq 10 \times 10^{-4}$ N m
Inertia moment	≤ 0.5 g·cm ² (5×10^{-8} kg·m ²)
Allowable shaft load	Radial: ≤ 200 gf, Thrust: ≤ 200 gf
Unit weight (packaged)	Shaft outer diameter Ø 2 mm model: ≈ 10.1 g (≈ 33.5 g) Shaft outer diameter Ø 2.5 mm model: ≈ 10.1 g (≈ 32.3 g)
Approval	CE cULus ENEC

01) Select resolution to satisfy Max. allowable revolution \geq Max. response revolution

$$[\text{max. response revolution (rpm)}] = \frac{\text{max. response frequency}}{\text{resolution}} \times 60 \text{ sec}$$

Power supply	5 VDC \equiv $\pm 5\%$ (ripple P-P: $\leq 5\%$)
Insulation resistance	Between all terminals and case: ≥ 100 M Ω (500 VDC \equiv megger)
Dielectric strength	Between all terminals and case: 500 VAC \sim 50 / 60 Hz for 1 minute
Vibration	1 mm double amplitude at frequency 10 to 55 Hz (for 1 minute) in each X, Y, Z direction for 2 hours
Shock	≤ 50 G
Ambient temperature	-10 to 50 °C, storage: -20 to 80 °C (no freezing or condensation)
Ambient humidity	35 to 85%RH, storage: 35 to 90%RH (no freezing or condensation)
Protection rating	IP50 (IEC standard)
Connection	Axial / Radial cable type model
Cable spec.	Ø 1 mm, 4-wire, 150 mm, flat ribbon cable
Wire spec.	AWG26 (0.16 mm, 7-core), insulator diameter: Ø 0.98 mm

58 mm Diameter Sine Wave Incremental Rotary Encoders

E58-A Series



Features

- Tapered shaft
- Analog sine wave operational amplifier (OP Amp.) output
- Power supply: 5 VDC \pm 5%

Specifications

Model	E58S9.25-2048-10-A-5-□
Resolution	2,048 PPR
Control output	Analog sine wave OP Amp. output
Output phase	A, \bar{A} , B, \bar{B} , Z, \bar{Z} , C, \bar{C} , D, \bar{D}
Output current	≤ 10 mA
Output voltage V_{p-p}	0.5 ± 0.1 VDC \equiv
DC OFFSET V_{ref}	2.5 ± 0.3 VDC \equiv
Max. response frequency	200 kHz
Max. allowable revolution	6,000 rpm
Shaft	Taper shaft $\varnothing 9.25$ mm, Taper 1 : 10
Starting torque	≤ 0.0098 N m
Inertia moment	≤ 15 g \cdot cm 2 (1.5×10^{-6} kg \cdot m 2)
Allowable shaft load	Radial: ≤ 10 kgf, Thrust: ≤ 2.5 kgf
Unit weight (packaged)	≈ 930 g (≈ 1.02 kg)
Approval	CE EAC
Power supply	5 VDC \equiv $\pm 5\%$ (ripple P-P: $\leq 5\%$)
Current consumption	≤ 120 mA (no load)
Insulation resistance	Between all terminals and case: ≥ 100 M Ω (500 VDC \equiv megger)
Dielectric strength	Between all terminals and case: 750 VAC \sim 50 / 60 Hz for 1 minute
Vibration	1 mm double amplitude at frequency 10 to 55 Hz (for 1 minute) in each X, Y, Z direction for 2 hours
Shock	≤ 100 G
Ambient temp.	-20 to 100 °C, storage: -25 to 100 °C (no freezing or condensation)
Ambient humi.	35 to 85%RH, storage: 35 to 90%RH (no freezing or condensation)
Protection rating	IP50 (IEC standard)
Connection	Axial / Radial cable type model
Cable spec.	$\varnothing 6$ mm, 17-wire, 9 m, shield cable
Wire spec.	AWG28 (0.08 mm, 17-core), insulator diameter: $\varnothing 0.8$ mm

60 mm Diameter Sine Wave Incremental Rotary Encoders

E60-A Series



Features

- \varnothing 60 mm housing, \varnothing 20 mm hollow shaft
- Analog sine wave operational amplifier (op-amp) output
- Power Supply:
5 VDC \pm 5%

Specifications

Model	E60H20-2048-10-A-5-□
Resolution	2,048 PPR
Control output	Analog sine wave OP Amp. output
Output phase	A, \bar{A} , B, \bar{B} , Z, \bar{Z} , C, \bar{C} , D, \bar{D}
Output current	\leq 10 mA
Output voltage V_{p-p}	0.5 \pm 0.1 VDC \pm
DC OFFSET V_{DC}	2.5 \pm 0.3 VDC \pm
Max. response frequency	200 kHz
Max. allowable revolution	6,000 rpm
Starting torque	\leq 0.02 N m
Inertia moment	\leq 110 g \cdot cm ² (11×10^{-6} kg \cdot m ²)
Allowable shaft load	Radial: \leq 5 kgf, Thrust: \leq 2.5 kgf
Unit weight (packaged)	\approx 720 g (\approx 750 g)
Approval	CE [RE]
Power supply	5 VDC \pm 5% (ripple P-P: \leq 5%)
Current consumption	\leq 120 mA (no load)
Insulation resistance	Between all terminals and case: \geq 100 M Ω (500 VDC \pm megger)
Dielectric strength	Between all terminals and case: 750 VAC \sim 50 / 60 Hz for 1 minute
Vibration	1 mm double amplitude at frequency 10 to 55 Hz (for 1 minute) in each X, Y, Z direction for 2 hours
Shock	\leq 100 G
Ambient temp.	-20 to 100 °C, storage: -25 to 100 °C (no freezing or condensation)
Ambient humi.	35 to 85%RH, storage: 35 to 90%RH (no freezing or condensation)
Protection rating	IP40 (IEC standard)
Connection	Axial / Radial cable type model
Cable spec.	\varnothing 6 mm, 17-wire, 9 m, shield cable
Wire spec.	AWG28 (0.08 mm, 17-core), insulator diameter: \varnothing 0.8 mm

50 mm Diameter Absolute Single-Turn Rotary Encoders (Optical)

EP50 Series



Features

- Ø 50 mm housing, Ø 8 mm solid shaft
- Various output code options:
BCD, binary, Gray code
- Various resolutions:
up to 10-bit (1024 divisions)
- IP64 protection structure (IEC standard)

Specifications

Model	EP50S8-□□-□□-□-□	EP50S8-□□-□□-□-□-□
Resolution ⁰¹⁾	≤ 1024 division	
Output code	BCD / Binary / Gray code model	
Control output	NPN open collector output	PNP open collector output
Inflow current	≤ 32 mA	-
Residual voltage	≤ 1 VDC≐	
Outflow current	-	≤ 32 mA
Output voltage	-	≥ (power supply -1.5) VDC≐
Response speed ⁰²⁾	T _{on} ≤ 800 nsec, T _{off} ≤ 800 nsec	
Max. response freq.	35 kHz	
Max. allowable revolution ⁰³⁾	3,000 rpm	
Starting torque	≤ 0.0069 N m	
Inertia moment	≤ 40 g·cm ² (4 × 10 ⁻⁶ kg·m ²)	
Allowable shaft load	Radial: 10 kgf, Thrust: 2.5 kgf	
Unit weight (packaged)	≈ 398 g (≈ 482 g)	
Approval	CE EAC	

01) Refer to resolution in 'Output Phase / Output Angle'.

02) Based on cable length: 2 m, I_{sink} = 32 mA

03) Select resolution to satisfy Max. allowable revolution ≥ Max. response revolution

$$[\text{max. response revolution (rpm)}] = \frac{\text{max. response frequency}}{\text{resolution}} \times 60 \text{ sec}$$

Power supply	5 VDC≐ ± 5% (ripple P-P: ≤ 5%) / 12 - 24 VDC≐ ± 5% (ripple P-P: ≤ 5%) model
Current consumption	≤ 100 mA (no load)
Insulation resistance	Between all terminals and case: ≥ 100 MΩ (500 VDC≐ megger)
Dielectric strength	Between all terminals and case: 750 VAC~ 50 / 60 Hz for 1 minute
Vibration	1 mm double amplitude at frequency 10 to 55 Hz (for 1 minute) in each X, Y, Z direction for 2 hours
Shock	≤ 50 G
Ambient temp.	-10 to 70 °C, storage: -25 to 85 °C (no freezing or condensation)
Ambient humi.	35 to 85%RH, storage: 35 to 90%RH (no freezing or condensation)
Protection rating	IP64 (IEC standard)
Connection	Axial cable type (cable gland)
Cable spec.	Ø 7 mm, 15-wire, 2m, shield cable
Wire spec.	AWG28 (0.08 mm, 40-core), insulator diameter: Ø 0.8 mm

58 mm Diameter Absolute Single-Turn Rotary Encoders (Optical)

EP58 Series



Features

- Ø 58 mm flange single-turn absolute rotary encoders
- Shaft, blind hollow shaft models available
- Various output codes available: BCD, binary, Gray code
- Various resolutions: up to 10-bit (1024 divisions)
- Power supply: 5 VDC \pm 5%, 12 - 24 VDC \pm 5%

Specifications

Model	EP58□-□-□□-N-□	EP58□-□-□□-P-□
Resolution ⁰¹⁾	≤ 1024 division	
Output code	BCD / Binary / Gray code model	
Control output	NPN open collector output	PNP open collector output
Inflow current	≤ 32 mA	-
Residual voltage	≤ 1 VDC \pm	-
Outflow current	-	≤ 32 mA
Output voltage	-	≥ (power supply - 1.5) VDC \pm
Response speed ⁰²⁾	T _{ON} ≤ 800 nsec, T _{OFF} ≤ 800 nsec	
Max. response freq.	35 kHz	
Max. allowable revolution ⁰³⁾	3,000 rpm	
Approval	CE ENEC	

01) Refer to resolution in 'Output Phase / Output Angle'

02) Based on cable length: 2 m, I_{sink} = 32 mA

03) Select resolution to satisfy Max. allowable revolution ≥ Max. response revolution

$$[\text{max. response revolution (rpm)}] = \frac{\text{max. response frequency}}{\text{resolution}} \times 60 \text{ sec}$$

Shaft type	Shaft clamping type	Shaft synchro type	Hollow Built-in type
Starting torque	≤ 0.004 N m		≤ 0.009 N m
Inertia moment	≤ 15 g·cm ² (1.5 × 10 ⁻⁶ kg·m ²)		≤ 20 g·cm ² (2 × 10 ⁻⁶ kg·m ²)
Allowable shaft load	Radial: ≤ 10 kgf, Thrust: ≤ 2.5 kgf		Radial: ≤ 2 kgf, Thrust: ≤ 1 kgf
Unit weight (packaged)	≈ 435 g (≈ 545 g)	≈ 415 g (≈ 525 g)	≈ 410 g (≈ 520 g)
Power supply	5 VDC \pm 5% (ripple P-P: ≤ 5%) / 12 - 24 VDC \pm 5% (ripple P-P: ≤ 5%) model		
Current consumption	≤ 100 mA (no load)		
Insulation resistance	Between all terminals and case: ≥ 100 MΩ (500 VDC \pm megger)		
Dielectric strength	Between all terminals and case: 750 VAC ~ 50 / 60 Hz for 1 minute		
Vibration	1 mm double amplitude at frequency 10 to 55 Hz (for 1 minute) in each X, Y, Z direction for 2 hours		
Shock	≤ 50 G		
Ambient temp.	-10 to 70 °C, storage: -25 to 85 °C (no freezing or condensation)		
Ambient humi.	35 to 85%RH, storage: 35 to 90%RH (no freezing or condensation)		
Protection rating	IP50 (IEC standard)		
Connection	Axial cable type (cable gland)		
Cable spec.	Ø 7 mm, 15-wire, 2 m, shield cable		

60 mm Diameter Absolute Single-Turn Rotary Encoders (Optical)

ENP Series



Features

- Ø 60 mm housing, Ø 10 mm solid shaft
- Output code: BCD code
- Various resolutions: up to 360 divisions
- Power supply:
5 VDC \pm 5%, 12 - 24 VDC \pm 5%

Specifications

Model	ENP-1□□□-□-N	ENP-1□□□-□-P
Resolution ⁰¹⁾	≤ 360 division	
Output code	BCD code	
Control output	NPN open collector output	PNP open collector output
Inflow current	≤ 32 mA	-
Residual voltage	≤ 1 VDC \pm	
Outflow current	-	≤ 32 mA
Output voltage	-	≥ (power supply - 1.5) VDC \pm
Response speed ⁰²⁾	T _{ON} ≤ 800 nsec, T _{OFF} ≤ 800 nsec	
Max. response freq.	20 kHz	
Max. allowable revolution ⁰³⁾	3,600 rpm	
Starting torque	≤ 0.05 N m	
Inertia moment	≤ 300 g·cm ² (3 × 10 ⁻⁵ kg·m ²)	
Allowable shaft load	Radial: 10 kgf, Thrust: 2.5 kgf	
Unit weight (packaged)	≈ 400 g (≈ 478 g)	
Approval	EAC	

01) Refer to resolution in "Output Phase / Output Angle".

02) Based on cable length: 1 m, I_{sink} = 32 mA

03) Select resolution to satisfy Max. allowable revolution ≥ Max. response revolution

$$[\text{max. response revolution (rpm)}] = \frac{\text{max. response frequency}}{\text{resolution}} \times 60 \text{ sec}$$

Power supply	5 VDC \pm 5% (ripple P-P: ≤ 5%) / 12 - 24 VDC \pm 5% (ripple P-P: ≤ 5%) model
Current consumption	≤ 100 mA (no load)
Insulation resistance	Between all terminals and case: ≥ 100 MΩ (500 VDC \pm megger)
Dielectric strength	Between all terminals and case: 750 VAC \sim 50 / 60 Hz for 1 minute
Vibration	1 mm double amplitude at frequency 10 to 55 Hz (for 1 minute) in each X, Y, Z direction for 2 hours
Shock	≤ 75 G
Ambient temp.	-10 to 70 °C, storage: -25 to 85 °C (no freezing or condensation)
Ambient humi.	35 to 85%RH, storage: 35 to 90%RH (no freezing or condensation)
Protection rating	IP50 (IEC standard)
Connection	Axial cable type
Cable spec.	Ø 8 mm, 12-wire, 1 m, double shield cable
Wire spec.	AWG24 (0.08 mm, 40-core), insulator diameter - power wire: Ø 1.5 mm, signal wire: Ø 1 mm

50 mm Diameter Absolute Single-Turn Rotary Encoders (Magnetic)

MGA50 Series



Features

- High accuracy in harsh environments including shock, vibration, dust, and humidity (compared to optical encoders)
- Longer service life compared to optical encoders
- Various output code options: BCD, binary, Gray
- Various resolutions: up to 10-bit (1024 divisions)
- Power supply: 5 VDC \pm 5%, 12 - 24 VDC \pm 5%
- IP50 protection structure (IEC standard)

Specifications

Model	MGA50S8-□-□□-N-□
Resolution ⁰¹⁾	≤ 1024 division
Output code	BCD / Binary / Gray code model
Control output	NPN open collector output
Inflow current	≤ 32 mA
Residual voltage	≤ 1 VDC \equiv
Output logic	Negative logic output
Response speed ⁰²⁾	≤ 1 μ s
Max. response freq.	30 kHz
Max. allowable revolution ⁰³⁾	3,000 rpm
Starting torque	≤ 0.007 N m
Inertia moment	≤ 80 g·cm ² (8×10^{-6} kg·m ²)
Allowable shaft load	Radial: 10 kgf, Thrust: 2.5 kgf
Unit weight (packaged)	≈ 270 g (= 400 g)
Approval	CE ENEC

01) Refer to resolution in 'Output Phase / Output Angle'.

02) Based on cable length: 2 m, I sink = 32 mA

03) Select resolution to satisfy Max. allowable revolution \geq Max. response revolution

$$[\text{max. response revolution (rpm)} = \frac{\text{max. response frequency}}{\text{resolution}} \times 60 \text{ sec}]$$

Power supply	5 VDC \pm 5% (ripple P-P: \leq 5%) / 12 - 24 VDC \pm 5% (ripple P-P: \leq 5%) model
Current consumption	≤ 60 mA (no load)
Insulation resistance	Between all terminals and case: \geq 100 M Ω (500 VDC \equiv megger)
Dielectric strength	Between all terminals and case: 750 VAC \sim 50 / 60 Hz for 1 minute
Vibration	1 mm double amplitude at frequency 10 to 55 Hz (for 1 minute) in each X, Y, Z direction for 2 hours
Shock	\leq 75 G
Ambient temp.	-10 to 70 °C, storage: -25 to 85 °C (no freezing or condensation)
Ambient humi.	35 to 85%RH, storage: 35 to 90%RH (no freezing or condensation)
Protection rating	IP50 (IEC standard)
Connection	Axial (cable gland)
Cable spec.	\varnothing 6 mm, 17-wire, 2 m, shield cable
Wire spec.	AWG28 (0.08 mm, 17-core), insulator diameter: \varnothing 0.8 mm

50 mm Wire-Type Linear Scale Absolute Encoders (Optical)

EWLS50 Series



Features

- Resolution: 0.1 mm
- Maximum measurement range: 512 mm
- Various output code options:
Binary, Gray code

Specifications

Model	EWLS50-512-B-PN-24	EWLS50-512-G-PN-24
Measuring range	512 mm	
Max. output pulse	5,120 division / 512 mm	
Min. resolution	0.1 mm	
Accuracy	± 0.1 / 100 mm	
Response speed	≤ 500 mm / sec	
Wire movement limit when power is OFF ⁰¹⁾	≤ ± 20 mm	
Output code	Binary	Gray
Output signal	Data, Overflow alarm (OVF)	
Control output	Parallel NPN open collector output	
Inflow current	≤ 32 mA	
Residual voltage	≤ 1 VDC≐	
Output logic	Negative logic output	
Response speed ⁰²⁾	≤ 1 μs	
Input signal	Reset signal input (Reset)	
Input level	H: 5 - 24 VDC≐, L: 0 - 1.2 VDC≐	
Input logic	Low Active, OPEN or HIGH for common use	
Input time	≥ 100 ms	
Max. response freq.	50 kHz	
Wire tensile force	0.5 to 4 N (50 to 400 g-f)	
Unit weight	≈ 450 g	
Approval	CE EAC	

01) The product cannot process data when the power is OFF. It calibrates the data comparing values of before and after power ON status. It shall be used on the condition that wire movement limit because proper data may not be available if any wire movement occurred over ±20mm from the position when power is off.

02) Based on cable length: 2 m, I sink = 32 mA

Power supply	12 - 24 VDC≐ ± 5% (ripple P-P: ≤ 5%)
Current consumption	≤ 150 mA (no load)
Insulation resistance	≥ 100 MΩ (500 VDC≐ megger)
Dielectric strength	750 VAC~ 50 / 60 Hz for 1 minute
Vibration	1 mm double amplitude at frequency 10 to 55 Hz (for 1 minute) in each X, Y, Z direction for 2 hours
Shock	≤ 50 G
Ambient temp.	-10 to 70 °C, storage: -25 to 85 °C (no freezing or condensation)
Ambient humi.	35 to 85%RH, storage: 35 to 90%RH (no freezing or condensation)
Connection	Axial cable type (cable gland)
Cable spec.	Ø 6 mm, 17-wire, 2 m, shield cable
Wire spec.	AWG28 (0.08 mm, 19-core), insulator diameter: Ø 0.8 mm
Material	Cap: SPCD, Body: A2024, Wire: SUS303

50 mm Diameter Absolute Multi-Turn Rotary Encoders (Optical)

EPM50 Series



Features

- Ø 50 mm housing, Ø 8 mm solid shaft multi-turn absolute rotary encoders
- Output interface options:
Parallel, SSI (Synchronous Serial Interface)
- 23-bit (8,388,608) total resolution
 - 10-bit single-turn (1,024 divisions)
 - 13-bit multi-turn (8,192 revolutions)
- Zero-point reset with single-turn data reset and multi-turn count reset functions
- Position memory backup
- CW / CCW direction setting function
- Overflow alarm (OVF) function
- Latch function (Parallel output type only)
- IP64 protection structure (IEC standard)

Specifications

Model	EPM50S8-1013-B-PN-24-□	EPM50S8-1013-B-S-24-□
Resolution	• Single-turn: 1024 division, 10 bit • Multi-turn: 8192 revolution, 13 bit	
Rotation limit when power OFF ⁰¹⁾	± 90°	
Output code	Binary 2 code	24 bit, Binary 2 code
Output signal	Single-turn data, Multi-turn count, Overflow alarm (OVF) ⁰²⁾	
Control output	Parallel NPN open collector output	SSI (Synchronous Serial Interface) Line driver output
Inflow current	≤ 32 mA	≤ 20 mA
Residual voltage	≤ 1 VDC≐	≤ 0.5 VDC≐
Outflow current	-	≤ -20 mA
Output voltage	-	≥ 2.5 VDC≐
Output logic	Negative logic output	-
Response speed ⁰³⁾	≤ 1 μs	-
Single-turn data reset ⁰⁴⁾ Multi-turn count reset ⁰⁵⁾ Direction Clear	Input level: 0 ~ 1 VDC≐ Input logic: Low Active, OPEN or HIGH in common use Input time: ≥ 100 ms	
Latch	Input level: 0 ~ 1 VDC≐ Input logic: Low Active, OPEN or HIGH in common use Input time: ≥ 500 μs	-
Clock	-	Input level: 5 VDC≐ ± 5% Input frequency: 100 kHz to 1 MHz
Max. response freq.	50 kHz	-
Max. allowable revolution ⁰⁶⁾	3,000 rpm	-
Starting torque	≤ 0.0069 N m	
Inertia moment	≤ 40 g·cm ² (4 × 10 ⁻⁶ kg·m ²)	
Allowable shaft load	Radial: 10 kgf, Thrust: 2.5 kgf	
Unit weight (packaged)	≈ 475 g (≈ 560 g)	≈ 324 g (≈ 409 g)
Approval	CE ENEC	

01) It calibrates the multi-turn count by comparing single-turn data before/after power off without counting multi-turn count when power off. Correct multi-turn count cannot be obtained if a rotating operation exceeding ± 90° is performed at the rotation position when power off.

02) Outputs when multi-turn count is out of counting range (0 to 8191 revolution).

03) Based on cable length: 2 m, I sink = 32 mA

04) If the single-turn data reset signal is applied, the single-turn data will be initialized to 0.

05) If the multi-turn count reset signal is applied, the multi-turn count will be initialized to 0.

06) For parallel model Select resolution to satisfy Max. allowable revolution ≥ Max. response revolution

$$[\text{max. response revolution (rpm)}] = \frac{\text{max. response frequency} \times 60 \text{ sec}}{\text{resolution}}$$

Power supply	12 - 24 VDC≐ ± 5% (ripple P-P: ≤ 5%)
Current consumption	Parallel NPN open collector output: ≤ 100 mA (no load) SSI Line driver output: ≤ 150 mA (no load)
Insulation resistance	Between all terminals and case: ≥ 100 MΩ (500 VDC≐ megger)
Dielectric strength	Between all terminals and case: 750 VAC~ 50 / 60 Hz for 1 minute
Vibration	1 mm double amplitude at frequency 10 to 55 Hz (for 1 minute) in each X, Y, Z direction for 2 hours
Shock	≤ 50 G
Ambient temp.	-10 to 70 °C, storage: -25 to 85 °C (no freezing or condensation)
Ambient humi.	35 to 85%RH, storage: 35 to 90%RH (no freezing or condensation)
Protection rating	Axial cable type: IP64 (IEC standard), Radial cable type: IP50 (IEC standard)
Connection	Axial / Radial cable type model (cable gland)
Cable spec.	Ø 6 mm, 2 m, shield cable Parallel NPN open collector output: 17-wire × 2, SSI Line driver output: 10-wire
Wire spec.	AWG28 (0.08 mm), insulator diameter: Ø 0.8 mm Parallel NPN open collector output: 17-core, SSI Line driver output: 19-core

50 mm Diameter Absolute Multi-Turn Rotary Encoders (Magnetic)

MGAM50 Series



Features

- High accuracy in harsh environments including shock, vibration, dust, and humidity (compared to optical encoders)
- Longer service life compared to optical encoders
- Output code: binary
- Output interface options: Parallel, SSI (Synchronous Serial Interface)
- 23-bit (8,388,608) total resolution
 - 10-bit single-turn (1024 divisions)
 - 13-bit multi-turn (8192 revolutions)
- Power supply: 12 - 24 VDC \pm 5%
- Overflow alarm (OVF) function
- IP50 protection structure (IEC standard)

Specifications

Model	MGAM50S8-1013-B-F-PN-24	MGAM50S8-1013-B-F-S-24
Resolution	• Single-turn: 1024 division • Multi-turn: 8192 revolution	
Rotation limit when power OFF ⁰¹⁾	$\pm 90^\circ$	
Hysteresis	$\pm 0.1^\circ$	
Positioning error ⁰²⁾	± 1 bit (LSB: Least Significant Bit)	
Output code	Binary 2 code	24 bit, Binary 2 code
Output signal	Single-turn data, Multi-turn count, Overflow alarm (OVF) ⁰³⁾	
Control output	Parallel NPN open collector output	SSI (Synchronous Serial Interface) Line driver output
Inflow current	≤ 20 mA	≤ 20 mA
Residual voltage	≤ 1 VDC \approx	≤ 0.5 VDC \approx
Outflow current	-	≤ -20 mA
Output voltage	-	≥ 2.5 VDC \approx
Output logic	Negative logic output	-
Response speed ⁰⁴⁾	≤ 1 μ s	-
Multi-turn count reset	Input level: 0 - 1 VDC \approx Input logic: Low Active, Open for common use Input time: ≥ 100 ms	
Clock	-	Input level: 5 VDC \approx $\pm 5\%$ Input frequency: 100 kHz to 1 MHz
Max. response freq.	30 kHz	-
Max. allowable revolution ⁰⁵⁾	3,000 rpm	
Starting torque	≤ 0.0069 N m	
Inertia moment	≤ 80 g \cdot cm ² (8×10^{-6} kg \cdot m ²)	
Allowable shaft load	Radial: 10 kgf, Thrust: 2.5 kgf	
Unit weight (packaged)	≈ 393 g (≈ 523 g)	≈ 261 g (≈ 391 g)
Approval	CC	

01) It calibrates the multi-turn count by comparing single-turn data before/after power off without counting multi-turn count when power off. Correct multi-turn count cannot be obtained if a rotating operation exceeding $\pm 90^\circ$ is performed at the rotation position when power off. Use within the condition of rated rotating operation.

02) When power ON / OFF the unit, ± 1 bit (LSB) can be changed at current position due to hysteresis.

03) Outputs when multi-turn count is out of counting range (0 to 8191 revolution).

04) Based on cable length: 2 m, I sink = 20 mA

05) For parallel model Select resolution to satisfy Max. allowable revolution \geq Max. response revolution

$$[\text{max. response revolution (rpm)}] = \frac{\text{max. response frequency}}{\text{resolution}} \times 60 \text{ sec}$$

Power supply	12 - 24 VDC \approx $\pm 5\%$ (ripple P-P: $\leq 5\%$)
Current consumption	Parallel NPN open collector output ≤ 100 mA (no load) SSI Line driver output ≤ 150 mA (no load)
Insulation resistance	Between all terminals and case: ≥ 100 M Ω (500 VDC \approx megger)
Dielectric strength	Between all terminals and case: 750 VAC $\sim 50 / 60$ Hz for 1 minute
Vibration	1 mm double amplitude at frequency 10 to 55 Hz (for 1 minute) in each X, Y, Z direction for 2 hours
Shock	≤ 50 G
Ambient temp.	-10 to 70 $^\circ$ C, storage: -25 to 85 $^\circ$ C (no freezing or condensation)
Ambient humi.	35 to 85%RH, storage: 35 to 90%RH (no freezing or condensation)
Protection rating	IP50 (IEC standard)
Connection	Axial cable type (cable gland)
Cable spec.	$\varnothing 6$ mm, 2 m, shield cable Parallel NPN open collector output: 17-wire $\times 2$, SSI Line driver output: 10-wire
Wire spec.	AWG28 (0.08 mm), insulator diameter: $\varnothing 0.8$ mm Parallel NPN open collector output: 17-core, SSI Line driver output: 19-core

Manual Handle Type Pulse Generators

ENH Series



Features

- Ideal for manual pulse input applications including NC machinery and milling machines
- Terminal connection type
- Resolutions: 25, 100 pulses per revolution
- Power supply:
5 VDC \pm 5%, 12 - 24 VDC \pm 5%

Specifications

Model	ENH-□-□-T-□	ENH-□-□-V-□	ENH-□-□-L-5
Resolution	25 / 100 PPR model		
Control output	Totem pole output	Voltage output	Line driver output
Output phase	A, B	A, B	A, B, \bar{A} , \bar{B}
Inflow current	≤ 30 mA	-	≤ 20 mA
Residual voltage	≤ 0.4 VDC \equiv	≤ 0.4 VDC \equiv	≤ 0.5 VDC \equiv
Outflow current	≤ 10 mA	≤ 10 mA	≤ -20 mA
Output voltage (5 VDC\equiv)	\geq (power supply -2.0) VDC \equiv	-	≥ 2.5 VDC \equiv
Output voltage (12 - 24 VDC\equiv)	\geq (power supply -3.0) VDC \equiv	-	-
Response speed ⁰¹⁾	≤ 1 μ s	≤ 1 μ s	≤ 0.2 μ s
Max. response freq.	10 kHz		
Max. allowable revolution ⁰²⁾	Normal: ≤ 200 rpm, Peak: ≤ 600 rpm		
Starting torque	≤ 0.098 N m		
Allowable shaft load	Radial: ≤ 2 kgf, Thrust: ≤ 1 kgf		
Unit weight (packaged)	≈ 260 g (≈ 330 g)		
Approval	CE EAC	CE EAC	EAC

01) Based on cable length: 1 m, I sink: 20 mA

02) Select resolution to satisfy Max. allowable revolution \geq Max. response revolution

$$[\text{max. response revolution (rpm)}] = \frac{\text{max. response frequency}}{\text{resolution}} \times 60 \text{ sec}$$

Model	ENH-□-□-T-□	ENH-□-□-V-□	ENH-□-□-L-5
Power supply	5 VDC \pm 5% (ripple P-P: $\leq 5\%$) / 12 - 24 VDC \pm 5% (ripple P-P: $\leq 5\%$) model		5 VDC \pm 5% (ripple P-P: $\leq 5\%$)
Current consumption	≤ 40 mA (no load)		≤ 50 mA (no load)
Insulation resistance	Between all terminals and case: ≥ 100 M Ω (500 VDC \equiv megger)		
Dielectric strength	Between all terminals and case: 750 VAC \sim 50 / 60 Hz for 1 minute		
Vibration	1 mm double amplitude at frequency 10 to 55 Hz (for 1 minute) in each X, Y, Z direction for 2 hours		
Shock	≤ 50 G		
Ambient temp.	-10 to 70 °C, storage: -25 to 85 °C (no freezing or condensation)		
Ambient humi.	35 to 85%RH, storage: 35 to 90%RH (no freezing or condensation)		
Protection rating	IP50 (IEC standard)		
Connection	Terminal block type		

Portable Manual Handle Type Pulse Generators

ENHP Series



Features

- Ideal for manual pulse input applications including NC machinery and milling machines
- Emergency stop switch, enable operation switch
- 6-position axis selector switch, 4-position rate selector switch
- Resolution: 100 pulses per revolution
- Power supply:
5 VDC \pm 5%, 12 - 24 VDC \pm 5%

Specifications

Model	ENHP-100-□-T-□	ENHP-100-□-L-5
Resolution	100 PPR	
Control output	Totem pole output	Line driver output
Output phase	A, B	A, \bar{A} , B, \bar{B}
Rotary switch output	BCD code: Rate select switch (R1, R2, R3, R4) Axis select switch (OFF, X, Y, Z, A, B)	
Inflow current	\leq 30 mA	\leq 20 mA
Residual voltage	\leq 0.4 VDC \pm	\leq 0.5 VDC \pm
Outflow current	\leq 10 mA	\leq -20 mA
Output voltage (5 VDC \pm)	\geq (power supply -2.0) VDC \pm	\geq 2.5 VDC \pm
Output voltage (12 - 24 VDC \pm)	\geq (power supply -3.0) VDC \pm	-
Response speed ⁰¹⁾	\leq 1 μ s	\leq 0.5 μ s
Max. response freq.	10 kHz	
Max. allowable revolution ⁰²⁾	Normal: \leq 200 rpm, Peak: \leq 600 rpm	
Starting torque	\leq 0.098 N m	
Allowable shaft load	Radial: \leq 2 kgf, Thrust: \leq 1 kgf	
Unit weight	\approx 730 g	
Approval	CE ENEC	ENEC

01) Based on cable length: 1 m, I sink: 20 mA

02) Select resolution to satisfy Max. allowable revolution \geq Max. response revolution

$$[\text{max. response revolution (rpm)}] = \frac{\text{max. response frequency}}{\text{resolution}} \times 60 \text{ sec}$$

Model	ENHP-100-□-T-□	ENHP-100-□-L-5
Power supply	5 VDC \pm 5% (ripple P-P: \leq 5%) / 12 - 24 VDC \pm 5% (ripple P-P: \leq 5%) model	5 VDC \pm 5% (ripple P-P: \leq 5%)
Current consumption	\leq 40 mA (no load)	\leq 50 mA (no load)
Insulation resistance	Between all terminals and case: \geq 100 M Ω (500 VDC \pm megger)	
Dielectric strength	Between all terminals and case: 750 VAC \sim 50 / 60 Hz for 1 minute	
Vibration	1 mm double amplitude at frequency 10 to 55 Hz (for 1 minute) in each X, Y, Z direction for 2 hours	
Shock	\leq 50 G	
Ambient temp.	-10 to 70 $^{\circ}$ C, storage: -25 to 85 $^{\circ}$ C (no freezing or condensation)	
Ambient humi.	35 to 85%RH, storage: 35 to 90%RH (no freezing or condensation)	
Protection rating ⁰¹⁾	IP67 (IEC standard)	
Connection	connector type	
Cable spec.	\varnothing 5 mm, 18-wire, 8 m, spring code cable	
Wire spec.	AWG28 (0.08 mm, 18-core), insulator diameter: \varnothing 0.7 mm	
Connector spec.	25-pin D-SUB	

01) It is protection for the back case and the wiring part.

Flexible Shaft Coupling

ERB Series



Features

- Zero backlash
- High-strength aluminum alloy (AL7075-T6), High elasticity
- Alumite treated surface provides high corrosion resistance
- 2 connection types (clamp type, screw type)

Specifications

Model	ERB-A-19C-□	ERB-A-19S-□	ERB-A-26C-□	ERB-A-26S-□
Connection type	Clamp	Set screw	Clamp	Set screw
Max. revolution	8,000 rpm	20,000 rpm	6,000 rpm	15,000 rpm
Max. torque	1.2 N m		3.0 N m	
Rated torque	0.6 N m		1.5 N m	
Mounting bolt (mounting torque)	M2.5 (1 N m)	M3 (0.7 N m)	M3 (0.7 N m)	M4 (1.7 N m)
Torsional stiffness	140 N m / rad		240 N m / rad	
Inertia moment	$6.4 \times 10^{-7} \text{ kg}\cdot\text{m}^2$		$3.4 \times 10^{-6} \text{ kg}\cdot\text{m}^2$	
Max. allowable misalignment	Angular misalignment: $\leq 2.5^\circ$ Parallel misalignment: $\leq 0.15 \text{ mm}$ End-play: $\leq \pm 0.3 \text{ mm}$		Angular misalignment: $\leq 2.5^\circ$ Parallel misalignment: $\leq 0.2 \text{ mm}$ End-play: $\leq \pm 0.4 \text{ mm}$	
Standard bore diameter (tolerance h7)	$\varnothing 4, \varnothing 5, \varnothing 6 \text{ mm}$		$\varnothing 6, \varnothing 8 \text{ mm}$	
Max. allowable diameter	$\varnothing 4 \text{ to } 8 \text{ mm}$		$\varnothing 5 \text{ to } 12 \text{ mm}$	
Material	Aluminum (AL 7075-T6), Alumite surface			
Unit weight (packaged)	$\approx 14.4 \text{ g} (\approx 14.9 \text{ g})$		$\approx 36.7 \text{ g} (\approx 37.3 \text{ g})$	

B. Field Instruments

Field instruments including pressure and temperature transmitters measure and transmit important data in industrial applications and other diverse settings.

B1. Temperature Sensors

B2. Temperature Transmitters

B3. Pressure Sensors





B



B1. Temperature Sensors

Temperature sensors are used to measure temperature of gases or liquids using thermocouples and thermoresistors.

B1-1

Temperature / Humidity Transducers

THD Series

Temperature / Humidity Sensors

Temperature / Humidity Sensors

THD Series



Features

- Compact design
- Built-in high accuracy temperature / humidity sensor
- 7 segment LED display (THD-DD / THD-WD)
- Various output options: DC4 - 20 mA, 1 - 5 VDC, RS485 (Modbus RTU)
- Wide measurable range of temperature / humidity: -19.9 to 60.0 °C / 0.0 to 99.9 %RH
- Communication speed: 115200 bps

Specifications

Model	THD-R-PT			
Sensor type	Temperature sensor			
Display type	Non-display type			
Temp. measuring range	-19.9 to 60.0 °C			
Temp. accuracy	≤ ±0.8 °C			
Temp. output	DPT100Ω resistance value (TCR: 3850 ppm/°C)			
Protection structure	IP10 (IEC standards)			
Ambient temperature	-20 to 60 °C, Storage: -20 to 60 °C (rated at no freezing or condensation)			
Approval	CE ENEC			
Model	THD-R-PT/C	THD-R-C THD-R-V THD-R-T	THD-D□-□ THD-W□-□	THD-DD□-□ THD-WD□-□
Power supply	24 VDC ±10 %			
Power consumption	≤ 2.4W			
Sensor type	Temperature/Humidity Sensor			
Sensor response time	10 sec			
Display type	Non-display type			7 seg. LED display
Display digit	-			Each 3 digits for temp. / humi.
Temp. measuring range	-19.9 to 60.0 °C			
Humi. measuring range	0.0 to 99.9 %RH (THD-R is required to attend for using over 90 %RH)			
Temp. accuracy	± 1.0 °C (at room temp.)			
Humi. accuracy	± 3 %RH (30 to 70 %RH, at room temp.) ± 4 %RH (10 to 90 %RH)		Typ. ±2 %RH (10 to 90 %RH, at room temp.) ≤ ± 2.5 %RH	
Temp. output	DPT100Ω resistance value (TCR: 3850 ppm/°C)		DC 4-20 mA (allowable impedance: ≤ 600 Ω), 1-5 VDC, RS485 Communication (Modbus RTU)	
Humi. output	DC 4-20 mA (allowable impedance: ≤ 600 Ω)			
Resolution	1/1000			
Sampling period	0.5 sec			
Insulation resistance	≥ 100 MΩ (500 VDC megger)			
Dielectric strength	500 VAC ~ 50/60 Hz for 1 min			
Noise immunity	±0.3 kV the square wave noise (pulse width: 1 μs) by the noise simulator			
Vibration	0.75 mm amplitude at frequency of 10 to 55 Hz (for 1 min) in each X, Y, Z direction for 1 hour			
Vibration (Malfunction)	0.5 mm amplitude at frequency of 10 to 55Hz (for 1 min) in each X, Y, Z direction for 1 hour			
Shock	300 m/s ² (≈ 30 G) in each X, Y, Z direction for 3 times			
Shock (Malfunction)	100 m/s ² (≈ 10 G) in each X, Y, Z direction for 3 times			
Protection structure	IP10 (IEC standards)		IP65 (except sensor part, IEC standards)	
Ambient temperature	-20 to 60 °C, Storage: -20 to 60 °C (rated at no freezing or condensation)			
Cable spec.	-		Ø4 mm, 4-wire, length: 2 m	
Wire spec.	-		AWG22 (0.08 mm, 60-wire), Insulator diameter: Ø1.25 mm	
Approval	CE (only for THD-□-T model) ENEC			
Comm. protocol	Modbus RTU			



B

B2. Temperature Transmitters

Temperature transmitters measure temperature value from temperatures sensors (thermocouples, RTD, etc) and transmits the data in voltage or current.

B2-1 Temperature Transmitters

KT-502H Series

HART Protocol Transmitters

CN-502H Series

HART Protocol Cylindrical Temperature Transmitters

HART Protocol Transmitters

KT-502H Series



Features

- HART protocol
- 330 ° rotatable display for environment conditions
- Increased visibility with backlight function
- Multi-input (order 1 input type among 22 types)
 - RTD 8 types
 - Thermocouple 8 types
 - mV 4 types
 - Resistor 2 types
- Explosion class: Ex d IIC T6
- Protection structure: IP67 (IEC standard)

Specifications

Model	KT-502H
Power supply	10.5-45 VDC≐ (with backlight LCD)
Output	DC 4-20 mA (2-wire)
Input specifications	Refer to 'Input Specifications'
Accuracy	± 0.3 %
Display method	PV display part: 7 segment 5 digit (character size: W4×H8 mm), Parameter display part: 14 segment 8 digit (character size: W2.6×H4.8 mm), 52 bar meter
Display range	-19,999 to 99,999
Setting method	HART-protocol (no setting key)
Response time	1 sec
Alarm	≤ 3.8 mA, > 20.5 mA / Sensor break 3.6 mA
Load	≤ (V power supply - 7.5 V) / 0.22 A
Galvanic insulation	2 kVAC~ (Input/Output)
Unit weight (Packaged)	≈ 1.2 kg (≈ 1.4 kg)
Ambient temp.	-20 to 70 °C, Storage: 20 to 80 °C (rated at no freezing or condensation)
Ambient humi.	0 to 85 %RH, Storage: 0 to 85 %RH (rated at no freezing or condensation)
Protection structure	IP67 (IEC standard)
Material	Body: Aluminum (AlDc.8S), Cover O-Ring: Buna N
Explosion class ⁰¹⁾	Ex d IIC T6
Approval	CE ENEC ATEX

01) The explosion class specification is acquired and managed by KONICS.

Input Specifications

Input type		Input range (°C)	Input range (°F)
Thermocouple	K (NiCr-Ni)	-270 to 1,372	-454 to 2,501.6
	J (Fe-CuNi)	-210 to 1,200	-346 to 2,192
	E (NiCr-CuNi)	-270 to 1,000	-454 to 1,832
	T (Cu-CuNi)	-270 to 400	-454 to 752
	B (PtRh30-PtRh6)	0 to 1,820	32 to 3,308
	R (PtRh13-Pt)	-50 to 1,768	-58 to 3,214.4
	S (PtRh10-Pt)	-50 to 1,768	-58 to 3,214.4
	N (NiCrSi-NiSi)	-270 to 1,300	-454 to 2,372
RTD	Cu50 Ω	-50 to 150	-58 to 302
	Cu100 Ω	-50 to 150	-58 to 302
	DPt100 Ω	-200 to 850	-328 to 1,562
	DPt500 Ω	-200 to 250	-328 to 482
	DPt1000 Ω	-200 to 250	-328 to 482
	Ni100 Ω	-60 to 180	-76 to 356
	Ni500 Ω	-60 to 180	-76 to 356
	Ni1000 Ω	-60 to 150	-76 to 302
Resistance transmitter	Resistance (Ω)	0 to 400 Ω	-
		0 to 2000 Ω	-
Analog	Voltage	-10 - 75 mV	-
		-100 - 100 mV	-
		-100 - 500 mV	-
		-100 - 2,000 mV	-

HART Protocol Cylindrical Temperature Transmitters

CN-502H Series



Features

- HART protocol
- Multi-input
 - RTD 8 types
 - Thermocouple 7 types
 - mV 4 types
 - Resistor 2 types
- Small size: $\varnothing 44 \times 24$ H
- High accuracy: $\pm 0.3\%$ F.S.

Specifications

Model	CN-502H
Power supply	11-35 VDC=
Power consumption	≤ 1 W
Display method ⁰¹⁾	No mark
Measurable current	50 μ A (3-wire), 100 μ A (4-wire)
Resistance	$\leq 5 \Omega$
Input specification	Refer to 'Input Specifications'
Input accuracy	$\pm 0.1\%$ F.S.
Output	DC 4-20 mA (2-wire)
Output accuracy	$\pm 0.1\%$ F.S.
Response time	1 sec (10 to 90 % of output)
Load	\leq (Power supply-11 VDC=) / 0.023 A
Setting method	HART-protocol (no setting key)
Alarm	≤ 3.8 mA, > 21.0 mA, sensor break 22 mA or 3.6 mA
Sampling period	500 ms
Unit weight (Packaged)	≈ 26 g (≈ 66 g)
01) Parameter setting and state monitoring are available through an external device such as HART communicator or loader.	
Dielectric strength	1000 VAC \sim 50/60 Hz 1 min (between all terminals and case)
Noise immunity	IEC 61326-1
Vibration	0.75 mm amplitude a frequency of 5 to 55 Hz (for 1 min) in each X, Y, Z direction for 2 hours
Insulation resistance	≥ 100 M Ω (500VDC= megger)
Memory protection	≈ 10 years (when using non-volatile semiconductor memory)
Tightening torque	Housing: 1 N m, Terminal: 0.9 N m
Galvanic insulation	1 kVAC \sim (Input/Output)
Ambient temperature	-40 to 85 $^{\circ}$ C, Storage: -40 to 85 $^{\circ}$ C (rated at no freezing or condensation)
Ambient humidity	5 to 95 %RH, Storage: 5 to 95 %RH (rated at no freezing or condensation)
Protection structure	Housing: IP40 (IEC standard), Terminal: IP00 (IEC standard)
Material	Case: PC
Approval	CE 



B

B3. Pressure Sensors

Pressure sensors are devices used in a variety of applications requiring precise and accurate pressure measurement of gases or liquids.

B4-1	Digital Display	PSQ Series	Dual Display Type Pressure Sensors
		PSAN Series	Display Type Pressure Sensors
		PSB Series	Display Type Pressure Sensors
B4-2	Non-Indicating	PSS Series	Compact Pressure Sensors
B4-3	Pressure Sensor Indicators	PSM Series	Pressure Sensor Indicators

Dual Display Type Pressure Sensors

PSQ Series



Features

- Pressure measurement of any gas, liquid or oil [fluid type] except substances which may corrode stainless steel 316L
- Dual display for simultaneous display of process value (PV) and setpoint value (SV)
- Secondary (SV) display: setpoint value, pressure unit, or display-OFF
- Switch between NPN and PNP open collector output via parameter configuration
- 3-color main (PV) display (RUN mode: green / red, parameter setting mode: orange)
- 12-segment LCD display capable of diverse alphanumeric characters
- Measurement range: -100.0 to 100.0 kPa / -100 to 1000 kPa
(Pneumatic type : compound pressure, Fluid type : sealed gauge pressure)
- Analog output: voltage (1 - 5 VDC \equiv), current (DC 4 - 20 mA)
- Copy parameter settings function
- External input: Auto-Shift, Remote, Hold (PSQ-□□□□U-□ models only)
- Forced output control mode for device testing and inspection
- Display resolution: 0.1 kPa / 1 kPa (by model)
- One-touch connector type for easy wiring and maintenance
- Password lock for parameter configuration settings

Specifications

Model	PSQ-C□□□□	PSQ-BC□□□□
Applicable medium	Pneumatic type (air, non-corrosive gas)	Fluid type (non-corrosive gas and fluid that do not corrode stainless steel 316L) Sealed gauge pressure ⁰¹⁾
Pressure type	Gauge pressure	
Rated pressure range	-100.0 to 100.0 kPa / -100 to 1,000 kPa model	
Display and setting pressure range	<ul style="list-style-type: none"> • Rated pressure range -100.0 to 100.0 kPa model: -101.3 to 110.0 kPa • Rated pressure range -100 to 1,000 kPa model: -101 to 1,100 kPa 	
Display type	PV / SV display part: 12 segment LCD, 4digit	
Display accuracy	-10 to 0 °C: $\leq \pm 1\%$ F.S., 0 to 50 °C: $\leq \pm 0.5\%$ F.S.	
Min. display unit	<ul style="list-style-type: none"> • Rated pressure range -100.0 to 100.0 kPa model: 0.1 kPa • Rated pressure range -100 to 1,000 kPa model: 1 kPa 	
Min. display interval	Different by pressure unit ⁰²⁾	
Max. pressure range	<ul style="list-style-type: none"> • Rated pressure range -100.0 to 100.0 kPa model: Rated pressure $\times 2$ • Rated pressure range -100 to 1,000 kPa model: Rated pressure $\times 1.5$ 	Rated pressure $\times 3$
Connection	Connector type	Cable type
Cable	\varnothing 4 mm, 5 core, 2 m	\varnothing 4 mm, 5 core, 3 m
Wire	AWG 24 (0.08 mm, 40 seam) insulator diameter: \varnothing 1 mm	
Material	Front case: PC, back case: PBT+G15%, pressure port: SUS303	Front case: PC, back case: PA6, pressure port: SUS316L
Protection structure	IP40 (IEC standard)	
Approval	CE  ENEC	
Unit weight (packaged)	\approx 80 g (\approx 165 g)	\approx 125 g (\approx 210 g)
<small>01) The unit is sealed structure. It is based on atmospheric pressure 101.3kPa. 02) Refer to 'minimum display interval per pressure unit'.</small>		
Power supply	12 - 24 VDC \equiv (ripple P-P: $\leq 10\%$)	
Allowable voltage range	90 to 110% of rated voltage	
Current consumption	≤ 50 mA (analog output model: ≤ 70 mA)	
Control output	NPN or PNP open collector output	
Load voltage	≤ 30 VDC \equiv	
Load current	≤ 100 mA	
Residual voltage	≤ 2 VDC \equiv	
Hysteresis	Different by output operation mode (parameter) ⁰¹⁾	
Repeat error	$\pm 0.2\%$ F.S. \pm min. display interval	
Response time	2.5 to 5,000 ms (parameter)	
Protection circuit	Output short over current protection circuit	
Insulation resistance	≥ 50 M Ω (500 VDC \equiv megger)	
Dielectric strength	1,000 VAC \sim 50 / 60 Hz for 1 min	
Vibration	1.5mm amplitude at frequency of 10 to 55Hz (for 1min) in each X, Y, Z direction for 2 hours	
Ambient temperature	-10 to 50 °C, storage: -20 to 60 °C (no freezing or condensation)	
Ambient humidity	30 to 80%RH, storage: 30 to 80%RH (no freezing or condensation)	
<small>01) Refer to 'Output operation mode'.</small>		
External input	Auto shift - Remote zero - Hold (parameter)	
ON / OFF voltage input	ON voltage: ≤ 0.4 VDC \equiv , OFF voltage: 5-Vin or open, input impedance: ≈ 100 k Ω	
Resolution	1 / 2,000	
Option output	Analog voltage - Analog current output (parameter)	
Analog voltage output	1 - 5 VDC \equiv $\pm 2.5\%$ F.S., output impedance: ≈ 240 Ω	
Analog current output	DC4 - 20 mA $\pm 2.5\%$ F.S., output impedance: ≈ 100 k Ω	
Linearity	$\leq \pm 1\%$ F.S.	
Resolution	1 / 2,000	
Response time	50 ms	

Display Type

Pressure Sensors

PSAN Series



Features

- Pressure measurement of any gas, liquid or oil (except substances which may corrode stainless steel 304 / 316L)
- Auto shift function: with change in the original pressure, the external input adjusts the determined level to match the change in pressure (only available in models with auto shift / hold function)
- Hold function: hold current display value or control output
- Forced output control mode for device testing and maintenance
- One-touch connector type for easy wiring and maintenance
- Zero-point adjustment function, peak value monitoring function, chattering prevention function

Specifications

Model	PSAN- □V01C□□-□	PSAN- □01C□□-□	PSAN- □1□□□-□	PSAN- □C01□□□-□
Pressure Type	Pneumatic type model: Gauge pressure Fluid type model: Gauge pressure ⁰¹⁾ or sealed gauge pressure ⁰²⁾			
Pressure	Negative	Static		Compound
Min display unit	0.1 kPa	0.1 kPa	1 kPa	0.1 kPa
Rated pressure range	0.0 to -101.3 kPa	0.0 to 100.0 kPa	0 to 1,000 kPa	-101.3 to 100.0 kPa
Display & setting pressure range	5.0 to -101.3 kPa	-5.0 to 110.0 kPa	-101.3 to 1,100 kPa	-101.3 to 110.0 kPa
Display type	7 Segment LED, 4 ½ digit			
Display accuracy	-10 to 0 °C: ≤ ±1% F.S., 0 to 50 °C: ≤ ±0.5% F.S.			
Max. pressure	Rated pressure × 2	Rated pressure × 2	• Pneumatic type: Rated pressure × 1.5 • Fluid type: Rated pressure × 2	Rated pressure × 2

01) Only for static pressure, rated pressure range 100.0 kPa model

02) The unit is sealed structure. It is based on atmospheric pressure 101.3 kPa.

Applicable medium	Pneumatic type (air, non-corrosive gas)	Fluid type (non-corrosive gas and fluid that do not corrode stainless steel 316L)
Connection type	Connector type	Cable type / connector type
Cable	∅ 4 mm, 5-core, 2 m	Connector type: ∅ 4 mm, 5-core, 2 m Cable type: ∅ 4 mm, 5-core, 3 m
Wire spec.	AWG24 (0.08 mm, 40-core), insulator diameter: ∅ 1 mm	
Material	Front case: PC Back case: (back port) PC / (bottom port) PBT+GF15% Pressure port: Brass-nickel plated	Front case: PC Back case: PA6 Pressure port: SUS304/SUS316L
Protection structure	Connector type: IP40 (IEC standard)	Connector type: IP40 (IEC standard) Cable type: IP65 (IEC standard)
Approval	CE ENEC	
Unit weight (packaged)	Back port: ≈ 80 g (≈ 165 g) Bottom port: ≈ 85 g (≈ 170 g)	Connector type: ≈ 88 g (≈ 173 g) Cable type: ≈ 90 g (≈ 167 g)

Next Page ►

Power supply	12 - 24 VDC \equiv (ripple P-P: \leq 10%)
Allowable voltage range	90 to 110% of rated voltage
Current consumption	\leq 50 mA ⁰¹⁾
Control output	NPN open collector output / PNP open collector output model
Load voltage	\leq 30 VDC \equiv
Load current	\leq 100 mA
Residual voltage	NPN: \leq 1 VDC \equiv , PNP: \leq 2 VDC \equiv
Hysteresis	According to output operation mode ⁰²⁾
Repeat error	\pm 0.2% F.S. \pm min display interval
Response time	2.5, 5, 100, 500, 1000 ms
Protection circuit	Output short over-current protection circuit
Insulation resistance	\geq 50 M Ω (500 VDC \equiv megger)
Dielectric strength	1,000 VAC \sim 50 / 60 Hz for 1 min
Vibration	1.5 mm amplitude at frequency of 10 to 55Hz (for 1 min) in each X, Y, Z direction for 2 hours
Ambient temperature	-10 to 50 °C, Storage: -20 to 60 °C (no freezing or condensation)
Ambient humidity	30 to 80%RH, Storage: 30 to 80%RH (no freezing or condensation)

01) Current output: \leq 75 mA02) Refer to 'Output operation mode'. \pm 1digit error may occur due to pressure unit operation.

Analog output	Voltage (1 - 5 VDC\equiv \pm2% F.S)	Current (DC 4 - 20mA \pm2% F.S)
Output impedance	1 k Ω	-
Linearity	\leq \pm 1% F.S.	\leq \pm 1% F.S.
Zero-point	\leq 1 VDC \equiv \pm 2% F.S.	\leq DC 4 mA \pm 2% F.S.
Span	\leq 4 VDC \equiv \pm 2% F.S.	\leq DC 16 mA \pm 2% F.S.
Resolution	1/1000 or 1/2000 (different by pressure type and display unit)	
Response time	50 ms	70 ms

Display Type Pressure Sensors

PSB Series



Features

- High accuracy digital pressure sensor
- Bright red LED display (character height : 9.5 mm)
- High display resolution
 - : negative pressure 0.1 kPa / standard pressure 0.1 kPa, 1 kPa /
- compound pressure 0.2 kPa
- Unit conversion function
 - negative, compound pressure: kPa, kgf/cm², bar, psi, mmHg, mmH₂O, inHg
 - standard pressure: kPa, kgf/cm², bar, psi
- Various output modes: hysteresis mode, automatic sensitivity adjustment mode, independent 2-point output mode, window comparison output mode
- Chattering prevention function (response time: 2.5 ms, 5 ms, 100 ms, 500 ms)
- Analog output (1 - 5 VDC \pm) scale function
- Zero-point adjustment function
- Peak value and low value hold function
- Built-in reverse polarity protection circuit, overcurrent protection circuit

Specifications

Model	PSB-V01□□-□	PSB-01□□-□	PSB-1□□-□	PSB-C01□□-□
Pressure type	Gauge pressure			
Applicable medium	Air, Non-corrosive gas			
Pressure	Negative	Static	Compound	
Min display interval	1-digit ⁰¹⁾	1-digit ⁰¹⁾	2-digit	
Rated pressure range	0.0 to -101.3 kPa	0.0 to 100.0 kPa	0 to 1,000 kPa	-100.0 to 100.0 kPa
Display & setting pressure range	5.0 to -101.3 kPa	-5.0 to 110.0 kPa	-50 to 1,100 kPa	-101.2 to 110.0 kPa
Display type	7 segment LED, 3 1/2 digit			
Display accuracy	-10 to 0 °C: $\leq \pm 2\%$ F.S., 0 to 50 °C: $\leq \pm 1\%$ F.S.			
Max. pressure	Rated pressure $\times 2$	Rated pressure $\times 2$	Rated pressure $\times 1.5$	Rated pressure $\times 2$
01) psi unit: 2-digit				
Connection type	Cable type / Connector type model			
Cable	<ul style="list-style-type: none"> • Cable type: \varnothing 4 mm, 5-core, 2 m • Connector type: 5-core, 3 m 			
Wire spec.	AWG 24 (0.08 mm, 40-core), insulator diameter: \varnothing 1 mm			
Material	Case, Pressure port, Cover: IXEF			
Guaranteed parameter write life	100,000 times			
Protection structure	IP40 (IEC standard)			
Approval	CE ENEC			
Unit weight (packaged)	≈ 70 g (≈ 160 g)			
Power supply	12 - 24 VDC $\pm 10\%$ (ripple P-P: $\leq 10\%$)			
Current consumption	≤ 50 mA			
Control output	NPN open collector output / PNP open collector output model			
Load voltage	≤ 30 VDC \pm			
Load current	≤ 100 mA			
Residual voltage	NPN: ≤ 1 VDC \pm , PNP: ≤ 2 VDCT			
Hysteresis	Negative / Static: 1-digit (psi unit: 2-digit) Compound: 2-digit ⁰¹⁾			
Repeat error	Negative / Static: $\pm 0.2\%$ F.S. ± 1 digit Compound: $\pm 0.2\%$ F.S. ± 2 digits			
Response time	2.5, 5, 100, 500 ms			
Protection circuit	Output short over-current protection circuit			
Vibration	1.5 mm amplitude at frequency of 10 to 55 Hz (for 1 min) in each X, Y, Z direction for 2 hours			
Ambient temperature	-10 to 50 °C, storage: -20 to 60 °C (no freezing or condensation)			
Ambient humidity	35 to 85%RH, storage: 35 to 85%RH (no freezing or condensation)			
01) Due to the pressure unit operation, ± 1 digit errors may occur in the hysteresis.				
Analog output	Voltage (1 - 5 VDC $\pm 2\%$ F.S.)			
Output impedance	1 k Ω			
Linearity	$\leq \pm 2\%$ F.S.			
Zero-point	≤ 1 VDC $\pm 2\%$ F.S.			
Span	≤ 4 VDC $\pm 2\%$ F.S.			
Resolution	1/200			

Compact Pressure Sensors

PSS Series



Features

- Rated pressure range
 - negative pressure (0 kPa to -101.3 kPa)
 - positive pressure (0 kPa to 100.0 kPa / 0 kPa to 1000 kPa)
 - compound pressure (-101.3 kPa to 100 kPa)
- Compact size:
 - W 11.8 mm × H 29.3 mm × L 24.8 mm (with pressure port)
- Analog output: voltage (1 - 5 VDC \pm), current (DC 4 - 20 mA)
- Power supply: 12 - 24 VDC \pm \pm 10%

Specifications

Series	PSS series
Applicable medium	Air, Non-corrosive gas
Pressure type	Negative, Static, Compound
Rated pressure range	Refer to 'Model'.
Cable	Ø 3 mm, 4-core, 3 m
Wire	AWG28 (0.08 mm, 19-core) insulator diameter: Ø 0.88 mm
Material	• R1/8 pressure port - Front/Rear case: PBT, Pressure port: Nickel plated brass • Reducer pressure port - Front/Rear case and pressure port: PBT
Protection structure	IP40 (IEC standard)
Approval	CE ENEC
Unit weight (packaged)	\approx 26 g (\approx 60 g)
Power supply	12 - 24 VDC \pm \pm 10% (ripple P-P: \leq 10%)
Current consumption	Voltage output model: \leq 15 mA
Effect by power supply	\leq \pm 0.3%F.S
Protection circuit	Reverse polarity protection circuit
Voltage output	1 - 5 VDC \pm \pm 2% F.S.
Linearity	\leq \pm 1% F.S.
Output impedance	1 k Ω
Current output	DC 4 - 20 mA \pm 2% F.S.
Linearity	\leq \pm 1% F.S.
Analog output temp. characteristic	\leq \pm 2% F.S. (in 0 to 50 °C temperature range, at 25 °C)
Insulation resistance	\geq 50 M Ω (500 VDC \pm megger)
Dielectric strength	2,000 VAC \sim 50/60 Hz for 1 min
Vibration	1.5 mm amplitude at frequency of 10 to 55 Hz (for 1 min) in each X, Y, Z direction for 2 hours
Ambient temperature	0 to 50 °C, Storage: -10 to 60 °C (no freezing or condensation)
Ambient humidity	35 to 85%RH, Storage: 35 to 85%RH (no freezing or condensation)

Model

Model name	Pressure	Rated pressure range	Expanded analog output range	Max. pressure range	Output	□: Pressure port
PSS-V01V-□	Negative	0.0 to -101.3 kPa	5.0 to -101.3 kPa	Rated pressure \times 2	Voltage	R1/8: R1/8 (Standard) R04: Ø4 reducer R06: Ø6 reducer
PSS-V01A-□					Current	
PSS-01V-□	Static	0.0 to 100.0 kPa	-5.0 to 110.0 kPa	Rated pressure \times 2	Voltage	
PSS-01A-□					Current	
PSS-1V-□					Voltage	
PSS-1A-□					Current	
PSS-C01V-□	Com-pound	-101.3 to 100.0 kPa	-101.3 to 110.0 kPa	Rated pressure \times 2	Voltage	
PSS-C01A-□					Current	

Pressure Sensor Indicators

PSM Series



Features

- Display 8 (PSM8) or 4 (PSM4) channels of pressure value from pressure sensors
- Input range: 1 - 5 VDC \equiv , DC 4 - 20 mA (by model)
- Pressure sensor model auto recognition (Autonics PSS Series pressure sensors)
- Set PV display color by control output type (red / green)
- Individual output indicators for each channel
- RS485 (Modbus RTU) communication support
- Refrigeration pressure control mode
- Easy wiring and connection with sensor connectors (CNE)
- Power supply: 12 - 24 VDC \equiv \pm 10%

Specifications

Model	PSM4-□□□	PSM8-□□□
Display pressure range	Refer to 'Rated Pressure and Max. Pressure Display Range'.	
Max. inputs	4	8
Sensor input	<ul style="list-style-type: none"> • 1 - 5 VDC\equiv (Input impedance: \approx 300 kΩ) • DC 4 - 20 mA model (Input impedance: \approx 100 Ω) 	
Sensor supply power	12 - 24 VDC \equiv , 40 mA per channel (1 - 4 ch max. current: \leq 100 mA, 5 - 8 ch max. current: \leq 100 mA)	
Display type	7 Segment LED 4 digit	
Display accuracy	\pm 0.1% F.S. \pm 2 digit (at 23 \pm 5 $^{\circ}$ C)	
Control output and display temp. characteristic	-10 to 0 $^{\circ}$ C: \pm 0.3% F.S. \pm 2 digit 0 to 50 $^{\circ}$ C: \pm 0.2% F.S. \pm 2 digit (at 25 $^{\circ}$ C)	
Option input	Digital input 1	
Contact input	[L]: \leq 0.2 V	
Solid state input	Residual voltage \leq 1.0 V, Leakage current \leq 0.1 mA	
Protection structure	Front: IP65, the others: IP30 (IEC standard)	
Approval	CE ENEC	
Unit weight (packaged)	\approx 65 g (\approx 108 g)	
Power supply	12 - 24 VDC \equiv \pm 10% (ripple P-P: \leq 10%)	
Power consumption	\leq 3 W	
Current consumption	\leq 100 mA ⁰¹⁾	
Control output	NPN open collector output / PNP open collector output model	
Load voltage	\leq 30 VDC \equiv	
Load current	\leq 100 mA	
Residual voltage	NPN: \leq 1 VDC \equiv , PNP: \leq 2 VDC \equiv	
Hysteresis	Different by output operation mode ⁰²⁾	
Repeat error	\pm 0.1% F.S. \pm Min display interval	
Response time	<ul style="list-style-type: none"> • 4 CH model: 2.5, 100, 500, 1000 ms • 8 CH model: 5, 100, 500, 1000 ms 	
RS485 comm.	Modbus RTU	
Protection circuit	Output short over-current protection circuit, power supply reverse connection protection circuit	
Insulation resistance	\geq 100 M Ω (500 VDC \equiv megger)	
Dielectric strength	Between power terminal and case: 1,000 VAC \sim 50 / 60 Hz for 1 min Between power terminal and RS485 terminal: 500 VAC \sim 50 / 60 Hz for 1 min	
Vibration	1.5 mm amplitude at frequency of 10 to 55 Hz (for 1 min) in each X, Y, Z direction for 2 hours	
Ambient temperature	-10 to 50 $^{\circ}$ C, storage: -20 to 60 $^{\circ}$ C (rated at no freezing or condensation)	
Ambient humidity	30 to 85%RH, storage: 30 to 85%RH (rated at no freezing or condensation)	
Comm. protocol	Modbus RTU	

01) Except sensor consumption current.

All output indicators ON: \leq 120 mA / RS485 communication connection: 120 mA

02) Refer to output operation mode.

C. Machine Vision

Machine vision smart camera systems offer ideal machine vision solutions for identifying various objects during manufacturing processes.

C1. Smart Camera





C



C1. Smart Camera

Smart cameras can be used to analyze and process images captured by the embedded processor. In addition to the function of the vision sensor, various inspections such as barcode, OCR, and pattern recognition are possible.

C1-1	Smart Cameras	VC Series	5M Monochrome Smart Cameras (External Illumination)
	Vision Sensors	VG Series	0.4M Monochrome / Color Vision Sensors (Internal Illumination)

5M

Monochrome

Smart Cameras

(External Illumination)

VC Series



Features

- Various inspection functions
- Inspection simulator function
- Set up to 64 separate work group (32 inspection points per work group)
- Save data to FTP servers
- Support smart camera software (atVision)
 - Inspection simulator function, manage parameters and work group, inspection results monitoring, send data to FTP, multilingual support, etc.
- IP67 protection structure (IEC standard)
- C-Mount type
- Gigabit Ethernet communication

Specifications

Model	VC-M50T-CE
Image element	1 inch mono CMOS
Resolution	5 MP (2,560 × 2,048)
Frame per second	16 fps
Bit Depth	8 bit (256 gray level)
Shutter	Global shutter
Exposure time	3 μs to 3 sec
Lens type	C-Mount
eMMC	8 GB
DDR4	2 GB (LPDDR4), 512 MB (DDR4)
Inspection work group	64 (simultaneous inspection: 32)
Trigger mode	Continuous, External Trigger, Manual, Ethernet, RS232
Communication	Ethernet (TCP/IP & Modbus, 10/100/1000Base-T), RS232C
FTP trans. output	YES
Indicator	Power, LINK, DATA, USER 1, USER 2
Approval	CE, RoHS, ENEC, ERI
Unit weight (packaged)	≈ 600 g (= 780 g)
Power supply	24 VDC \pm 10%
Current consumption	≤ 1 A
Rated input signal	24 VDC \pm 10%
Output signal	NPN-PNP open collector output setting (software)
HS OUT 0	Strobe OUT
HS OUT 1	Inspection complete, Inspection result output (PASS / FAIL), Alarm, Camera work
Load voltage	24 VDC \pm
Load current	≤ 100 mA
Residual voltage	≤ 2.5 VDC \pm
Protection circuit	Output short overcurrent protection circuit, reverse voltage polarity protection circuit
Vibration	1.5 mm double amplitude at frequency 10 to 55 Hz (for 1 minute) in each X, Y, Z direction for 2 hours
Shock	300 m/s ² (≈ 30 G) in each X, Y, Z direction for 3 times
Ambient temp.	0 to 45 °C, storage: -30 to 80 °C (no freezing or condensation)
Ambient humi.	0 to 95%RH, storage: 0 to 95%RH (no freezing or condensation)
Protection structure	IP67 (IEC standard / When mounting waterproof lens cover)
Connection	Connector type
Connector spec.	Power I/O: M12 8-pin, Ethernet: M12 8-pin / RJ45 (cable tightening torque: 0.4 N m)
Material	Die-cast Aluminum Housing
Components	Ethernet connector Cap (screw plug - waterproof) × 1 (tightening torque: 0.4 N m)

Software

Download the installation file and the manuals from the Autonics website.

[atVision]

The program allows setting of smart camera parameters and management of monitoring data such as inspection status and status information.



0.4M Monochrome / Color Vision Sensors (Internal Illumination)

VG Series



Features

- Vision sensors with integrated LED lighting
- Global shutter method for accurate image capturing with minimal motion blur
- Enhanced optical performance with light interference prevention technology
- Tight lens cover attachment allows application in environments with dust or shock
- Various inspection functions
- Inspection simulator function
- Set up to 32 separate work group (64 inspection points per work group)
- Save data to FTP servers
- Free vision sensor software included (Vision Master): inspection simulator function, manage parameters and work group, inspection results monitoring, send data to FTP, multilingual support, etc.
- IP67 protection structure (IEC standard)

Specifications

Model	VG-M04□-□E			VG-C04□-□E		
Effective focal length	8 mm	16 mm	25 mm	8 mm	16 mm	25 mm
Min. working distance	50 mm	100 mm	200 mm	50 mm	100 mm	200 mm
Image filter	Preprocessing, external filter (color filter, polarizing filter)					
Image element	1/3 inch mono CMOS			1/3 inch color CMOS		
Resolution	752 × 480 pixel					
Image snap camera frame per second	≤ 60 fps ⁰¹⁾					
Shutter	Global shutter					
Exposure time	20 to 50,000 μs					
Inspection work group	32 (simultaneous inspection: 64)					
Inspection camera frame per second	≤ 60 fps ⁰¹⁾					
Dedicated software	Vision Master					
Light ON/OFF method	Pulse					
Light color	White / Red / Green / Blue model ⁰²⁾					
Trigger mode	External - Internal - Free run setting (software)					
Communication	Ethernet(TCP/IP), 100BASE-TX/10BASE-T					
FTP trans. output	YES					
Indicators	POWER (green), LINK (green), PASS (green), DATA (orange), FAIL (red)					
Approval	CE ENEC					
Unit weight (package)	≈ 273 g (≈ 415 g)	≈ 274 g (≈ 416 g)	≈ 274 g (≈ 416 g)	≈ 273 g (≈ 415 g)	≈ 274 g (≈ 416 g)	≈ 274 g (≈ 416 g)

01) The number of camera frames per second can be different by image setting or inspection item.
02) Available to buy separately and replace.

Power supply	24 VDC±10%
Current consumption	1 A
Rated input signal	24 VDC±10%
Output signal	NPN-PNP open collector output setting (software)
Load voltage	24 VDC±
Load current	≤ 50 mA
Residual voltage	≤ 1.5 VDC±
Protection circuit	Output short over current protection circuit
Insulation resistance	≥ 20MΩ (500 VDC± megger)
Dielectric strength	500 VAC~ 50/60 Hz for 1 min.
Vibration	1.5 mm amplitude at frequency of 10 to 55 Hz (for 1 min) in each X, Y, Z direction for 2 hours
Shock	300 m/s ² (≈ 30 G) in each X, Y, Z direction for 3 times
Ambient temperature	0 to 45 °C, storage: -20 to 70 °C (non-freezing or non-condensation)
Ambient humidity	35 to 85%RH, storage: 35 to 85%RH (non-freezing or non-condensation)
Protection structure	IP67 (IEC standards)
Connection	Connector type
Connector	Power I/O: M12 12-pin, Ethernet: M12 8-pin-RJ45
Material	Case: AL, lens cover: PC, focus adjuster: SUS, cable: PUR

Software

Download the installation file and the manuals from the Autonics website.

[Vision Master]

Vision Master is the vision sensor program that allows setting of vision sensor parameters and management of monitoring data such as inspection status and status information.

D. Safety

Safety products are installed in potentially dangerous or hazardous areas to safeguard personnel from injury and protect equipment from damage.

- D1. Safety Sensors
- D2. Safety Door Switches
- D3. Safety Switches
- D4. Safety Controllers





Safety

D



D1. Safety Sensors

Safety sensors are comprised of emitters and receivers. Operation of potentially dangerous machines are turned off when an object or person is detected between the emitter and receiver.

D1-1	Safety Light Curtains	SFL / SFLA Series	Safety Light Curtains (Standard Type / Advanced Type)
------	-----------------------	-------------------	---

Safety

Light Curtains

(Standard Type /
Advanced Type)

SFL / SFLA Series

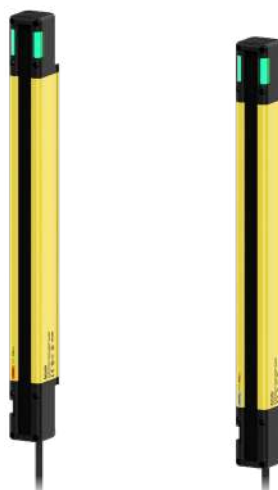



Features

- Select the light curtain suitable for the environmental condition with three detection capabilities: finger, hand, and hand-body
- Variable height for protection: 144 to 1868 mm
- Expend up to 4 sets of 400 beams with series connection
- Built-in various safety-related functions to deal with the field conditions: interlock, lockout, EDM, muting, override, blanking, and reduced resolution, etc.
- SFLA Series supports various functions via the dedicated software (atLightCurtain)
 - : Monitoring for real-time incident light level (SFL Series also supports it.)
 - : Provide a variety of functions to set including automatic setting for muting and blanking zone
 - : Save setting information of light curtain and apply the same settings to multiple light curtains
- Four mounting brackets (BK-SFL-□, sold separately) support various installation environments
- Select the sensing distance suitable for installation environment: Long or short mode
- Easy beam adjustment with the indicators at the top and bottom of the light curtain

Specifications

Type	Standard type		
Models	SFL14-□-□	SFL20-□-□	SFL30-□-□
Sensing type	Through-beam		
Light source	Infrared LED (855 nm)		
Effective aperture angle (EAA)	Within ± 2.5 ° when the sensing distance is greater than 3 m for both emitter and receiver.		
Sensing distance	Short - Long mode (setting switch)		
Short mode	0.2 to 5 m	0.2 to 8 m	0.2 to 8 m
Long mode	0.2 to 10 m	0.2 to 15 m	0.2 to 15 m
Detection capability	Ø 14 mm (finger)	Ø 20 mm (hand)	Ø 30 mm (hand-body)
Detection object	Opaque object		
Number of optical axes ⁰¹⁾	15 to 111	12 to 68	42 to 75
Protective height	144 to 1,008 mm	183 to 1,023 mm	1,043 to 1,868 mm
Optical axis pitch	9 mm	15 mm	25 mm
Series connection	Max. 3 SET (≤ 300 optical axes)		
Type	Advanced type		
Models	SFLA14-□-□	SFLA20-□-□	SFLA30-□-□
Sensing type	Through-beam		
Light source	Infrared LED (855 nm)		
Effective aperture angle (EAA)	Within ± 2.5 ° when the sensing distance is greater than 3 m for both emitter and receiver.		
Sensing distance	Short - Long mode (setting switch or atLightCurtain)		
Short mode	0.2 to 5 m	0.2 to 8 m	0.2 to 8 m
Long mode	0.2 to 10 m	0.2 to 15 m	0.2 to 15 m
Detection capability	Ø 14 mm (finger)	Ø 20 mm (hand)	Ø 30 mm (hand-body)
Detection object	Opaque object		
Number of optical axes ⁰¹⁾	15 to 199	12 to 124	9 to 75
Protective height	144 to 1,800 mm	183 to 1,863 mm	218 to 1,868 mm
Optical axis pitch	9 mm	15 mm	25 mm
Series connection	Max. 4 SET (≤ 400 optical axes)		

- Easy switching NPN or PNP output via switch or dedicated software (atLightCurtain)
- Excellent visibility for the status of the light curtain with 7-segment display
- Built-in self-diagnosis function such as mutual interference prevention and disturbance light detection
- Easy to identify the operating status with the upper OSSD indicator without an additional device
- Four kinds of non-safety outputs for a variety of environmental conditions: AUX 1/2, and Lamp 1/2
- The product structure conforms with international safety regulations and standards: Type 4 ESPE (AOPD), SIL3, SIL CL3, Cat. 4, PL e, CE, UL Listed, S Mark and KCs (some of the models)
- Protection rating: IP65, IP67 (IEC standard), IP67G (JEM standard), IP69K (DIN standard)

Power supply	24 VDC \pm 20 % (Ripple P-P: \leq 10 %)
Current consumption ⁰¹⁾	Emitter: \leq 106 mA, receiver: \leq 181 mA
Response time ⁰¹⁾	T _{OFF} (ON \rightarrow OFF): \leq 32.3 ms, T _{ON} (OFF \rightarrow ON): \leq 76.6 ms
Safety related output : OSSD output	NPN or PNP open collector Load voltage ⁰²⁾ : ON - 24 VDC \pm (except for the residual voltage), OFF - 0 VDC \pm , Load current ⁰³⁾ : \leq 300 mA, Residual voltage ⁰⁴⁾ : \leq 2 VDC \pm (except for voltage drop due to wiring), Load capability: \leq 2.2 μ F, Leakage current: \leq 2.0 mA, Wire resistance of load: \leq 2.7 Ω
Auxiliary output (AUX 1/2) ⁰⁵⁾	NPN or PNP open collector Load voltage: \leq 24 VDC \pm , Load current: \leq 100 mA, Residual voltage: \leq 2 VDC \pm (except for voltage drop due to wiring)
Lamp output (LAMP 1/2) ⁰⁵⁾	NPN or PNP open collector Load voltage: \leq 24 VDC \pm , Load current: \leq 300 mA, Residual voltage: \leq 2 VDC \pm (except for voltage drop due to wiring), Incandescent lamp: 24 VDC \pm / 3 to 7 W, LED lamp: Load current \leq 10 to 300 mA (V _f : \leq 1.5 VDC \pm)
External input	Reset input, mute 1/2 input, EDM, external test When setting NPN output ON: 0 - 3 VDC \pm , OFF: 9 - 24 VDC \pm or open, short-circuit current: \leq 3 mA When setting PNP output ON: 9 - 24 VDC \pm , OFF: 0 - 3 VDC \pm or open, short-circuit current: \leq 3 mA
Protection circuit	Reverse power polarity, reverse output polarity, output short-circuit over-current protection
Safety-related functions	Interlock (reset hold), external device monitoring (EDM), muting/override, Blanking (fixed blanking, floating blanking), reduced resolution
General functions	Self-test, alarm for reduction of incident light level, mutual interference prevention
Others functions	Change of sensing distance, switching to NPN or PNP, external test (light emission stops), auxiliary output (AUX 1, 2), lamp output (LAMP 1, 2)
Synchronization type	Timing method by RS485 synchronous line
Insulation resistance	\geq 20M Ω (at 500 VDC \pm megger)
Noise immunity	\pm 240 VDC \pm the square wave noise (pulse width: 1 μ s) by the noise simulation
Dielectric strength	1,000 VAC \sim 50 / 60 Hz for 1 minute
Vibration	0.7 mm double amplitude at frequency of 10 to 55 Hz (for 1 min), 20 sweeps in each X, Y, Z direction
Shock	100 m/s ² (\approx 10 G), pulse width 16 ms in each X, Y, Z direction for 1,000 times
Ambient illumination (receiver)	Incandescent lamp: \leq 3,000 lx, sunlight: \leq 10,000 lx
Ambient temperature	-10 to 55 °C, storage: -20 to 70 °C (no freezing or condensation)
Ambient humidity	35 to 85 %RH, storage: 35 to 95 %RH (no freezing or condensation)
Protection rating ⁰⁶⁾	IP65, IP67 (IEC standard), IP67G (JEM Standard), IP69K (DIN standard)
Material	Case: Aluminum, Front cover and sensing part: Polymethyl methacrylate, End cap: polycarbonate, Power I/O cable and connector cable: polyurethane (PUR) or polyvinyl chloride (PVC), Y type connector cable: polyvinyl chloride (PVC), lamp output cable and series connector cable: polyurethane (PUR)
Approval	   (INDUSTRIAL ROBOT PROTECTION DEVICE) ⁰⁷⁾
International standards	UL 508, CSA C22.2 No. 14, ISO 13849-1 (PL e, Cat. 4), ISO 13849-2 (PL e, Cat. 4), UL 61496-1 (Type 4, ESPE), UL 61496-2 (Type 4, AOPDs), IEC/EN 61496-1 (Type 4, ESPE), IEC/EN 61496-2 (Type 4, AOPDs), IEC/EN 61508-1--7 (SIL 3), IEC/EN 62061 (SIL CL 3)

01) It may differ depending on the models. For more information, refer to the "SFL/SFLA User Manual."

02) The values of load voltage were drawn with PNP output, and in case of NPN output, apply these in reverse.

03) Be sure that the load current should be greater than 6 mA.

04) The residual voltage was drawn with 300 mA of load current.

05) It is the non-safety output. Do not use it for safety purposes.

06) Approved certification protection ratings are IP65 and IP67.

07) Refer to the "SFL/SFLA User Manual" for certified by model. The certified models for S-Mark and KCs (industrial robot protection device) have the same functional basis.

Software

Download the installation file and the manuals from the Autonics website.

[atLightCurtain]

It is that provides configuration and monitoring of light curtain.

In case of SFL (Standard type), only monitoring function is supported, and in case of SFLA (advanced type), all functions such as parameter setting are available.



D

D2. Safety Door Switches

Safety door switches can detect opening and closing of doors in machines, and also keep the door locked during potentially dangerous operation.

D2-1	Safety Door Lock Switches	SFDL Series	Safety Door Lock Switches
D2-2		SFDL2 Series	Safety Flat Type Door Lock Switches
D2-3	Safety Door Switches	SFD Series	Safety Door Switches
D2-4		SFN Series	Safety Non-Contact Door Switches

Safety

Door Lock Switches

SFDL Series



Features

- Available to change the direction of inserting the operation key by rotating head: Inserting the operation key from 5 directions in the top and side
- Various kinds of contact composition: 4-contact (connected), 4-contact (not connected), 5-contact, 6-contact
- Selectable between connector type which reduces working process and separable terminal type which is useful for maintenance
- Manual unlock function to handle the emergency: Cross type / special type release key line-up
- Minimized solenoid heat with stable current supply
- Excellent solidity / durability of metallic head
- Applicable to various applications using the slide key unit accessory

Specifications

Model	SFDL-□□□-□□	SFDL-□□□-C□□
Directing opening force	≥ 80 N	
Directing opening distance	≥ 10 mm	
Locking pullout strength	≥ 1,300 N	
Operating speed	0.05 to 1 m/s	
Operating frequency	≤ 20/min	
Mechanical life cycle	≥ 1,000,000 operations (20/min)	
Vibration (malfunction)	0.35mm amplitude at frequency of 10 to 55 Hz (for 1 min) in each X, Y, Z direction for 10 min	
Shock	1,000 m/s ² (≈ 100 G) in each X, Y, Z direction for 3 times	
Shock (malfunction)	80 m/s ² (≈ 8 G) in each X, Y, Z direction for 3 times	
Ambient temperature	-10 to 55°C ⁰¹⁾ , storage: -25 to 65 °C (a non freezing or condensation environment)	
Ambient humidity	35 to 85 %RH, storage: 35 to 85 %RH (a non freezing or condensation environment)	
Protection structure	IP67 ⁰²⁾ (IEC standard, except for head)	
Material	Head: zinc, case: polyamide 66, operation key: stainless steel 304	
Approval	CE (TUV NORD)	
Accessory	SFDL-□□□-□□□K (Special type release key) : rotating key	
Applicable cable	AWG22	-
Connection type	Terminal type	Connector type
Unit weight (packaged)	≈ 375 g (≈ 440 g)	≈ 325 g (≈ 395 g)

01) UL approved ambient temperature: 50°C

02) Rated protection structure is for the switch body. Be cautious about preventing the head part from entering the foreign materials such as dust and water.

Contact block	
Rated voltage/current for load	Resistive load: 1 A/120 VAC~, 0.22 A/125 VDC= Inductive load (IEC): AC-15 1 A/120 VAC~, DC-13 0.22 A/125 VDC= Inductive load (UL): C150, R150
Impulse dielectric strength	Between the terminals of same polarity: 1.5 kV Between the terminals of different polarity: 1.5 kV Between each terminal and non-live part: 2.5kV
Insulation resistance	≥ 100 MΩ (500 VDC= megger)
Contact resistance	≤ 200 mΩ
Electrical life cycle	≥ 100,000 operations (125 VAC~/1 A)
Conditional short-circuit current	100 A
Solenoid	
Rated voltage	24 VDC= class 2
Current consumption	Supplying power: 0.26A Normal: max. 0.2A (approx. 3 seconds after supplying power)
Insulation class	Class E

Safety

Flat Type

Door Lock Switches

SFDL2 Series



Features

- Slim size W 90 x H 105 x D 35.5 mm
- Head unit can be rotated to change insert direction of operation key:
Operation key can be inserted from 4 directions (top / sides)
- Various contact types (up to 6-contacts):
Lock N.C. 2 / N.O. 1 + Door N.C. 2 / N.O.1
Lock N.C. 3 + Door N.C. 2 / N.O.1
Lock N.C. 2 / N.O. 1 + Door N.C. 3
Lock N.C. 3 + Door N.C. 3
- Manual unlock function (release key) for emergencies during installation or testing:
Standard (cross) type and special type release keys, rear release button
- Two lock-release methods:
Mechanical lock-solenoid release,
solenoid lock-mechanical release models
- Different installation types depending on operation key insertion position:
Front / rear installation models
- Excellent strength and durability with metal head model

Specifications

Model	SFDL2-□□□-□□□-□□ SFDL2-□□□-□□□K-□	SFDL2-□□□-□□□ B-□ SFDL2-□□□-□□□KB-□
Directing opening force	≥ 80 N	
Directing opening distance	≥ 10 mm	
Locking pullout strength	≥ 1,300 N	
Operating speed	0.05 to 1 m/s	
Operating frequency	≤ 20/min	
Mechanical life cycle	≥ 1,000,000 operations (20/min)	
Indicator	Solenoid status or contact status (orange, depending on connection)	-
Vibration (malfunction)	0.35mm amplitude at frequency of 10 to 55 Hz (for 1 min) in each X, Y, Z direction for 10 min	
Shock	1,000 m/s ² (≈ 100 G) in each X, Y, Z direction for 3 times	
Shock (malfunction)	80 m/s ² (≈ 8 G) in each X, Y, Z direction for 3 times	
Ambient temperature	-10 to 55°C, storage: -25 to 65 °C (a non freezing or condensation environment)	
Ambient humidity	35 to 85 %RH , storage: 35 to 85 %RH (a non freezing or condensation environment)	
Protection structure	IP67 ⁰¹⁾ (IEC standard, except for head)	
Material	Head: zinc or PA, case: PA	
Approval	CE (TUV NORD) · · ·	
Accessory	SFDL2-□□□□-□□□K/KB-□ (Special type release key): rotating key	
Unit weight (packaged)	Normal type: ≈ 400 g (≈ 490 g), rear release button type: ≈ 395 g (≈ 485 g)	
<small>01) Rated protection structure is for the switch body. Be cautious about preventing the head part from entering the foreign materials such as dust and water.</small>		
Contact block		
Rated voltage/current for load	Resistive load: 6 A/250 VAC~, 0.6 A/250 VDC= Inductive load (IEC): AC-15 3 A/240 VAC~, DC-13 0.27 A/250 VDC= Inductive load (UL): A300, Q300	
Impulse dielectric strength	Between the terminals of same polarity: 2.5 kV Between the terminals of different polarity: 4 kV Between each terminal and non-live part: 6 kV	
Insulation resistance	≥ 100 MΩ (500 VDC= megger)	
Contact resistance	≤ 100 mΩ	
Electrical life cycle	≥ 100,000 operations (250 VAC~/6 A)	
Conditional short-circuit current	100 A	
Solenoid		
Rated voltage	24 VDC=, class 2	
Current consumption	Supplying power: 0.26A Normal: max. 0.2A (approx. 3 seconds after supplying power)	
Insulation class	Class E	
Indicator LED		
Rated voltage	24 VDC=	
Current consumption	2.2 mA	

Safety

Door Switches





SFD Series



Features

- Available to change the direction of inserting the operation key by rotating head: Inserting the operation key from 5 directions in the top and side
- Various kinds of contact composition: 1 N.O. + 1 N.C., 2 N.C., 1 N.O. + 2 N.C., 3 N.C.
- Selectable between connector type which reduces working process and terminal type which is useful for maintenance
- Selectable head material between metal and plastic

Specifications

Model	SFD-□□-□M20	SFD-□□-□G1/2	SFD-□□-□C
Rated voltage/current for load	Resistive load: 6 A/250 VAC~, 0.6 A/250 VDC≐ Inductive load (IEC): AC-15 3 A/240 VAC~, DC-13 0.27 A/250 VDC≐ Inductive load (UL): A300, Q300		
Directing opening force	≥ 80 N		
Directing opening distance	≥ 10 mm		
Operating speed	0.05 to 1 m/s		
Operating frequency	≤ 20/min		
Insulation resistance	≥ 100 MΩ (500 VDC≐ megger)		
Contact resistance	≤ 50 mΩ (initial value)		
Impulse dielectric strength	Between the terminals: 2 kV (IEC 60947-5-1) Between each terminal and non-live part: 5 kV (IEC 60947-5-1)		
Conditional short circuit current	100 A		
Life cycle	Electrical: ≥ 100,000 operations (240 VAC~ 6 A) Mechanical: ≥ 1,000,000 operations		
Vibration (malfunction)	0.75 mm amplitude at frequency of 10 to 55 Hz (for 1 min) in each X, Y, Z direction for 10 min		
Shock	1,000 m/s ² (≈ 100 G) in each X, Y, Z direction for 3 times		
Shock (malfunction)	300 m/s ² (≈ 30 G) in each X, Y, Z direction for 3 times		
Ambient temperature	-30 to 70°C, storage: -40 to 70 °C ⁰¹⁾ (no freezing or condensation)		
Ambient humidity	35 to 90 %RH, storage: 35 to 90 %RH (no freezing or condensation)		
Protection structure	IP67 ⁰²⁾ (IEC standard, except for head)		
Material	Plastic head - polyamide 6, metallic head - zinc case: polyamide 6, operation key: stainless steel 304		
Approval	CE (TUV NORD)     EAC		
Connection type	M20 connector cable	G1/2 connector cable	M12 plug connector
Unit weight (packaged)	<ul style="list-style-type: none"> • 1 connection outlet plastic: ≈ 80 g (≈ 120 g) metallic: ≈ 110 g (≈ 150 g) • 2 connection outlet plastic: ≈ 110 g (≈ 140 g) metallic: ≈ 130 g (≈ 170 g) 		<ul style="list-style-type: none"> Plastic: ≈ 85 g (≈ 130 g) Metallic: ≈ 115 g (≈ 160 g)

01) UL approved ambient temperature: 65°C

02) Rated protection structure is for the switch body. Be cautious about preventing the head part from entering the foreign materials such as dust and water.

Safety

Non-Contact Door Switches

SFN Series



Features

- Vertical / Horizontal installation supported
- Available to install at back-forth, up-down, right-left moving door
- Connectible maximum 30 units to one controller
- Easy notification of operation status with an operation indicator (ON: green, OFF: red)

Specifications

Model	SFN-M-□	
Operating distance ⁰¹⁾	OFF→ON	≥ 5 mm
	ON→OFF	≤ 15 mm
Approval	CE (TUV NORD) · · ·	
Unit weight (packaged)	Cable type (2 m): ≈ 100.5 g (≈ 113.8 g) Cable type (5 m): ≈ 199.5 g (≈ 214.8 g) Cable connector type: ≈ 58.1 g (≈ 71.6 g)	
01) It is rated at 23°C of ambient temperature, and it may be differed up to ± 20 % by ambient temperature.		
Power supply	24 VDC≐ (± 10 %)	
Operating frequency	100 Hz	
Power consumption ⁰¹⁾	≤ 400 mA	
Auxiliary output	PNP open collector output - 24 VDC≐, 10 mA	
Operation indicator	ON: green, OFF: red	
Life expectancy	≥ 20,000,000 times (with low load)	
Insulation resistance	≥ 50 MΩ (500 VDC≐ megger)	
Protection circuit	Surge protection circuit, output short over current protection circuit, reverse polarity protection circuit	
Dielectric strength	1,500 VAC~ 50/60Hz for 1 minute	
Vibration	1.0 mm amplitude at frequency of 10 to 55 Hz (for 1 min) in each X, Y, Z direction for 2 hours	
Vibration (malfunction)	1.0 mm amplitude at frequency of 10 to 55 Hz (for 1 min) in each X, Y, Z direction for 10 min	
Shock	300 m/s ² (≈ 30 G) in each X, Y, Z direction for 3 times	
Shock (malfunction)	300m/s ² (≈ 30G) in each X, Y, Z direction in output ON/OFF status for 3 times	
Ambient temperature	-10 to 55 °C, storage : -20 to 60 °C (no freezing or condensation)	
Ambient humidity	35 to 85 %RH, storage : 35 to 85 %RH (no freezing or condensation)	
Protection structure	IP67 (IEC standard)	
Connection	Cable type / cable connector type model	
Cable	Ø 5 mm, 5-wire, cable type: 2 m / 5 m, cable connector type: 0.3 m	
Wire	AWG26 (0.08 mm), 28-core, core diameter: Ø 0.74 mm	
Connector spec.	M12 plug connector	
Material	Body/CAP: PC	

01) Power to the load is not included.

Characteristic level / Safety category (with SFC-N322)	IEC 61508 SIL 3
	IEC 62061 SIL CL 3
	ISO 13849-1 PLc Cat.4
	- HFT = 1
	- Diagnostic Coverage : 99 % (high)
	- MTTFd = 100 year (high)
- Mission time = 20 year	
- PFH = 3.88E-09	

Safety status in case of error: the switch does not have an internal error recognition function, so it cannot maintain a safety status in the event of error. Error recognition is processed in the connected controller (SFC-N322).



D3. Safety Switches

Safety switches safeguard personnel from injury and protect equipment from damage in potentially dangerous areas.

D3-1	Emergency Stop Switches	SF2ER Series	Ø 22 / 25 mm Round Mount Emergency Stop Switches
D3-2	Safety Enabling Switches	SFEN Series	Safety Grip Type Enabling Switches
D3-3	Safety Key Selector Switches	SF2KR Series	Safety Key Selector Switches

Ø 22 / 25 mm Round Mount Emergency Stop Switches

SF2ER Series



Features

- Easy mounting and removing of Contact Units using a lever
- Adoptable maximum three contact units in series to improve wiring efficiency
- Available to install using either round or forked crimp terminals
- Oil resistant to IP65 protection structure
- Circuit interruption function with a direct opening mechanism for the occurrence of error such as contact weld
- Supplying a various kind of accessories for improving usability
 - Ø 22 / 25 mm guard ring for emergency stop switches
 - Ø 22 / 25 mm name plate for emergency stop switches
 - Ø 22 / 25 mm contact block for emergency stop switches

Specifications

Model	SF2ER-□□□□-□
Rated voltage / current	IEC: AC-15 (220 VAC~, 3 A), DC-13 (220 VDC=, 0.2 A) UL: A300, Q300
Contact operating power	3.0 to 8.0 N/ 1 contact
Operation distance	5.0 mm (0/-0.5)
Rotation angle	CW (clock wise) 52°
Allowable operation frequency ⁰¹⁾	Mechanical: 20 times/minute, electrical: 20 times/minute
Life cycle	Mechanical: ≥ 250,000 times, electrical: ≥ 100,000 times
Applicable wire	AWG 18 (0.823 mm ²)
Insulation resistance	≥ 100 MΩ (500 VDC= megger)
Dielectric strength	2,500 VAC~ 50/60 Hz for 1 minute
Vibration	1.5 mm double amplitude at frequency of 10 to 55 Hz (for 1 min) in each X, Y, Z direction for 2 hours
Vibration (malfunction)	15 mm double amplitude at frequency of 10 to 55 Hz (for 1 min) in each X, Y, Z direction for 10 minutes
Shock	1,000 m/s ² (≈ 100 g) in each X, Y, Z direction for 3 times
Shock (malfunction)	250 m/s ² (≈ 25 g) in each X, Y, Z direction for 3 times
Ambient temperature	-20 to 65°C ⁰²⁾ , storage: -40 to 70 °C (at no freezing or condensation)
Ambient humidity	35 to 85 %RH, storage: 35 to 85 %RH (at no freezing or condensation)
Protection structure	IP65 ⁰³⁾ (oil resistant, IEC standards)
Material	Button: PC, body: PA6, lever in fixing unit: PA6
Approval	CE (TUV NORD)
Weight ⁰⁴⁾	≈ 66g

01) Setting and resetting once is counted as one operation.

02) UL approved ambient temperature: 55 °C

03) It is only for part from front of the panel. Protection structure is guaranteed only when the switch is installed on flat and smooth surface with mounting holes Ø22mm.

04) It is switch with three contact blocks.

[Contact capacity]

IEC (EN60947-5-1)

Rated current		10 A			
Rated voltage		24 V	110 V	220 V	380 V
AC	Resistive load (AC-12)	10 A	10 A	6 A	3 A
	Inductive load (AC-15)	10 A	5 A	3 A	2 A
DC	Resistive load (DC-12)	10 A	2 A	0.6 A	0.2 A
	Inductive load (DC-13)	1.5 A	0.5 A	0.2 A	0.1 A

UL / CSA (UL508, CSA C22.2 No. 14)

A300

Rated voltage	Through current	Current (A)		Volt ampere (VA)	
		Making	Breaking	Making	Breaking
AC120 V	10 A	60	6	7,200	720
AC240 V		30	3		

Q300

Rated voltage	Through current	Current (A)		Volt ampere (VA)	
		Making	Breaking	Making	Breaking
DC125 V	2.5 A	0.55	0.55	69	69
DC250 V		0.27	0.27		

Safety

Grip Type Enabling Switches

SFEN Series



Features

- Models: Standard / Stop button / Momentary button type
- High operation sensitivity with 3-position snap action
- Enable operation indicator (green LED)
- Various contact types
 - : Standard type N.O. 2 + N.C. 1
 - : Stop button type N.O. 2 + N.C. 2
 - : Momentary button type N.O. 2 + N.O. 2
- Secure connection with cable gland
- Holding key SFEN-HK (sold separately): for connection with safety door switch (SFD Series)

Specifications

[Enable switch]

Rated Insulation Voltage	250 VAC~
Rated through current	2.5 A
Rated inductive load	AC-15 (0.75 A / 240 VAC~), DC-13 (0.55 A / 125 VDC=)
Rated resistive load ⁰¹⁾	0.75 A / 240 VAC~, 0.55 A / 125 VDC=
Controller strength ⁰²⁾	Operation direction: 200 N, for 1 min
Operating frequency	Electrical: ≤ 20 / min, Mechanical: ≤ 20 / min
Dielectric strength	Between terminals of same polarity, between terminals of different polarity, between terminal and non-live part : 2,500 VAC~ 50 / 60 Hz for 1 min (impulse dielectric strength)
Electrical life cycle	≥ 100,000 operations (rated load)
Mechanical life cycle	OFF → ON → OFF: ≥ 100,000 operations / OFF → ON: ≥ 1,000,000 operations

01) Use a 10 A fuse gl or gG conforming to IEC60269 as short-circuit protection. The body does not have a built-in fuse.
02) Do not use the switch more than the controller strength. Failure to follow this instruction may result in product damage.

[Stop button]

Rated Insulation Voltage	250 VAC~
Rated through current	3 A
Rated resistive load ⁰¹⁾	AC-12 (3 A / 250 VAC~), DC-12 (3 A / 30 VDC=)
Controller strength ⁰²⁾	Operation direction: 400 N, for 1 min (operation direction: 0.5 N m, for 1 min)
Operating frequency	Electrical: ≤ 10 / min, Mechanical: ≤ 10 / min
Dielectric strength	Between terminals of same polarity: 1,000 VAC~ 50 / 60 Hz for 1 min. between terminals of different polarity, between terminal and non-live part : 2,000 VAC~ 50 / 60 Hz for 1 min.
Electrical life cycle	≥ 100,000 operations (rated load) (Push / Release 1 time)
Mechanical life cycle	≥ 100,000 operations (Push / Release 1 time)

01) Use a 10 A fuse gl or gG conforming to IEC60269 as short-circuit protection. The body does not have a built-in fuse.
02) Do not use the button more than the controller strength. Failure to follow this instruction may result in product damage.





[Momentary button]

Rated Insulation Voltage	125 VAC~
Rated through current	0.1 A
Rated resistive load ⁰¹⁾	AC-12 (0.1 A / 125 VAC~), DC-12 (0.1 A / 30 VDC=)
Controller strength ⁰²⁾	Operation direction: 10 N, for 1 min
Operating frequency	Electrical: ≤ 25 / min, Mechanical: ≤ 60 / min
Dielectric strength	Between terminals of same polarity: 600 VAC~ 50 / 60 Hz for 1 min. between terminals of different polarity, between terminal and non-live part : 1,000 VAC~ 50 / 60 Hz for 1 min.
Electrical life cycle	≥ 100,000 operations (rated load)
Mechanical life cycle	≥ 1,000,000 operations

01) Use a 10 A fuse gl or gG conforming to IEC60269 as short-circuit protection. The body does not have a built-in fuse.
02) Do not use the button more than the controller strength. Failure to follow this instruction may result in product damage.

Next Page ►

[Common spec.]

Conditional short circuit current	100 A
Min. applied load	DC24 V 4 mA
Directing opening force	30 N ± 10
Directing opening distance	4.8 mm ± 0.5
Insulation resistance	≥ 100 MΩ (500 VDC≡ megger)
Vibration (malfunction)	1.5 mm double amplitude at frequency of 10 to 55 Hz (for 1 min) in each X, Y, Z direction for 10 min
Shock (malfunction)	150 m/s ² (≈ 15 G) in each X, Y, Z direction for 3 times
Ambient temperature	-10 to 55 °C, storage: -25 to 65 °C (no freezing or condensation)
Ambient humidity	35 to 85 %RH, storage: 35 to 85 %RH (no freezing or condensation)
Insulation class	Class II (double insulation)
Indicator	Enable operation indicator (green)
Protection structure	SFEN: IP66 (IEC standard) SFEN-B, SFEN-M: IP65 (IEC standard)
Applicable wire	AWG 20 to 18 (0.5 to 0.75 mm ²)
Connection type	M20 connector cable grand
Material	Cover: PA66, button: PC, rubber grip: Silicone
International standards	IEC 60947-5-1, IEC 60947-5-8, UL 60947-5-1
Approval	CE (TUV NORD)    
Unit weight (package)	SFEN: ≈ 238 g (≈ 363 g) SFEN-B: ≈ 268 g (≈ 388 g) SFEN-M: ≈ 252 g (≈ 376 g)

[Contact composition]

	SFEN	SFEN-B	SFEN-M
Enable switch	2 N.O.	2 N.O.	2 N.O.
Option output	1 N.C.	-	-
Stop button	-	2 N.C.	-
Momentary button	-	-	2 N.O.

Safety

Key Selector Switches



SF2KR Series



Features

- Easy to check the lock / unlock status by the front solenoid operation indicator (lockable model: SF2KR-M)
- Various line-up of key free location, N.C. contact powered location, and lock location depending on the general / lockable type
- Contact block option up to 4 contacts: N.O. 1 + N.C. 2, N.C. 3, N.O. 2 + N.C. 2
- 10 different types of keys
- Sold separately
 - : Name plate (SF2KR-□-NP□)
 - : Contact block (SFEA-C□)

Specifications

Model	SF2KR-□-□-□	SF2KR-M□-□-□
Solenoid input voltage	-	Non-polar 24 VDC \pm (± 10%)
Solenoid current consumption	-	38.7 mA ± 5%
Conditional short circuit current	100 A	
Indicator	-	Solenoid operation (green)
Applicable wire	Contact: AWG 18 (0.823 mm ²)	Solenoid power: AWG 24 - 18 Contact: AWG 18 (0.823 mm ²)
Allowable operation frequency ⁰¹⁾	30 times/minute	
Life cycle	Mechanical: ≥ 100,000 times, electrical: ≥ 100,000 times	
Key pushing force	≥ 20 N	
Key rotating torque	0.2 to 1.8 N·m	
Insulation resistance	≥ 100 MΩ (500 VDC \pm megger)	
Dielectric strength	2,500 VAC \sim 50/60 Hz for 1 minute	
Vibration	1.5 mm double amplitude at frequency of 10 to 55 Hz (for 1 min) in each X, Y, Z direction for 2 hours	
Vibration (malfunction)	1.5 mm double amplitude at frequency of 10 to 55 Hz (for 1 min) in each X, Y, Z direction for 10 minutes	
Shock	300 m/s ² (\approx 30 g) in each X, Y, Z direction for 3 times	
Shock (malfunction)	150 m/s ² (\approx 15 g) in each X, Y, Z direction for 3 times	
Ambient temperature	-20 to 70°C ⁰²⁾ , storage: -40 to 70 °C (at no freezing or condensation)	-10 to 55°C ⁰²⁾ , storage: -20 to 70 °C (at no freezing or condensation)
Ambient humidity	35 to 85%RH, storage: 35 to 85%RH (at no freezing or condensation)	
Protection structure	IP65 (front panel, IEC standard)	
Material	PC, POM	
Approval	CE (TUV NORD) :   	
Unit weight (packaged) ⁰³⁾	\approx 130 g (\approx 192 g)	\approx 152 g (\approx 213 g)

01) Rotating and retuning once is counted as one operation.

02) UL approved ambient temperature: 55 °C

03) It is switch with contact blocks.

[Contact capacity]

IEC (EN60947-5-1)

Rated current		10 A			
Rated voltage		24 V	110 V	220 V	380 V
AC	Resistive load (AC-12)	10 A	10 A	6 A	3 A
	Inductive load (AC-15)	10 A	5 A	3 A	2 A
DC	Resistive load (DC-12)	10 A	2 A	0.6 A	0.2 A
	Inductive load (DC-13)	1.5 A	0.5 A	0.2 A	0.1 A

UL / CSA (UL508, CSA C22.2 No. 14)

A300

Rated voltage	Through current	Current (A)		Volt ampere (VA)	
		Making	Breaking	Making	Breaking
AC120 V	10 A	60	6	7,200	720
AC240 V		30	3		

Q300

Rated voltage	Through current	Current (A)		Volt ampere (VA)	
		Making	Breaking	Making	Breaking
DC125 V	2.5 A	0.55	0.55	69	69
DC250 V		0.27	0.27		



D4. Safety Controllers

Safety controllers are used to transmit input and output signals of safety devices and prevent dangerous situations.

Safety Controllers / Safety Relay Unit

























SFC / SFC-R Series



Features

- Slim size (17.5 / 22.5 / 35 mm) for saving installation space
- Various LED indicators for displaying status (power / input / logic input / error / feed back / output)
- Screw / Screwless connection models
- P channel FET / Relay contact safety output models
- Available off-delay output and time setting (advanced/non-contact door switch / relay output models)
- Available logic (AND) connection and extension relay unit connection (advanced / non-contact door switch models)
- The product structure conforms with international safety regulations and standards: SIL3, SIL CL3, PLe, CE, UL Listed, and S Mark

Specifications

Unit	Basic	Advanced	Non-contact door switch
Model	SFC-422-□	SFC-A322-2□-□	SFC-N322-2□-□
Power supply	24 VDC=		
Allowable voltage range	85 to 110% of rated voltage		
Power consumption ⁰¹⁾	≤ 2.5 W	≤ 3.0 W	≤ 3.5 W
Input	ON: ≥ 11 VDC= ≥ 5 mA, OFF: ≤ 5 VDC= ≤ 1 mA		
Input time	≥ 50 ms, feedback start (manual) : ≥ 100 ms		
Cable	≤ 100 m (≤ 100Ω, ≤ 10nF)		
Safety output	P channel FET ⁰²⁾		
Instantaneous	4 ×	3 × ⁰³⁾	3 × ⁰³⁾
Off-delay ⁰⁴⁾	-	2 × ⁰³⁾	2 × ⁰³⁾
Time accuracy	-	≤ ± 5%	
Load current	Below 2-point output: ≤ DC 1 A, Over 3-point output: ≤ DC 0.8 A		
Leakage current	≤ 0.1 mA		
Operating time (OFF → ON) ⁰⁵⁾	Safety input: ≤ 50 ms		
	-	Logic input: ≤ 200 ms	
	-	-	Non-contact door switch input: ≤ 100 ms
Response (return) time (ON → OFF) ⁰⁵⁾	≤ 15 ms, non-contact door switch input or logic input: ≤ 20 ms		
Auxiliary output	2 × PNP transistor: X1, X2 (error)		
Load current	≤ 100 mA		
Leakage current	≤ 0.1 mA		
Logical AND connections	No. of connections: max. 4 units, no. of total connections: max. 20 units No. of layers: max. 5 layers, cable length: ≤ 100 m		
SFN connections ⁰⁶⁾	-	-	Max. 30 units
Approval	IEC/EN 61508 (SIL3), IEC/EN 62061 (SILCL3) IEC/EN 60947-5-1, EN ISO 13849-1 (Category 4, PLe) UL listed E249635		
Certification	CE                         		
Unit weight (package)	≈ 70 g (≈ 120 g)	≈ 90 g (≈ 140 g)	≈ 100 g (≈ 150 g)

01) Not include the power consumption of loads.

(SFC-N exclude the power supplied to the non-contact door switch.)

02) Includes a diagnostic pulse (max. 600 μs). Be cautious when using the output signal as an input signal for the control device.

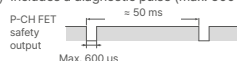



03) Available changing via setting switch on the back side of the product.

04) Available to set Off-delay time (max. 3 sec. / 300 sec., depends on model)

05) The operation (response) time of each model. The time increases when a logical connection or expansion relay unit is connected.

06) SFC-N units can only be connected to Autonics non-contact door switch units SFN Series.

Unit	Expansion relay	Relay		
Model	SFC-ER412-□	SFC-R412-□	SFC-R212-□	SFC-R212-R2□-□
Power supply	24 VDC≐			
Allowable voltage range	85 to 110% of rated voltage			
Power consumption ⁰¹⁾	≤ 2.5 W	≤ 4.0 W	≤ 4.0 W	≤ 6.0 W
Input	ON: ≥ 11 VDC≐ ≥ 5 mA, OFF: ≤ 5 VDC≐ ≤ 1 mA			
Input time	≥ 50 ms, feedback start (manual) : ≥ 100 ms			
Cable	≤ 100 m (≤ 100Ω, ≤ 10nF)			
Safety output	Relay (A contact)		Relay (A contact)	
Instantaneous	4 ×	4 ×	2 ×	2 ×
Off-delay ⁰²⁾	-	-	-	2 ×
Time accuracy	-	-	-	≤ ± 5%
Capacity	240 VAC~ 5 A resistance load, 30 VDC≐ 5 A resistance load			
Life expectancy	Mechanical: ≥ 10,000,000 operations, Malfunction: ≥ 50,000 operations			
Contact resistance	≤ 100 mΩ			
Inductive load switching	IEC60947-5-1: AC-15(230 V/2 A), DC-13(24 V/1.5 A), UL508: B300/R300			
Conditional short-circuit current	100 A ⁰³⁾			
Operating time (OFF → ON) ⁰⁴⁾	≤ 30 ms ⁰⁵⁾	≤ 100 ms		
Response (return) time (ON → OFF) ⁰⁴⁾	≤ 10 ms	≤ 15 ms		
Auxiliary output	1 × PNP transistor: X2 (error)	1 × PNP transistor: X1		
Load current	≤ 100 mA	≤ 100 mA		
Leakage current	≤ 0.1 mA			
Expansion units connections	Max. 5 units	-		
Approval	IEC/EN 61508 (SIL3), IEC/EN 62061 (SILCL3) IEC/EN 60947-5-1, EN ISO 13849-1 (Category 4, PLLe) UL listed E249635			
Certification	CE  EAC		CE  EAC	
Unit weight (package)	≈ 100 g (≈ 150 g)	≈ 110 g (≈ 160 g)	≈ 80 g (≈ 130 g)	≈ 110 g (≈ 150 g)

01) Not include the power consumption of loads.

02) Available to set Off-delay time (max. 3 sec. / 30 sec., depends on model)

03) Use 6 A fast-blow fuse under the IEC 60127 standard as a short-circuit protection device.

04) The operation (response) time of each model. The time increases when a logical connection or expansion relay unit is connected.

05) Except operation time of advanced unit, non-contact door switch unit

Pollution	3
Overvoltage category	III
Impulse withstand voltage for relay unit (IEC/EN 60947-5-1)	Input terminals and relay output terminals: 6 kV Relay contacts between 13-14 / 23-24 and 33-34 / 43-44 (37-38 / 47-48): 6 kV between 13-14 and 23-24: 4 kV between 33-34 and 43-44 (37-38 and 47-48): 4 kV
Dielectric strength	[Basic / Advanced / Non-contact door switch unit] Between all terminals and case: 500 VAC~ 50/60 Hz for 1 min. [Expansion relay / Relay unit] Between all terminals and case: 1,500 VAC~ 50/60 Hz for 1 min. Between input terminals and output terminals ⁰¹⁾ : 2,500 VAC~ 50/60 Hz for 1 min.
Insulation resistance	≥ 100 MΩ (500 VDC≐ megger)
Vibration ⁰²⁾	0.75 mm amplitude at frequency of 10 to 55 Hz (for 1 min) in each X, Y, Z direction for 1 hour
Vibration (malfunc.) ⁰²⁾	0.5 mm amplitude at frequency of 10 to 55 Hz (for 1 min) in each X, Y, Z direction for 10 minutes
Shock ⁰²⁾	300 m/s ² (≈ 30 G) in each X, Y, Z direction for 3 times
Shock (malfunc.) ⁰²⁾	100 m/s ² (≈ 10 G) in each X, Y, Z direction for 3 times
Protection rating	IP20 (IEC standard)
Ambient temperature	-10 to 55 °C, storage: -25 to 65 °C (no freezing or condensation)
Ambient humidity	25 to 85 %RH, storage: 25 to 85 %RH (no freezing or condensation)

01) In case of relay unit, output terminals between 13-14, 23-24 and 33-34, 43-44 (37-38, 47-48)

02) This data based on the product is mounted with bolts. When installing DIN rail, use the product in an environment with small vibration (condition: less than 0.4 mm double amplitude)

E. Controllers

Controllers are widely used in industrial control systems to adjust or maintain desired outputs of specific processes within a desired range.

- E1. Temperature Controllers
- E2. Digital Panel Meters
- E3. Digital Display Units
- E4. Sensor Controllers
- E5. Recorders
- E6. HMI
- E7. Counters
- E8. Timers
- E9. Industrial PC







E1. Temperature Controllers

Temperature controllers are used to identify measured temperature and release output to maintain desired temperatures.

E1-1	Panel Mount	TN Series	Two-Degree-of-Freedom PID Temperature Controllers
		TX Series	LCD PID Temperature Controllers
		TK Series	Simultaneous Heating & Cooling Output PID Temperature Controllers
		KPN Series	Bar Graph Temperature Controllers
		TCN Series	Dual Display PID Temperature Controllers
		TC Series	Single Display PID Temperature Controllers
		TA Series	Analog Non-Indication Type PID Temperature Controllers
		TF3 Series	Refrigeration Temperature Controllers
		TC3YF Series	Refrigeration Temperature Controllers
		TH4M Series	LCD Temperature / Humidity Controllers
		T3 / T4 Series	Thumbwheel Switch Temperature Controllers
		T3 / T4 Series	1-Channel Digital Temperature Indicators
		KN-1000B Series	Bar Graphic Temperature Indicators
		KN-2000W Series	1-Channel Digital Temperature Indicators
E1-2	DIN-Rail Mount	TMH Series	Modular 2 / 4-Channel PID Temperature Controllers with Screw Connector
		TM Series	Modular 2 / 4-Channel PID Temperature Controllers with Screwless Connector
		TR1D Series	Independent Single Display PID Temperature Controllers

Two-Degree-of-Freedom PID Temperature Controllers

TN Series



Features

- 2-DOF PID algorithm optimized for various control environments
- 50 ms high-speed sampling and $\pm 0.2\%$ display accuracy
- Program control and fixed control models available
 - Up to 10 patterns X 20 steps program setting (program control model)
 - Timer function for preset operation (fixed control model)
- Simultaneous heating / cooling and automatic / manual control function
- Control functions: Group PID, Zone PID, Anti Reset Windup (ARW)
- Control status monitoring of up to 10 events
- RS485 communication output model available
 - Communication protocols: Modbus RTU / ASCII, PLC ladderless, Sync-Master
 - Communication speed: up to 115,200bps
- Heater burnout alarm function (CT input)
- Parameter setting via PC
 - Comprehensive Device Management Software (DAQMaster) provided
 - Communication converter connection with front loader port (TNH, TNL only)
- Shortcut key setting with front user key button [U]
- Easy maintenance with detachable terminal blocks

Specifications

Power supply	100 - 240 VAC~, 50/60 Hz $\pm 10\%$	
Power consumption	≤ 8 VA	
Display type	11 segment, LCD type (operating value display part: 7 segment)	
Sampling period	50 / 100 / 250 ms (parameter)	
Input specification	Refer to Autonics website	
Option input	CT	• 0.0-50.0 A (primary current measurement range) • CT ratio: 1/1,000 • Measurement accuracy: $\pm 5\%$ F.S. ± 1 digit
	Digital	• Contact - ON: ≤ 2 k Ω , OFF: ≥ 90 k Ω • Non contact - residual voltage ≤ 1.0 V, leakage current ≤ 0.1 mA • Outflow current: ≈ 0.5 mA per input
Control output	Relay	250 VAC~ 3A 1a
	SSR	12 VDC $\approx \pm 2$ V, ≤ 20 mA
	Current	DC 0 - 20 mA or DC 4 - 20 mA (parameter), Load resistance: ≤ 500 Ω
Option output	Alarm	250 VAC~ 3 A 1a
	Transmission	DC 4 - 20 mA (load resistance: ≤ 500 Ω , output accuracy: $\pm 0.3\%$ F.S.)
	Communication	RS485
Control type	Type	ON/OFF, P, PI, PD, PID
	Multi SV	≤ 4 SV
	Group PID	≤ 8 group
	Zone PID	4 zones
	ARW (Anti Reset Windup)	50 to 200 %
Program control	Program	≤ 10 patterns
	Step	≤ 200 steps (1 pattern: ≤ 20 steps)
	Setting type	Time setting
Hysteresis	• Thermocouple, RTD: 1 to 100 (0.1 to 100.0) $^{\circ}\text{C}/^{\circ}\text{F}$ • Analog: 1 to 100 digit	
Proportional band (P)	0.1 to 999.9 $^{\circ}\text{C}$ (0.1 to 999.9%)	
Integral time (I)	0 to 9,999 sec	
Derivative time (D)	0 to 9,999 sec	
Control cycle (T)	• Relay / SSR output: 0.1 to 120.0 sec • Selectable current or SSR drive output: 1.0 to 120.0 sec	
Manual reset	0.0 to 100.0%	
Dielectric strength	Between the charging part and the case: 3,000 VAC~ 50/60 Hz for 1 min	
Vibration	0.75 mm amplitude at frequency of 5 to 55 Hz (for 1 min) in each X, Y, Z direction for 2 hours	
Relay life cycle	Mechanical	• OUT1/2: $\geq 5,000,000$ operations • AL1/2/3/4/5/6: $\geq 20,000,000$ operations
	Electrical	• OUT1/2: $\geq 200,000$ operations • AL1/2/3/4/5/6: $\geq 100,000$ operations
Insulation resistance	≥ 100 M Ω (500 VDC \approx megger)	
Insulation type	Double insulation or reinforced insulation (mark: \square), dielectric strength between the measuring input part and the power part: 3 kV)	
Noise immunity	± 2 kV square shaped noise by noise simulator (pulse width: 1 μs) R-phase, S-phase	
Memory retention	≈ 10 years (non-volatile semiconductor memory type)	
Ambient temperature	-10 to 50 $^{\circ}\text{C}$, storage: -20 to 60 $^{\circ}\text{C}$ (no freezing or condensation)	
Ambient humidity	35 to 85%RH	
Protection structure	IP65 (Front panel, IEC standards)	
Loader port	• TNS: top side	• TNH, TNL: front side
Accessory	Bracket	
Unit weight (packaged)	• TNS: ≈ 128 g (≈ 156 g) • TNH: ≈ 184 g (≈ 286 g) • TNL: TNL: ≈ 301 g (≈ 443 g)	
Approval	CE \cdot \cdot	
Comm. protocol	Modbus RTU/ASCII, Sync-Master, PLC ladderless	

LCD PID Temperature Controllers

TX Series



Features

- 50 ms high-speed sampling rate and $\pm 0.3\%$ display accuracy
- Large LCD display with easy-to-read white PV characters
- Switch between current output and SSR drive output
- SSR drive output (SSRP function) control options: ON / OFF control, cycle control, phase control
- Communication output model available: RS485 (Modbus RTU)
- Parameter configuration via PC (RS485 communication): DAQMaster software included (comprehensive device management software)
- Compact, space-saving design with 45 mm depth: 30% rear-length size reduction compared to similar-sized (48 × 48 mm) models from Autonics Terminal protection cover sold separately: RSA-COVER

*Korea Patent Registration 30-2020-0020300, Korea Patent Registration 10-1651262, U.S.A. Patent Registration 10281339, Japan Patent Registration 6603317, China Patent Registration ZL201580039398.2, Germany Patent Application 112015003239.8

*Korea Design Registration 30-0999138

Specifications

Series	TX Series	
Power supply	100 - 240 VAC~ 50/60 Hz $\pm 10\%$	
Power consumption	≤ 8 VA	
Sampling period	50 ms	
Input specification	Refer to Autonics website	
Control output	Relay	250 VAC~ 3 A, 30 VDC= 3 A, 1a
	SSR	TX4S: 12 VDC= ± 2 V, ≤ 20 mA TX4M/H/L: 13 VDC= ± 3 V, ≤ 20 mA
	Current	DC 4-20 mA or DC 0-20 mA (parameter), Load resistance: $\leq 500 \Omega$
Alarm output	Relay	AL1/2: 250 VAC~ 3 A 1a
Option output	PV transmission	DC 4 - 20 mA (Load resistance: $\leq 500 \Omega$, Output Accuracy: $\pm 0.3\%$ F.S.)
	RS485 Comm.	Modbus RTU
Display type	11 Segment (Red, Green, Yellow), LCD type	
Control type	Heating, Cooling	ON/OFF, P, PI, PD, PID Control
	Heating& Cooling	
Hysteresis	1 to 100 (0.1 to 50.0) °C/°F	
Proportional band (P)	0.1 to 999.9 °C/°F	
Integral time (I)	0 to 9,999 sec	
Derivative time (D)	0 to 9,999 sec	
Control cycle (T)	0.5 to 120.0 sec	
Manual reset	0.0 to 100.0%	
Relay life cycle	Mechanical	$\geq 5,000,000$ operations
	Electrical	$\geq 200,000$ operations (resistance load: 250 VAC~ 3 A)
Dielectric strength	Between all terminals and case: 3,000 VAC~ 50/60 Hz for 1 min	
Vibration	0.75 mm amplitude at frequency 5 to 55Hz (for 1 min) in each X, Y, Z direction for 2 hours	
Insulation resistance	$\geq 100 \text{ M}\Omega$ (500 VDC= megger)	
Noise immunity	± 2 kV square shaped noise (pulse width 1 μ s) by noise simulator R-phase, S-phase	
Memory retention	≈ 10 years (non-volatile semiconductor memory type)	
Ambient temperature	-10 to 50 °C, storage: -20 to 60 °C (no freezing or condensation)	
Ambient humidity	35 to 85%RH, storage: 35 to 85%RH (no freezing or condensation)	
Protection structure	IP50 (Front panel, IEC standards)	
Insulation type	Double or reinforced insulation (mark: \square), dielectric strength between primary circuit and secondary circuit: 3 kV)	
Approval	CE, RoHS, ENEC	
Unit weight (packaged)	• TX4S: ≈ 87 g (≈ 146 g) • TX4M: ≈ 143 g (≈ 233 g) • TX4H: ≈ 133 g (≈ 214 g) • TX4L: ≈ 206 g (≈ 290 g)	
Comm. protocol	Modbus RTU	

01) When using the unit at low temperature (below 0°C), display cycle is slow.

Simultaneous Heating & Cooling Output PID Temperature Controllers

TK Series



Features

- 50 ms high-speed sampling rate and $\pm 0.3\%$ display accuracy
- Simultaneous heating and cooling control function
- Switch between current output and SSR drive output
- SSR drive output (SSRP function) control options:
ON / OFF control, cycle control, phase control
- Communication output models available:
RS485 (Modbus RTU)
- Parameter configuration via PC (RS485 communication)
- DAQMaster software included (comprehensive device management software)
- Communication converter sold separately:
SCM-US (USB to serial converter),
SCM-38I (RS-232C to RS485 converter),
SCM-US48I (USB to RS485 converter)
- User-friendly parameter features
- Heater disconnect alarm function (CT input)
- Current transformer (CT) sold separately:
CSTC-E80LN, CSTC-E200LN, CSTS-E80PP
- SV preset function (up to 4 set values) using digital input terminals
- Available in various DIN sizes:
48 × 24, 48 × 48, 72 × 72, 96 × 48, 48 × 96,
96 × 96 mm

Specifications

Series	TK4N	TK4SP	TK4S	TK4M
Power supply	AC type	100 - 240 VAC ~ 50/60 Hz $\pm 10\%$		
	AC/DC type	-	24 VAC ~ 50/60 Hz $\pm 10\%$, 24-48 VDC $\pm 10\%$	
Power consumption	AC type	≤ 6 VA	≤ 8 VA	-
	AC/DC type	-	AC: ≤ 8 VA, DC: ≤ 5 W	
Unit weight (packaged)	≈ 70 g (≈ 140 g)	≈ 85 g (≈ 130 g)	≈ 105 g (≈ 150 g)	≈ 140 g (≈ 210 g)
Series	TK4W	TK4H	TK4L	
Power supply	AC type	100 - 240 VAC ~ 50/60 Hz $\pm 10\%$		
	AC/DC type	24 VAC ~ 50/60 Hz $\pm 10\%$, 24-48 VDC $\pm 10\%$		
Power consumption	AC type	≤ 8 VA		
	AC/DC type	AC: ≤ 8 VA, DC: ≤ 5 W		
Unit weight (packaged)	≈ 141 g (≈ 211 g)	≈ 141 g (≈ 211 g)	≈ 198 g (≈ 294 g)	
Sampling period	50 ms			
Input specification	Refer to Autonics website			
Option input	CT input	• 0.0-50.0 A (primary current measurement range) • CT ratio: 1/1,000 • Measurement accuracy: $\pm 5\%$ F.S. ± 1 digit		
	Digital input	• Contact - ON: ≤ 2 k Ω , OFF: ≥ 90 k Ω • Non contact - residual voltage ≤ 1.0 V, leakage current ≤ 0.1 mA • Outflow current: ≈ 0.5 mA per input		
Control output	Relay	250 VAC ~ 3 A, 30 VDC ≈ 3 A 1a		
	SSR	11 VDC $\approx \pm 2$ V, ≤ 20 mA		
Alarm output	Relay	AL1, AL2: 250 VAC ~ 3 A 1a • TK4N AL2: 250 VAC ~ 0.5 A 1a (≤ 125 VA)		
	Current	DC 4-20 mA or DC 0-20 mA (parameter), Load resistance: ≤ 500 Ω		
Option output	Transmission	DC 4 - 20 mA (Load resistance: ≤ 500 Ω , Output accuracy: $\pm 0.3\%$ F.S.)		
Option output	RS485 comm.	Modbus RTU		
Display type	7 segment (red, green, yellow), LED type			
Control type	Heating, Cooling	ON/OFF, P, PI, PD, PID Control		
	Heating & Cooling			
Hysteresis	• Thermocouple, RTD: 1 to 100 (0.1 to 100.0) $^{\circ}\text{C}/^{\circ}\text{F}$ • Analog: 1 to 100 digit			
Proportional band (P)	0.1 to 999.9 $^{\circ}\text{C}/^{\circ}\text{F}$ (0.1 to 999.9%)			
Integral time (I)	0 to 9,999 sec			
Derivative time (D)	0 to 9,999 sec			
Control cycle (T)	• Relay output, SSR drive output: 0.1 to 120.0 sec • Selectable current or SSR drive output: 1.0 to 120.0 sec			
Manual reset	0.0 to 100.0%			
Relay life cycle	Mechanical	OUT1/2: $\geq 5,000,000$ operations AL1/2: $\geq 20,000,000$ operations (TK4H/W/L: $\geq 5,000,000$ operations)		
	Electrical	$\geq 100,000$ operations		
Dielectric strength	Between power source terminal and input terminal: 2,000 VAC ~ 50/60 Hz for 1 min			
Vibration	0.75 mm amplitude at frequency of 5 to 55 Hz (for 1 min) in each X, Y, Z direction for 2 hours			
Insulation resistance	≥ 100 M Ω (500 VDC \approx megger)			
Noise immunity	± 2 kV square shaped noise by noise simulator (pulse width: 1 μs) R-phase, S-phase			
Memory retention	≈ 10 years (non-volatile semiconductor memory type)			
Ambient temperature	-10 to 50 $^{\circ}\text{C}$, storage: -20 to 60 $^{\circ}\text{C}$ (no freezing or condensation)			
Ambient humidity	35 to 85%RH, storage: 35 to 85%RH (no freezing or condensation)			
Protection structure	IP65 (Front panel, IEC standards) • TK4SP: IP50 (Front panel, IEC standards)			
Insulation type	Double insulation or reinforced insulation (mark: \square), dielectric strength between the measuring input part and the power part: 2 kV			
Accessory	Bracket, Terminal protection cover (TK4N)			
Approval	CE,  , ENEC			
Comm. protocol	Modbus RTU			

Bar Graph Temperature Controllers

KPN Series



Features

- High speed sampling of 50 ms and $\pm 0.3\%$ display accuracy
- Enable to check control output operation amount by adopting bar graph
- Simultaneous heating / cooling control and automatic / manual control for high performance control
- Selection function of current output or SSR drive output
- Parameter setting available via PC (USB and RS485 communication)
 - Free device comprehensive management program (DAQMaster)
- Communication converter sold separately:
 - SCM-US (USB / Serial converter),
 - SCM-38I (RS232C / RS485 converter),
 - SCM-US48I (USB / RS485 converter)
- Multi-SV (Max. 4) function (select via digital input terminal)
- Heater break alarm
- CT sold separately:
 - CSTC-E80LN, CSTC-E200LN, CSTS-E80PP
- Small size (rear length: 60 mm)
- Multi input / multi range

Specifications

Series		KPN Series
Power supply		100 - 240 VAC~ 50/60 Hz
Power consumption		≤ 15 VA
Sampling period		50 ms
Input specification		Refer to Autonics website
Option input	CT input	• 0.0-50.0 A (primary current measurement range) • CT ratio: 1/1,000
	Remote SV	1 - 5 VDC \equiv or 4 - 20 mA (Current Input: External resistance 250 Ω)
	Digital input	• Contact - ON: ≤ 2 k Ω , OFF: ≥ 90 k Ω • Non contact - residual voltage ≤ 1.0 V, leakage current ≤ 0.1 mA
Control output	Relay	250 VAC~ 5 A 1a
	SSR	11 VDC \equiv ± 2 V, ≤ 20 mA
	Current	DC 4-20 mA or DC 0-20 mA (parameter), load resistance: ≤ 500 Ω
Alarm output	Relay	250 VAC~ 3 A 1a
Option output	Transmission	DC 4 - 20 mA (load resistance: ≤ 500 Ω , output accuracy: $\pm 0.3\%$ F.S. ± 1 -digit)
	RS485 Comm.	Modbus RTU
Display type		7 segment (red, green), control output bar graph (red, green), LED type
Control type	Heating, Cooling	ON/OFF, P, PI, PD, PID Control
	Heating & Cooling	
Hysteresis		• Thermocouple, RTD: 1 to 100 (0.1 to 100.0) $^{\circ}\text{C}/^{\circ}\text{F}$ • Analog: 1 to 100 digit
Proportional band (P)		0.1 to 999.9 $^{\circ}\text{C}/^{\circ}\text{F}$ (0.1 to 999.9%)
Integral time (I)		0 to 9,999 sec
Derivative time (D)		0 to 9,999 sec
Control cycle (T)		• 0.1 to 120.0 sec [relay output model] • 1.0 to 120.0 sec [SSR drive output model]
Manual reset		0.0 to 100.0%
Relay life cycle	Mechanical	$\geq 10,000,000$ operations
	Electrical	$\geq 100,000$ operations (load resistance: 250 VAC~ 3 A)
Dielectric strength		Between power source terminal and input terminal: 2,000 VAC~ 50/60 Hz for 1 min
Vibration		0.75 mm amplitude at frequency of 5 to 55 Hz (for 1 min) in each X, Y, Z direction for 2 hours
Insulation resistance		≥ 100 M Ω (500 VDC \equiv megger)
Noise immunity		± 2 kV square shaped noise (pulse width 1 μs) by noise simulator R-phase, S-phase
Memory retention		≈ 10 years (non-volatile semiconductor memory type)
Ambient temperature		-10 to 50 $^{\circ}\text{C}$, storage: -20 to 60 $^{\circ}\text{C}$ (no freezing or condensation)
Ambient humidity		35 to 85%RH, storage: 35 to 85%RH (no freezing or condensation)
Protection structure		IP65 (front panel, IEC standards)
Insulation type		Double or reinforced insulation (mark: \square), dielectric strength between the measuring input part and the power part: 2 kV)
Accessory		Bracket
Approval		CE ENEC
Unit weight (packaged)		• KPN52 \square - \square : ≈ 160 g (≈ 230 g) • KPN53 \square - \square : ≈ 160 g (≈ 230 g) • KPN55 \square - \square : ≈ 220 g (≈ 316 g)
Comm. protocol		Modbus RTU

Dual Display PID Temperature Controllers

TCN Series





Features

- Dual digital display (PV / SV)
- 100 ms high-speed sampling rate and $\pm 0.5\%$ display accuracy
- Switch between relay output and SSR drive output
- SSR drive output (SSRP function) control options: ON / OFF control, cycle control, phase control
- Compact design with large display panels for easier reading
- Connector plug types offer easier wiring and maintenance (TCN4S-□-P)

*Korea Patent Registration 10-1002582, U.S.A. Patent Registration 8645000, Japan Patent Registration 3184816, China Patent Registration ZL200980111733.X, Vietnam Patent Registration 1-0012131, India Patent Registration 291573, Indonesia Patent Registration IDP0032166

Specifications

Series	TCN4□-22□-□	TCN4□-24□-□
Power supply	24 VAC~ 50/60 Hz $\pm 10\%$ 24 - 48 VDC $\pm 10\%$	100 - 240 VAC~ 50/60 Hz $\pm 10\%$
Power consumption	AC: ≤ 5 VA, DC: ≤ 3 W	≤ 5 VA
Sampling period	100 ms	
Input specification	Refer to Autonics website	
Control output	Relay	250 VAC~ 3A, 30 VDC ≤ 3 A, 1a
	SSR	12 VDC ± 2 V, ≤ 20 mA
Alarm output	250 VAC~ 1 A 1a	
Display type	7 Segment (red, green), LED type	
Control type	Heating, Cooling ON/OFF, P, PI, PD, PID Control	
Hysteresis	1 to 100 (0.1 to 50.0) °C/°F	
Proportional band (P)	0.1 to 999.9 °C/°F	
Integral time (I)	0 to 9,999 sec	
Derivative time (D)	0 to 9,999 sec	
Control cycle (T)	0.5 to 120.0 sec	
Manual reset	0.0 to 100.0%	
Relay life cycle	Mechanical	$\geq 5,000,000$ operations
	Electrical	OUT1/2: $\geq 200,000$ operations (load resistance: 250 VAC~ 3 A) AL1/2: $\geq 300,000$ operations (load resistance: 250 VAC~ 1 A)
Dielectric strength	Between input terminal and power terminal: 1,000 VAC~ 50/60 Hz for 1 min	Between input terminal and power terminal: 2,000 VAC~ 50/60 Hz for 1 min
Vibration	0.75 mm amplitude at frequency of 5 to 55 Hz (for 1 min) in each X, Y, Z direction for 2 hours	
Insulation resistance	≥ 100 M Ω (500 VDC \equiv megger)	
Noise immunity	± 2 kV square shaped noise (pulse width: 1 μ s) by noise simulator R-phase, S-phase	
Memory retention	≈ 10 years (non-volatile semiconductor memory type)	
Ambient temperature	-10 to 50 °C, storage: -20 to 60 °C (no freezing or condensation)	
Ambient humidity	35 to 85%RH, storage: 35 to 85%RH (no freezing or condensation)	
Insulation type	Mark: □, double or reinforced insulation (dielectric strength between the measuring input part and the power part: 1 kV)	Mark: □, double or reinforced insulation (dielectric strength between the measuring input part and the power part: 2 kV)
Approval	CE  ENEC 	
Unit weight (packaged)	• TCN4S: ≈ 100 g (≈ 147 g) • TCN4M: ≈ 133 g (≈ 203 g) • TCN4H: ≈ 124 g (≈ 194 g) • TCN4L: ≈ 179 g (≈ 275 g)	

Single Display PID Temperature Controllers

TC Series



Features

- Single digital display (switch between PV and SV)
- 100 ms high-speed sampling rate and $\pm 0.5\%$ display accuracy
- Switch between relay output and SSR drive output
- SSR drive output (SSRP function) control options: ON / OFF control, cycle control, phase control
- Compact design with large display panels for easier reading
- Connector plug types offer easier wiring and maintenance (TCN4S-□-P)

Specifications

Series	TC4□-□2□	TC4□-□4□
Power supply	24 VAC~ 50/60 Hz $\pm 10\%$ 24-48 VDC $\pm 10\%$	100 - 240 VAC~ 50/60 Hz $\pm 10\%$
Power consumption	AC: ≤ 5 VA, DC: ≤ 3 W	≤ 5 VA
Sampling period	100 ms	
Input specification	Refer to Autonics website	
Control output	Relay	250 VAC~ 3 A, 30 VDC ≤ 3 A, 1a
	SSR	12 VDC ± 2 V, ≤ 20 mA
Alarm output	250 VAC~ 1 A 1a	
Display type	7 Segment (red, green, yellow), LED type	
Control type	Heating	ON/OFF, P, PI, PD, PID Control
	Cooling	
Hysteresis	1 to 100 (0.1 to 50.0) °C/°F	
Proportional band (P)	0.1 to 999.9 °C/°F	
Integral time (I)	0 to 9,999 sec	
Derivative time (D)	0 to 9,999 sec	
Control cycle (T)	0.5 to 120.0 sec	
Manual reset	0.0 to 100.0%	
Relay life cycle	Mechanical	OUT1/2, AL1/2: $\geq 5,000,000$ operations
	Electrical	OUT1/2: $\geq 200,000$ operations (load resistance: 250 VAC~ 3A) AL1/2: $\geq 300,000$ operations (load resistance: 250 VAC~ 1 A)
Dielectric strength	Between input terminal and power terminal: 1,000 VAC~ 50/60 Hz for 1 min	Between input terminal and power terminal: 2,000 VAC~ 50/60 Hz 1 min
Vibration	0.75 mm amplitude at frequency 5 to 55Hz (for 1 min) in each X, Y, Z direction for 2 hours	
Insulation resistance	≥ 100 M Ω (500 VDC \equiv megger)	
Noise immunity	Square shaped noise (pulse width: 1 μ s) by noise simulator ± 2 kV R-phase, S-phase	
Memory retention	≈ 10 years (non-volatile semiconductor memory type)	
Ambient temperature	-10 to 50 °C, storage: -20 to 60 °C (no freezing or condensation)	
Ambient humidity	35 to 85%RH, storage: 35 to 85%RH (no freezing or condensation)	
Insulation type	Mark: □, double or reinforced insulation (dielectric strength between the measuring input part and the power part: 1 kV)	Mark: □, double or reinforced insulation (dielectric strength between the measuring input part and the power part: 2 kV)
Approval	CE ENEC	
Unit weight (packaged)	• TC4S: ≈ 94 g (≈ 141 g) • TC4SP: ≈ 76 g (≈ 123 g) • TC4Y: ≈ 85 g (≈ 174 g) • TC4M: ≈ 133 g (≈ 204 g) • TC4W: ≈ 122 g (≈ 194 g) • TC4H: ≈ 122 g (≈ 194 g) • TC4L: ≈ 155 g (≈ 254 g)	

Analog Non-Indication Type PID Temperature Controllers

TA Series



Features

- Auto-tuning PID temperature control
- PID and ON / OFF control: toggle via external switch
- Deviation indicators (green, red LED)
- Control output indicator (red LED)
- Stop control output function using analog dial
- Sensor disconnect display function
- Built-in microprocessor

Specifications

Series	TA Series	
Power supply	100 - 240 VAC ~ 50/60 Hz ±10%	
Power consumption	≤ 4 VA	
Sampling period	100 ms	
Input specification	<ul style="list-style-type: none"> • RTD: DPt100Ω (allowable line resistance per a wire: ≤5 Ω) • Thermocouple: K (CA), J (IC) 	
Control output	Relay	250 VAC ~ 3 A, 30 VDC = 1 A 1c
	SSR	12 VDC = ±2 V, ≤ 20 mA
Display type	PV deviation, Error display (red, green), LED type	
Setting method	Front dial	
Setting accuracy	<ul style="list-style-type: none"> • At room temperature (23 °C ±5 °C) Over 100 °C model: F.S.±2%, below 100 °C model: F.S.±3% • Out of room temperature range Over 100 °C model: F.S.±3%, below 100 °C model: F.S.±4% 	
Control type	ON / OFF	Hysteresis: 2°C (fixed)
	PID Control	Control cycle: relay output 20 sec / SSR drive output 2 sec
Relay life cycle	Mechanical	≥ 10,000,000 operations (18,000 operations/time)
	Electrical	≥ 100,000 operations (900 operations/time)
Dielectric strength	Between input terminal and power terminal: 2,000 VAC ~ 50/60 Hz for 1 min	
Vibration	0.75 mm amplitude at frequency of 5 to 55 Hz (for 1 min) in each X, Y, Z direction for 2 hours	
Insulation resistance	≥ 100 MΩ (500 VDC = megger)	
Noise immunity	Square shaped noise (pulse width: 1 μs) by noise simulator ±2 kV R-phase, S-phase	
Memory retention	≈ 10 years (non-volatile semiconductor memory type)	
Ambient temperature	-10 to 50 °C, storage: -20 to 60 °C (no freezing or condensation)	
Ambient humidity	35 to 85%RH, storage: 35 to 85%RH (no freezing or condensation)	
Insulation type	Double or reinforced insulation (mark: □), dielectric strength between the measuring input part and the power part: 2 kV)	
Approval	CE cULus ERI	
Unit weight (packaged)	• TAS: ≈ 69 g (≈ 107 g) • TAM: ≈ 109 g (≈ 171 g) • TAL: ≈ 147 g (≈ 232 g)	

Refrigeration Temperature Controllers

TF3 Series



Features

- Standard installation size for refrigeration panels (W 70.3 × H 28.2mm)
- Various compressor load current capacity: 5 A, 16 A, 20 A
- Various user-friendly functions
 - Defrost sync function : simultaneous defrost operation of multiple controllers (up to 6 units)
 - RTC (Real Time Clock) function : night mode operation and real-time defrost control
 - Built-in alarm function
- Remote monitoring of real-time temperature and output control (using TFD series remote display unit, sold separately)
- Communication output models available: RS485 (Modbus RTU)
- Parameter configuration via PC (RS485 communication): DAQMaster software included (comprehensive device management software)
- IP65 protection structure (IEC standard): front panel only

Specifications

Series		TF3 Series
Power supply	AC	100 - 240 VAC~ 50/60 Hz ±10%
	AC / DC	24 VAC~ 50/60 Hz ±10%, 12-24 VDC== ±10%
Power consumption	AC	≤ 8 VA
	AC / DC	AC: ≤ 5 VA, DC: ≤ 3 W
Sampling period		500 ms
Input specification		Refer to Autonics website
Option input	Digital input	• Contact - ON: ≤ 1 kΩ, OFF: ≥ 100 kΩ • Non contact - residual voltage ≤ 1 V, leakage current ≤ 1 mA Outflow current: = 4 uA
	Control output	Compressor (COMP) 250 VAC~ 5 A / 30 VDC== 5 A / 1a 250 VAC~ 16 A / 24 VDC== 16 A / 1c 250 VAC~ 20 A 1a Defrost (DEF) 250 VAC~ 10 A / 24 VDC== 10 A / 1a Auxiliary (AUX) 250 VAC~ 5 A / 30 VDC== 5 A / 1a
RS485 communication		Modbus RTU
Display type		7 segment (red), LED type
Control type		ON/OFF Control
Hysteresis		0.5 to 5.0 °C, 2 to 10 °F
Relay life cycle	Mechanical	• COMP (5 A 1a), AUX: ≥ 5,000,000 operations • COMP (16 A 1c), DEF: ≥ 20,000,000 operations • COMP (20 A 1a): ≥ 10,000,000 operations
	Electrical	• COMP (5 A 1a), AUX: ≥ 50,000 operations (load resistance: 250 VAC~ 5 A) • COMP (16 A 1c): ≥ 30,000 operations (load resistance: 250 VAC~ 16 A) • COMP (20 A 1a): ≥ 100,000 operations (load resistance: 250 VAC~ 20 A) • DEF: ≥ 100,000 operations (load resistance: 250 VAC~ 10 A)
Dielectric strength	AC	Between all terminals and case, power and input circuit: 3,000 VAC~ 50 / 60 Hz for 1 min
	AC / DC	Between all terminals and case, power and input circuit: 1,000 VAC~ 50 / 60 Hz for 1 min
Vibration		1.5 mm amplitude at frequency of 10 to 55 Hz (for 1 min) in each X, Y, Z direction for 2 hours
Insulation resistance		≥ 100 MΩ (500 VDC== megger)
Noise immunity		Square shaped noise by noise simulator (pulse width 1 μs) ±2 kV R-phase, S-phase
Memory retention		≈ 10 years (non-volatile semiconductor memory type)
Ambient temperature		-10 to 50 °C, storage: -20 to 60 °C (no freezing or condensation)
Ambient humidity		35 to 85%RH, storage: 35 to 85%RH (no freezing or condensation)
Protection structure		IP65 (front panel, IEC standards)
Approval		CE :RoHS== ENEC
Unit weight (packaged)		≈ 105 g (≈ 207 g)
Comm. protocol		Modbus RTU

Refrigeration Temperature Controllers

TC3YF Series



Features

- ON / OFF control
- Standard input type: thermistor (NTC)
 - RTD (Pt100Ω) input models available upon request.
- Temperature range
 - Thermistor (NTC): -40.0 to 99.9 °C -40 to 212 °F)
 - RTD (Pt100 Ω): -99.9 to 99.9 °C (-148 to 212 °F)
- Various functions available for optimal cooling control
 - Auto / manual defrost selection, compressor start-up delay, restart delay, minimum ON time, end-defrost delay, evaporator fan operation delay
- Input correction function
- Operation cycle programming available to protect contents in case of error

Specifications

Series		TC3YF Series
Power supply	AC	100 - 240 VAC~ 50/60 Hz
	DC	12-24 VDC==
Allowable voltage range		90 to 110% of rated voltage
Power consumption	AC	≤ 4 VA
	DC	≤ 8 W
Sampling period		500 ms
Input specification		Refer to Autonics website
Display accuracy		At room temperature (23 ±5 °C): (PV ±0.5% or 1 °C higher one) rdg ±1 digit Out of room temperature range: (PV ±0.5% or 1 °C higher one) rdg ±1 °C
Control output	Compressor (COMP)	250 VAC~ 5 A 1a, 30 VDC== 5 A 1a
	Defrost (DEF)	250 VAC~ 10 A 1a
	Evaporation-fan (FAN)	250 VAC~ 5 A 1a, 30 VDC== 5 A 1a
Display type		7 segment (red), LED type
Control type		ON/OFF Control
Hysteresis		0.5 to 5.0 °C, 2 to 50 °F
Relay life cycle	Mechanical	≥ 20,000,000 operations
	Electrical	• COMP, DEF: ≥ 50,000 operations (load resistance: 250 VAC~ 5 A) • FAN ≥ 100,000 operations (load resistance: 250 VAC~ 10 A)
Dielectric strength		Between all external terminals and case: 2,000 VAC~ 60 Hz for 1 min
Vibration		0.75 mm amplitude at frequency of 10 to 55Hz (for 1 min) in each X, Y, Z direction for 2 hours
Malfunction vibration		0.5mm amplitude at frequency of 10 to 55Hz (for 1 min) in each X, Y, Z direction for 10 min
Insulation resistance		≥ 100 MΩ (500 VDC== megger)
Noise immunity	AC	±2 kV square shaped noise (pulse width 1 μs) by noise simulator R-phase, S-phase
	DC	±500 V square shaped noise (pulse width 1 μs) by noise simulator R-phase, S-phase
Memory retention		≈ 10 years (non-volatile semiconductor memory type)
Ambient temperature		-10 to 50 °C, storage: -20 to 60 °C (no freezing or condensation)
Ambient humidity		35 to 85%RH, storage: 35 to 85%RH (no freezing or condensation)
Protection structure		IP65 (Front panel, IEC standards)
Approval	AC	UL, CE, ENEC (Except RTD option models) ENEC
	DC	UL, CE
Unit weight (packaged)		≈ 143 g (= 229 g)

LCD Temperature / Humidity Controllers

TH4M Series



Features

- Simultaneous control of temperature and humidity
- LCD display with easy-to-read white and blue characters
- Input correction of temperature and humidity
- Output delay time setting
- Deviation high / low-limit alarm output
- Dedicated temperature / humidity sensor THD-RM (accessory)

Specifications

Model	TH4M-24R	
Power supply	100 - 240 VAC ~ 50/60 Hz ±10%	
Power consumption	≤ 8 VA	
Sampling period	1 sec	
Display accuracy	Temperature	• At room temperature (25 °C ±5 °C): ≤ ±1.0 °C • Out of room temperature range: ≤ ±2.0 °C
	Humidity	• At room temperature (25 °C ±5 °C): ≤ ±3.0%RH (20 to 90%RH), ≤ ±5.0%RH (below 20%RH, over 90%RH) • Out of room temperature: ≤ ±5.0%RH (all range)
Display range	Temperature	-20.0 to 60.0 °C
	Humidity	10.0 to 100.0%RH
Using range	Temperature	-20.0 to 60.0 °C
	Humidity	10.0 to 100.0%RH
Control output ⁰¹⁾	Temperature (OUT1)	Relay: 250 VAC ~ 3 A, 30 VDC = 3 A, 1a
	Humidity (OUT2)	Relay: 250 VAC ~ 3 A, 30 VDC = 3 A, 1a
Alarm output	Relay	AL1/2: 250 VAC ~ 3 A, 1a
Display type ⁰²⁾	11-Segment (temperature: white, humidity: blue), other display (yellow) LCD type	
Control type	ON/OFF control	
Relay life cycle	Mechanical	≥ 5,000,000 operations
	Electrical	≥ 200,000 operations (resistance load: 250 VAC ~ 3 A)
Dielectric strength	Between primary circuit and secondary circuit: 3,000 VAC ~ 50/60 Hz for 1 min	
Vibration	0.75 mm amplitude at frequency 5 to 55Hz (for 1 min) in each X, Y, Z direction for 2 hours	
Insulation resistance	≥ 100 MΩ (500 VDC = megger)	
Noise immunity	±2 kV square shaped noise (pulse width 1 μs) by noise simulator R-phase, S-phase	
Memory retention	≈ 10 years (non-volatile semiconductor memory type)	
Ambient temperature	-10 to 50 °C, storage: -20 to 60 °C (no freezing or condensation)	
Ambient humidity	35 to 85%RH, storage: 35 to 85%RH (no freezing or condensation)	
Insulation type	Double or reinforced insulation (mark: □, dielectric strength between primary circuit and secondary circuit: 3 kV)	
Approval	CE	
Unit weight	≈ 144 g	

01) Connect to a load using the same power supply. Connecting to a load from a different power supply may cause safety issues.
02) When using the unit at low temperature (below 0°C), display cycle is slow.

Next Page ►

[Temperature / Humidity sensor]

Model		THD-RM
Power supply		3.3 VDC \pm 2%
Power consumption		\leq 1.3mA
Response time		15 sec
Sensing accuracy	Temperature	<ul style="list-style-type: none"> At room temperature (25 °C \pm5 °C): \leq \pm1.0 °C Out of room temperature: \leq \pm2.0 °C
	Humidity	<ul style="list-style-type: none"> At room temperature (25 °C \pm5 °C): \leq \pm3.0%RH (20 to 90%RH), \leq \pm5.0%RH (below 20%RH, over 90%RH) Out of room temperature: \leq \pm5.0%RH (all range)
Sensing range	Temperature	-20.0 to 60.0 °C
	Humidity	10.0 to 100.0%RH
Communication type		I2C communication output
Dielectric strength		Between primary circuit and case: 500 VAC \sim 50/60 Hz for 1 min
Vibration		0.75 mm amplitude at frequency 5 to 55Hz (for 1 min) in each X, Y, Z direction for 2 hours
Ambient temperature		-20 to 60 °C, storage: -20 to 60 °C (no freezing or condensation)
Ambient humidity		0 to 100%RH, storage: 35 to 85%RH (no freezing or condensation)
Cable		\varnothing 4 mm, 4 seam, 2 m (tensile strength: 1kgf/s)
Approval		CE
Unit weight		\approx 56 g

Thumbwheel Switch Temperature Controllers

T3 / T4 Series



Features

- Various control output options: relay, SSR drive, current
- 2 independent set points and control outputs for heating and cooling control (T4LP)
- Various sizes (W 48 × H 48, W 48 × H 96, W 72 × H 72, W 96 × H 96 mm)

Specifications

Series		T3/T4 Series
Power supply		100 - 240 VAC~ 50/60 Hz ±10%
Power consumption		≤ 5 VA
Sampling period		100 ms
Input specification		Refer to Autonics website
Display accuracy ⁰¹⁾		<ul style="list-style-type: none"> • At room temperature (23 °C ±5 °C): (PV ±0.5% or ±1°C higher one) ±1 digit • Out of room temperature range: (PV ±0.5% or ±2 °C higher one) ±1 digit
Control output	Relay ⁰²⁾	OUT1: 250 VAC~ 5 A / 30 VDC≡ 5A 1c, OUT2: 250 VAC~ 2 A / 30 VDC≡ 2A 1c
	SSR	12 VDC≡±2 V, ≤ 20 mA
	Current	DC 4-20 mA, Load resistance: ≤ 500 Ω
Option output		250 VAC~ 2 A 1c
Alarm output setting range		F.S. 0 to 10% (volume switch)
Option output setting range		0 to 50 °C (volume switch)
Reset range		F.S. -3 to 3% (volume switch)
Display type		7 segment (red), LED type
Control type		ON/OFF, Proportional control
Hysteresis		F.S. 0.2 to 3% (T3S: F.S. 0.5%) (volume switch)
Proportional band		F.S. 1 to 10% (T3S: F.S. 3%) (volume switch)
Proportional cycle		20 sec
Relay life cycle	Mechanical	≥ 5,000,000 operations
	Electrical	OUT1: ≥ 100,000 operations, OUT2: ≥ 200,000 operations
Dielectric strength		Between input terminal and power terminal: 2,000 VAC~ 50/60 Hz for 1 min
Vibration		0.75 mm amplitude at frequency of 10 to 55 Hz (for 1 min) in each X, Y, Z direction for 2 hours
Insulation resistance		≥ 100 MΩ (500 VDC≡ megger)
Noise immunity		±2 kV square shaped noise by noise simulator (pulse width 1 μs) R-phase, S-phase
Memory retention		≈ 10 years (non-volatile semiconductor memory type)
Ambient temperature		-10 to 50 °C, storage: -20 to 60 °C (no freezing or condensation)
Ambient humidity		35 to 85%RH, storage: 35 to 85%RH (no freezing or condensation)
Approval		ERL
Unit weight (packaged)		<ul style="list-style-type: none"> • T3S: ≈ 95 g (≈ 135 g) • T3H, T3HA, T3HS: ≈ 176 g (≈ 239 g) • T4M, T4MA: ≈ 180 g (≈ 246 g) • T4L, T4LA, T4LP: ≈ 222 g (≈ 310 g)

01) In case of the T3S Series and the decimal point display models

At room temperature (23 °C ±5 °C): (PV ±0.5% or ±2 °C higher one) ±1 digit

Out of room temperature range: (PV ±0.5% or ±3 °C higher one) ±1 digit

02) Dual setting output of the T4LP is fixed as relay output and, it is also available as alarm output.

1-Channel Digital Temperature Indicators

T3 / T4 Series



Features

- Various control output options : relay, SSR drive, current
- 2 independent set points and control outputs for heating and cooling control (T4LP)
- Various sizes (W 48 × H48, W 48 × H 96, W 72 × H 72, W 96 × H 96 mm)

Specifications

Series	T3/T4 Series
Power supply	100 - 240 VAC~ 50/60 Hz ±10% (T3NI: 12-24 VDC±= ±10%)
Power consumption	≤ 5 VA (T3NI: ≤ 1 W)
Input specification	Refer to Autonics website
Display accuracy ⁰¹⁾	<ul style="list-style-type: none"> • At room temperature (23 °C ±5 °C): (PV ±0.5% or ±1°C higher one) ±1 digit • Out of room temperature range: (PV ±0.5% or ±2 °C higher one) ±1 digit
Display type	7 Segment (red), LED type
Dielectric strength	Between input terminal and power terminal: 2,000 VAC~ 50/60 Hz for 1 min
Vibration	0.75 mm amplitude at frequency of 10 to 55 Hz (for 1 min) in each X, Y, Z direction for 2 hours
Insulation resistance	≥ 100 MΩ (500 VDC= megger)
Noise immunity	±2 kV square shaped noise (pulse width 1 μs) by noise simulator R-phase, S-phase
Ambient temperature	-10 to 50 °C, storage: -20 to 60 °C (no freezing or condensation)
Ambient humidity	35 to 85%RH, storage: 35 to 85%RH (no freezing or condensation)
Accessory	Bracket
Approval	ERC
Unit weight (packaged)	<ul style="list-style-type: none"> • T3NI: ≈ 25 g (≈ 48 g) • T4YI: ≈ 123 g (≈ 181 g) • T4WI: ≈ 140 g (≈ 231 g) • T3SI: ≈ 80 g (≈ 120 g) • T3HI: ≈ 137 g (≈ 203 g) • T4MI: ≈ 137 g (≈ 202 g) • T4LI: ≈ 185 g (≈ 274 g)

01) In case of T3NI, T3SI Series and the decimal point display models
 At room temperature (23 °C ±5 °C): (PV ±0.5% or ±2 °C higher one) ±1 digit
 Out of room temperature range: (PV ±0.5% or ±3 °C higher one) ±1 digit

Bar Graphic Temperature Indicators

KN-1000B Series



Features

- High accuracy with 16 bit ADC ($\pm 0.2\%$ F.S.)
- Multi-input
 - Thermometer 12 types
 - RTD 5 types
 - Analog: current 2 types / voltage 4 types
- 101 LED bar graph (green)
- Various output options
 - Alarm output: 2 points / 4 points
 - 4 - 20 mA transmission output (isolated), RS485 Communication output
- Various functions
 - Bar graph alarm display
 - High / Low peak input monitoring
 - Alarm output (upper / lower, sensor break)
 - Transmission output / display scale
 - Digital input (DI), etc.
- Built-in power supply for sensor / transmitter (24 VDC \equiv)
- Small size (rear length: 70 mm)

Specifications

Series		KN-1000B Series	
		AC voltage	DC voltage
Power supply		100 - 240 VAC \sim 50/60 Hz	24 VDC \equiv
Allowable voltage range		90 to 110% of rated voltage	
Power consumption		≤ 6 VA	≤ 4 W
Sampling period		• Thermocouple, RTD: 250 ms • Analog: 100 ms	
Input specification		Refer to Autonics website	
Digital input	Contact	• ON: ≤ 2 k Ω • OFF: ≥ 90 k Ω	
	Non contact	• Residual voltage: ≤ 1.0 V • leakage current: ≤ 0.03 mA	
	Outflow current	≈ 0.2 mA	
Option output	Alarm	• 2 point relay: 250 VAC \sim 3 A 1c • 4 point relay: 250 VAC \sim 1 A 1a	
	PV transmission	ISOLATED DC 4-20 mA (Load resistance: ≤ 600 Ω)	
	RS485 comm.	Modbus RTU	
Display type		7 Segment (red), Graph bar (green)	
Alarm output Hysteresis		1 to 999 digit	
Relay life cycle	Mechanical	• 2 point: $\geq 10,000,000$ operations • 4 point: $\geq 20,000,000$ operations	
	Electrical	• 2 point: $\geq 100,000$ operations (load resistance: 250 VAC \sim 3 A) • 4 point: $\geq 500,000$ operations (load resistance: 250 VAC \sim 1 A)	
Dielectric strength		Between input terminal and power terminal: 2,000 VAC \sim 50/60 Hz for 1 min	
Vibration		0.75 mm amplitude at frequency of 5 to 55 Hz (for 1 min) in each X, Y, Z direction for 2 hours	
Insulation resistance		≥ 100 M Ω (500 VDC \equiv megger)	
Noise immunity		± 2 kV square shaped noise (pulse width 1 μ s) by noise simulator	
Memory retention		≈ 10 years (non-volatile semiconductor memory type)	
Ambient temperature		-10 to 50 $^{\circ}$ C, storage: -20 to 60 $^{\circ}$ C (no freezing or condensation)	
Ambient humidity		35 to 85%RH, storage: 35 to 85%RH (no freezing or condensation)	
Approval		CE ENEC	
Unit weight (packaged)		≈ 182 g (≈ 304 g)	
Comm. protocol		Modbus 1.1 RTU	

1-Channel Digital Temperature Indicators

KN-2000W Series



Features

- High accuracy with 16 bit ADC ($\pm 0.2\%$ F.S.)
- Max. display range: -19999 to 19999
- Multi-input
 - Thermometer 12 types
 - RTD 5 types
 - Analog: Current 2 types / voltage 6 types
- Auto display color change function
 - Selectable indicator colors when error occurs or alarm operates
- Various output options
 - Alarm output: 2 points / 4 points
 - 4 - 20 mA transmission output (isolated), RS485 Communication output
- Various functions
 - High / Low peak input monitoring
 - Alarm output (upper / lower, sensor break)
 - Transmission output/display scale
 - Digital input (DI), etc.
- Built-in power supply for sensor / transmitter (24 VDC)

Specifications

Series		KN-2000W Series	
		AC voltage	DC voltage
Power supply		100 - 240 VAC~ 50/60 Hz	24 VDC==
Power consumption		≤ 8 VA	≤ 3 W
Sampling period		• Thermocouple, RTD: 250 ms • Analog: 100 ms	
Input specification		Refer to Autonics website	
Digital input	Contact	• ON: ≤ 2 k Ω • OFF: ≥ 90 k Ω	
	Non contact	• Residual voltage: ≤ 1.0 V • Leakage current: ≤ 0.03 mA	
	Outflow current	≈ 0.2 mA	
Option output	Alarm	• 2 point relay: 250 VAC~ 3 A 1c • 4 point relay: 250 VAC~ 1 A 1a	
	PV Transmission	ISOLATED DC 4-20 mA (Load resistance: ≤ 600 Ω)	
	RS485 comm.	Modbus RTU	
Display type		7 Segment (Red, Green, Yellow), LED type	
Alarm output Hysteresis		1 to 999 digit	
Relay life cycle	Mechanical	• 2 point: $\geq 10,000,000$ operations • 4 point: $\geq 20,000,000$ operations	
	Electrical	• 2 point: $\geq 100,000$ operations (Load resistance: 250 VAC~ 3 A) • 4 point: $\geq 500,000$ operations (Load resistance: 250 VAC~ 1 A)	
Dielectric strength		Between input terminal and power terminal: 2,000 VAC~ 50/60 Hz for 1 min	
Vibration		0.75 mm amplitude at frequency of 5 to 55 Hz (for 1 min) in each X, Y, Z direction for 2 hours	
Insulation resistance		≥ 100 M Ω (500 VDC== megger)	
Noise immunity		± 2 kV square shaped noise (pulse width 1 μ s) by noise simulator	
Memory retention		≈ 10 years (non-volatile semiconductor memory type)	
Ambient temperature		-10 to 50 $^{\circ}$ C, storage: -20 to 60 $^{\circ}$ C (no freezing or condensation)	
Ambient humidity		35 to 85%RH, storage: 35 to 85%RH (no freezing or condensation)	
Approval		CE ENEC	
Unit weight (packaged)		≈ 200 g (≈ 332 g)	
Comm. protocol		Modbus 1.1 RTU	

Modular 2/4-Channel PID Temperature Controllers with Screw Connector

TMH Series



Features

- Common
 - Easy maintenance with detachable body and base terminal
 - Power supply and communication with expansion connectors (up to 32 units)
- **[TMH2/4 Series (Control Module)]**
 - Multi-channel (2-channel / 4-channel) input and output control: Expandable up to 32 units (64-channels / 128-channels)
 - 50 ms high-speed sampling rate and $\pm 0.3\%$ measurement accuracy
 - Simultaneous heating and cooling control function and auto / manual control mode
- **[TMHA (Analog Input / Output Option Module)]**
 - 4 channels, various input types / temperature ranges / transmission outputs
 - 50 ms high-speed sampling rate and $\pm 0.3\%$ measurement accuracy
- **[TMHE (Digital Input / Alarm Output Option Module)]**
 - 8 digital inputs / 8 alarm outputs
- **[TMHCT (CT Input Option Module)]**
 - 8 CT inputs
- **[TMHC (Communication Modules)]**
 - Allows connection of control modules and option modules to master devices
 - Connect up to 32 control / option modules per communication model

Specifications

[Control module]

Model	TMH2	TMH4
No. of channels	2 channels	4 channels
Sampling period	50 ms (2 channels or 4 channels synchronous sampling)	
Input specification	Thermocouple, RTD, Analog (refer to 'Input Specification')	
CT input	<ul style="list-style-type: none"> • 0.0 - 50.0A (primary current measurement range) • CT ratio: 1/1,000, • Measurement accuracy: $\pm 5\%$ F.S. ± 1 digit 	
Digital input	<ul style="list-style-type: none"> • Connect input ON: ≤ 1 kΩ, OFF: ≥ 100 kΩ • Solid state input Residual voltage: ≤ 0.9 V, Leakage current: ≤ 0.5 mA • Outflow current: ≈ 0.3 mA per input 	-
Control type	Heating, cooling, heating & cooling: ON/OFF, P, PI, PD, PID control	
Control output	<ul style="list-style-type: none"> • Relay: 250 VAC\sim 3 A 1a mechanical life cycle: $\geq 10,000,000$ operations, electrical life cycle: $\geq 100,000$ operations • SSR: 12 VDC\pm ± 3 V, ≤ 20 mA • Current⁰¹⁾: DC 4 - 20 mA or DC 0 - 20 mA (Load: ≤ 500 Ω) 	
Alarm output	250 VAC \sim 3 A 1a	-
	Mechanical life cycle: $\geq 10,000,000$ operations	
	Electrical life cycle: $\geq 100,000$ operations	
Communication	Modbus RTU	
Hysteresis	<ul style="list-style-type: none"> • Thermocouple / RTD: 1 to 100 (0.1 to 100) $^{\circ}\text{C}/^{\circ}\text{F}$ • Analog: 1 to 100 digit 	
Proportional band (P)	<ul style="list-style-type: none"> • Thermocouple / RTD: 1 to 999 (0.1 to 999.9) $^{\circ}\text{C}/^{\circ}\text{F}$ • Analog: 0.1 to 999.9 digit 	
Integral time (I)	0 to 9,999 sec	
Derivative time (D)	0 to 9,999 sec	
Control period (T)	<ul style="list-style-type: none"> • Relay output, SSR drive output: 0.1 to 120.0 sec • Selectable current or SSR drive output: 1.0 to 120.0 sec 	
Manual reset	0 to 100 (0.0 to 100.0) %	
Insulation type	Double insulation or reinforced insulation (mark: \square), dielectric strength between the measuring input part and the power part: 1 kV)	
Unit weight (packaged)	<ul style="list-style-type: none"> • Basic module: ≈ 178 g (≈ 251 g) • Expansion module: ≈ 173 g (≈ 246 g) 	

01) When the control output is set to the current output, the heater current value monitoring function through the CT input terminals is not available.

Next Page ►



[Option module]

Model	TMHA-42AE	
No. of channels	4 channels	
Sampling period	50 ms (4 channels synchronous sampling)	
Input specification	Thermocouple, RTD, analog (refer to 'Input Specification')	
Transmission output	DC 4 - 20 mA or DC 0 - 20 mA (Load: ≤ 500 Ω)	
Communication	Modbus RTU	
Insulation type	Double insulation or reinforced insulation (mark: □, dielectric strength between the measuring input part and the power part: 1 kV)	
Unit weight (packaged)	≈ 161 g (≈ 234 g)	
Model	TMHE-82RE	TMHCT-82NE
No. of channels	8 points	8 points
Input specification	<ul style="list-style-type: none"> - Digital input • Connect input ON: ≤ 1 kΩ, OFF: ≥ 100 kΩ • Solid state input Residual voltage: ≤ 0.9 V, Leakage current: ≤ 0.5 mA • Outflow current: ≈ 0.3 mA per input 	<ul style="list-style-type: none"> - CT input • 0.0-50.0 A (primary current measurement range) • CT ratio: 1/1,000 • Measurement accuracy: ±5% F.S. ±1 digit
Alarm output	250 VAC~ 3 A 1a, <ul style="list-style-type: none"> • Mechanical life cycle: ≤ 10,000,000 operations • Electrical life cycle: ≤ 100,000 operations 	-
Communication	Modbus RTU	
Insulation type	Double insulation or reinforced insulation (mark: □, dielectric strength between the measuring input part and the power part: 1 kV)	-
Unit weight (packaged)	≈ 166 g (≈ 239 g)	≈ 148 g (≈ 221 g)

[Communication module]

Model	TMHC-22LE		TMHC-22EE
Communication	COM1	• Connection type: RS422 / RS485	• Connection type: Ethernet (10/100BaseT)
	COM2	• Protocol: Modbus RTU, PLC Ladderless communication	• Protocol: Modbus TCP
	PC loader	TTL (Protocol: Modbus RTU)	
Insulation type	Double insulation or reinforced insulation (mark: □, dielectric strength between the measuring input part and the power part: 1 kV)		
Unit weight (packaged)	≈ 147 g (≈ 219 g)		≈ 129 g (≈ 200 g)

[Common]

Power supply ⁰¹⁾	24 VDC=
Allowable voltage range	90 to 110% of rated voltage
Power Consumption	≤ 5 W (for max. load)
Display type	None- parameter setting and monitoring is available at external devices
Memory retention	≈ 10 years (non-volatile semiconductor memory type)
Insulation resistance	100 MΩ (500 VDC= megger)
Dielectric strength	Between the charging part and the case: 1,000 VAC~ 50/60 Hz for 1 min
Vibration	0.75mm amplitude at frequency of 5 to 55Hz (for 1 min) in each X, Y, Z direction for 2 hours
Noise immunity	Square shaped noise by noise simulator (pulse width 1 μs) ±0.5 kV
Ambient temperature	-10 to 50 °C, storage: -20 to 60 °C (no freezing or condensation)
Ambient humidity	35 to 85%RH, Storage: 35 to 85%RH (no freezing or condensation)
Accessory	Expansion connector: 1, module lock connector: 2
Protection structure	IP20 (IEC standard)
Approval	CE   

01) The control extension/option/communication module uses the power voltage from the control basic module.

Modular 2/4-Channel PID Temperature Controllers with Screwless Connector

TM Series



Features

- Multi-channel (4-channel: TM4 / 2-channel: TM2) input and output control
- High-speed sampling cycle (4-channel: 100ms / 2-channel : 50ms)
- Module connection and expansion with expansion connectors
 - Communication between modules
 - No additional power supply wiring
 - Expandable up to 31 units (124-channels / 62-channels)
- Simultaneous heating and cooling control function
- Isolated input channels (dielectric strength: 1000 VAC)
- Switch between current output and SSR drive output (TM2- 2C)
- Parameter configuration via PC (USB and RS485 communication)
 - DAQMaster software included (comprehensive device management software)
 - Communication converter sold separately: SCM-US (USB to serial converter), SCM-381 (RS-232C to RS485 converter), SCM-US481 (USB to RS485 converter)
- Easy wiring and maintenance with various connectors: sensor input connector, control output connector, power / communication connector
- Heater disconnect alarm function (CT input)
 - Current transformer (CT) sold separately: CSTC-E80LN, CSTC-E200LN
- Various input types and temperature ranges

Specifications

Series	TM2	TM4	
No. of channels	2 channels	4 channels	
Power supply	24 VDC \pm 10%		
Allowable voltage range	90 to 110% of rated voltage		
Power consumption	\leq 5 W (for Max. load)		
Sampling period	50 ms (2 channels synchronous sampling)	100 ms (4 channels synchronous sampling)	
Input specification	Refer to Autonics website		
Option input	CT input	<ul style="list-style-type: none"> • 0.0-50.0 A (primary current measurement range) • CT ratio: 1/1,000 • Measurement accuracy: \pm5% F.S. \pm1 digit 	-
	Digital input	<ul style="list-style-type: none"> • Contact ON: \leq 1 kΩ, OFF: \geq 100 kΩ • Non contact residual voltage: \leq 1.5 VDC\leq leakage current: \leq 0.1 mA • Outflow current: \approx 0.5 mA per input 	-
Control output	Relay	250 VAC \sim 3 A 1a, 30 VDC \leq 3 A 1a	
	SSR	12 VDC \leq \pm 3 V, \leq 30 mA	22 VDC \leq \pm 3 V, \leq 30 mA
	Current	DC 4 - 20 mA or DC 0 - 20 mA (Load resistance: \leq 500 Ω)	
Alarm output	250 VAC \sim 3 A 1a		-
RS485 Comm.	Modbus RTU		
Display type	None- parameter setting and monitoring is available at external devices		
Control type	Heating, Cooling	ON/OFF, P, PI, PD, PID Control	
	Heating & Cooling		
Hysteresis	1 to 100 (0.1 to 100) $^{\circ}$ C/ $^{\circ}$ F		
Proportional band (P)	0.1 to 999.9 $^{\circ}$ C/ $^{\circ}$ F		
Integral time (I)	0 to 9,999 sec		
Derivative time (D)	0 to 9,999 sec		
Control cycle (T)	0.1 to 120.0 sec		
Manual reset	0.0 to 100.0 %		
Relay life cycle	Mechanical	\geq 10,000,000 operations	
	Electrical	\geq 100,000 operations (250 VAC \sim 3 A load resistance)	
Dielectric strength	Between input terminal and power terminal: 2,000 VAC \sim 50/60 Hz for 1 min		
Vibration	0.75 mm amplitude at frequency of 5 to 55 Hz (for 1 min) in each X, Y, Z direction for 2 hours		
Insulation resistance	100 M Ω (500 VDC \leq megger)		
Noise immunity	\pm 0.5 kV square shaped noise (pulse width 1 μ s) by noise simulator		
Ambient temperature	-10 to 50 $^{\circ}$ C, storage: -20 to 60 $^{\circ}$ C (no freezing or condensation)		
Ambient humidity	35 to 85%RH, storage: 35 to 85%RH (no freezing or condensation)		
Channel insulation	Dielectric strength 1,000 VAC \sim		
Insulation type	Double insulation or reinforced insulation (mark: \square , dielectric strength between the measuring input part and the power part: 1 kV)		
Approval	CE, RoHS, ENEC, EAC		
Unit weight (packaged)	• Basic module: \approx 152 g (\approx 217 g)		• Basic module: \approx 174 g (\approx 239 g)
	• Expansion module: \approx 143 g (\approx 208 g)		• Expansion module: \approx 166 g (\approx 231 g)
Comm. protocol	Modbus RTU		

Independent Single Display PID Temperature Controllers

TR1D Series



Features

- Compact, space-saving design with 22.5 mm width size
- 50 ms high-speed sampling and $\pm 0.3\%$ display accuracy
- Simultaneous heating / cooling and automatic / manual control function
- Switch between current output and SSR drive output
- Easy mount on DIN rails
- RS485 communication output model available
 - Protocol: Modbus RTU or ASCII
 - Communication speed: up to 115,200 bps
- Parameter setting via PC (USB or RS485 communication)
 - Comprehensive device management software (DAQMaster) provided
- Heater disconnect alarm function (CT input)
 - Current transformer (CT) sold separately: CSTC-E80LN, CSTC-E200LN, CSTS-E80PP
 - Screen protection function

*1 Korea Patent Registration 10-2019-0158569,

Korea Design Registration 30-1065663,

China Design Registration 202030164351.2

Specifications

Series		TR1D Series
Power supply		100 - 240 VAC \sim 50/60 Hz
Allowable voltage range		90 to 110% of rated voltage
Power consumption		≤ 8 VA
Sampling period		50, 100, 250 ms
Input specification		Refer to Autonics website
Option input	CT input	<ul style="list-style-type: none"> • 0.0-50.0 A (primary current measurement range) • CT ratio: 1/1,000, • Measurement accuracy: $\pm 5\%$ F.S. ± 1digit
Control output	Relay	250 VAC \sim 3 A 1a
	SSR	12 VDC \pm ± 3 V, ≤ 20 mA
	Current	DC 4-20 mA or DC 0-20 mA (parameter), Load: $\leq 500 \Omega$
Option output	Alarm	AL1, AL2: 250 VAC \sim 3 A 1a
	Transmission	DC4-20 mA (Load resistance: $\leq 500 \Omega$, Output accuracy: $\pm 0.3\%$ F.S.)
RS485 comm.		Modbus RTU / ASCII
Display type		7 segment (red), 4-digit
Control type		ON/OFF, P, PI, PD, PID Control
Hysteresis		Control output: 1 to 100 $^{\circ}$ C/ $^{\circ}$ F (0.1 to 100.0 $^{\circ}$ C/ $^{\circ}$ F) Alarm output: 1 to 100 $^{\circ}$ C/ $^{\circ}$ F (0.1 to 50.0 $^{\circ}$ C/ $^{\circ}$ F)
Proportional band (P)		0.1 to 999.9 $^{\circ}$ C
Integral time (I)		0 to 9,999 sec
Derivative time (D)		0 to 9,999 sec
Control cycle (T)		Relay output: 0.5 to 120.0 sec, SSR drive output: 0.5 to 120.0 sec
Manual reset		0.0 to 100.0%
Dielectric strength		Between the power part and the case: 3,000 VAC \sim 50/60 Hz for 1 min
Vibration		0.75 mm amplitude at frequency of 5 to 55Hz (for 1 min) in each X, Y, Z direction for 2 hours
Relay life cycle	Mechanical	OUT1/2, AL1/2: $\geq 5,000,000$ operations
	Electrical	OUT1/2, AL1/2: $\geq 100,000$ operations (resistance load: 250 VAC \sim 5 A)
Insulation resistance		≥ 100 M Ω (500 VDC \pm megger)
Insulation type		Double insulation or reinforced insulation (dielectric strength between the power part and the case: 3 kV)
Noise immunity		Square shaped noise (pulse width: 1 μ s) by noise simulator ± 2 kV R-phase, S-phase
Memory retention		≈ 10 years (non-volatile semiconductor memory type)
Ambient temperature		-10 to 50 $^{\circ}$ C, storage: -20 to 60 $^{\circ}$ C (no freezing or condensation)
Ambient humidity		35 to 85%RH, storage: 35 to 85%RH (no freezing or condensation)
Approval		CE ENEC
Unit weight (packaged)		≈ 123.5 g (≈ 194.5 g)
Comm. protocol		Modbus RTU / ASCII



E2. Digital Panel Meters

Multi panel meters are used to measure and monitor various industrial processes including voltage, current, frequency, and pressure.

E2-1	Panel Meters	MX4W Series	LCD Multi Panel Meters
		MT4N Series	4-Digit Multi Panel Meters
		MT4W Series	4-Digit Multi Panel Meters
		MT4Y Series	4-Digit Multi Panel Meters
		M4NN Series	4-Digit Multi Panel Meters
		M4N Series	Panel Meters (Indicator)
		M4M Series	Indicator / Thumbwheel Switch Panel Meters
		M4W Series	Indicator / Thumbwheel Switch Panel Meters
		M4Y Series	Panel Meters (Indicator)
		M5W Series	Panel Meters (Indicator)
		M4NS / M4YS Series	Loop-Power Panel Meters (Indicator)
		M4V Series	Digital Panel Meters for Mosaic Panels (Indicator)
		E2-2	Pulse Meters
MP5M Series	Thumbwheel Switch Multi Pulse Meters		
MP5S / MP5Y / MP5W Series	Multi Pulse Meters		

LCD Multi Panel Meters



MX4W Series



Features

- LCD display with easy-to-read white PV characters
- Isolated input and power modules allow powering of multiple units using a single power supply
- Compact, space-saving design (rear-length: 20 mm): reduced rear-length size by 80 % compared to same DIN size panel meters (MT4W)
- Various input options (by model)
 - Input options: DC / AC voltage, DC / AC current
- Maximum allowed input: 500 VDC \equiv , 500 VAC \sim , DC 5 A, AC 5 A
- Display range: -9999 to 9999
- High / low-limit display scale function
- AC frequency measurement (range: 0.100 to 1200 Hz)
- Preset output: OUT1, OUT2 (NPN / PNP open collector output)
- Power factor display / output function: displays analog outputs (1 - 5 V, 4 - 20 mA) from power factor converters as -0.50 to 1.00 to 0.50
- Various functions: peak display value monitoring, display cycle delay, zero-point adjustment, peak display value correction, etc.
- Power supply: 24 - 240 VAC \sim 50 / 60 Hz, 24 - 240 VDC \equiv universal

Specifications

Model	MX4W-V-F□	MX4W-A-F□
Input type	DC / AC voltage	DC / AC current
Max. allowable input	Dependent on the input type	
+DC input	≈ -10 to 110 % F.S. for each measured input range	
-DC input	≈ -110 to 110 % F.S. for each measured input range	
AC input	≈ 110 % F.S. for each measured input range	
Display method	12-segment LCD ⁰¹⁾ - measurement value display part: white, character height: 19 mm - other display parts: red, green, yellow (indicator: white)	
Display accuracy	Dependent on the ambient temperature	
23 ± 5 °C (DC input)	± 0.1 % F.S. rdg ± 2-digit	± 0.1 % F.S. rdg ± 2-digit ⁰²⁾
23 ± 5 °C (AC input)	± 0.3 % F.S. rdg ± 3-digit	± 0.3 % F.S. rdg ± 3-digit
0 to 50 °C	± 0.5 % F.S. rdg ± 3-digit	± 0.5 % F.S. rdg ± 3-digit ⁰³⁾
Display cycle	0.2 to 5.0 sec (select per 0.1 sec)	
Display scale	-9999 to 9999 (4-digit)	
A / D conversion method	ΣΔ (Sigma Delta) analog-to-digital converter	
Sampling cycle (DC input)	50 ms	
Sampling cycle (AC input)	16.6 ms	
Resolution	1 / 20,000	
Preset output	NPN / PNP open collector output model	
Load voltage	≤ 30 VDC \equiv	
Load current	≤ 100 mA	
Residual voltage	NPN open collector output: ≤ 1 VDC \equiv / PNP open collector output: ≤ 2 VDC \equiv	
Unit weight (packaged)	≈ 77 g (≈ 100 g)	
Approval	CE 	
Power supply	24 - 240 VDC \equiv ± 10 %, 24 - 240 VAC \sim ± 10 % 50 / 60 Hz	
Power consumption	DC: ≤ 3 W, AC: ≤ 5 VA	
Insulation resistance	≥ 100 MΩ (500 VDC \equiv megger)	
Dielectric strength	Between all terminals and case: 3,000 VAC \sim 50 / 60 Hz for 1 min	
Noise immunity	± 2 kV square wave noise (pulse width: 1 μs) by the noise simulator	
Vibration	0.75 mm double amplitude at frequency of 10 to 55 Hz (for 1 minute) in each X, Y, Z direction for 2 hours	
Vibration (malfunction)	0.5 mm double amplitude at frequency of 10 to 55 Hz (for 1 minute) in each X, Y, Z direction for 10 min	
Shock	300 m/s ² (≈ 30 G) in each X, Y, Z direction for 3 times	
Shock (malfunction)	100 m/s ² (≈ 10 G) in each X, Y, Z direction for 3 times	
Ambient temperature	-10 to 50 °C, storage: -20 to 60 °C (no freezing or condensation)	
Ambient humidity	35 to 85 %RH, storage: 35 to 85 %RH (no freezing or condensation)	
Insulation type	Symbol:  double or reinforced insulation (dielectric strength between the measurement input part and the power part: 1 kV)	

01) When using the unit at low temperature (below 0 °C), display cycle is slow due to characteristics of LCD. Control output operates normally.

02) 5 A terminal: ± 0.3 % F.S. rdg ± 3-digit

03) 5 A terminal: ± 1 % F.S. rdg ± 3-digit



4-Digit Multi Panel Meters

MT4N Series



Features

- Various input / output options (by model)
 - Input options: DC voltage, DC current, AC voltage, AC current
 - Output options: RS485 communication output, transmission output (DC 4 - 20 mA), NPN / PNP open collector output, relay contact output (default option: indicator / no output)
- Maximum allowed input: 50 VDC \approx , DC 500 mA, 250 VAC \sim , AC 5A
- Display range: -1999 to 9999
- High / low-limit display scale function
- AC frequency measurement (range: 0.1 to 9999 Hz)
- Various functions: peak display value monitoring, display cycle delay, zero-point adjustment, peak display value correction, PV transmission output (DC 4 - 20 mA) scale, etc.
- Power supply: 12 - 24 VDC \approx / VAC \sim , 100 - 240 VAC \sim

Specifications

Model	MT4N-DV-□□	MT4N-DA-□□	MT4N-AV-□□	MT4N-AA-□□
Input type	DC voltage	DC current	AC voltage ⁰¹⁾	AC current ⁰¹⁾
Max. allowable input	110 % F.S. for each measured input range			
Display method	7-segment (red) LCD (character height: 9 mm)			
Display accuracy	Dependent on the ambient temperature			
	23 ± 5 °C	± 0.1 % F.S. rdg ± 2 digit ⁰²⁾		± 0.3 % F.S. rdg ± 3 digit
	-10 to 50 °C	± 0.5 % F.S. rdg ± 3 digit		
Max. display range	-1999 to 9999 (4 digit)			
A / D conversion method	Practical oversampling using successive approximation ADC			
Sampling cycle	50 ms	16.6 ms		
Unit weight (packaged)	≈ 64 g (≈ 127 g)			
Approval	CE ENEC			
	01) Available frequency display 02) 5 A terminal: ± 0.3 % F.S. rdg ± 3 digit			
Pre-set output	None (indicator) / Relay / NPN open collector / PNP open collector output model			
Relay	Contact capacity: 125 VAC \sim 0.3 A, 30 VDC \approx 1 A Contact composition: N.O (1a)			
NPN / PNP open collector	Output capacity: ≤ 12 - 24 VDC \approx ± 2 VDC \approx , 50 mA resistive load			
Sub output	None (indicator) / Transmission (DC 4 - 20 mA) / RS485 communication output model			
Transmission (DC 4 - 20 mA)	Resolution: 1/12,000 (load resistance: ≤ 600 Ω) Response time: ≤ 450 ms			
RS485 communication	Protocol: Modbus RTU			
Power supply	12 - 24 VDC \approx ± 10 %, 12 - 24 VAC \sim ± 10 % 50 / 60 Hz / 100 - 240 VAC \sim ± 10 % 50 / 60 Hz model			
Power consumption (DC / AC voltage)	3 W / 5 VA ⁰¹⁾			
Power consumption (AC voltage)	5 VA			
Insulation resistance	≥ 20 MΩ (500 VDC \approx megger)			
Dielectric strength (DC / AC voltage)	Between external terminal and case: 1,000 VAC \sim 50 / 60 Hz for 1 min			
Dielectric strength (AC voltage)	Between external terminal and case: 2,000 VAC \sim 50 / 60 Hz for 1 min			
Noise immunity	± 2 kV square wave noise (pulse width: 1 μs) by the noise simulator			
Vibration	0.75 mm double amplitude at frequency of 10 to 55 Hz (for 1 min) in each X, Y, Z direction for 2 hours			
Vibration (malfunction)	0.5 mm double amplitude at frequency of 10 to 55 Hz (for 1 min) in each X, Y, Z direction for 10 min			
Shock	300 m/s ² (≈ 30 G) in each X, Y, Z direction for 3 times			
Shock (malfunction)	100 m/s ² (≈ 10 G) in each X, Y, Z direction for 3 times			
Ambient temp.	-10 to 50 °C, storage: -20 to 60 °C (no freezing or condensation)			
Ambient humi.	35 to 85 %RH, storage: 35 to 85 %RH (no freezing or condensation)			
Insulation type	Symbol:  double or reinforced insulation (dielectric strength between the measurement input part and the power part: 1 kV)			
Comm. protocol	Modbus RTU			

01) Except MT4N-□□-E5: 5 W / 8 VA

4-Digit Multi Panel Meters

MT4W Series



Features

- Various input / output options (by model)
 - Input options: DC voltage, DC current, AC voltage, AC current
 - Output options: RS485 communication output, low speed serial output, BCD dynamic output, transmission output (DC 4 - 20 mA), NPN / PNP open collector output, relay contact output (default option: indicator / no output)
- Maximum allowed input:
500 VDC \equiv , DC 5 A, 500 VAC \sim , AC 5 A
- Display range: -1999 to 9999
- High / low-limit display scale function
- AC frequency measurement
(range: 0.1 to 9999 Hz)
- Various functions: peak display value monitoring, display cycle delay, zero-point adjustment, peak display value correction, PV transmission output (DC 4 - 20 mA) scale, etc.
- Power supply:
12 - 24 VDC \equiv , 100 - 240 VAC \sim
- DIN W 72 × H 36 mm

Specifications

Model	MT4W-DV-□□	MT4W-DA-□□	MT4W-AV-□□	MT4W-AA-□□
Input type	DC voltage	DC current	AC voltage ⁰¹⁾	AC current ⁰¹⁾
Max. allowable input	110 % F.S. for each measured input range			
Display method	7-segment (red) LED (character height: 14.2 mm)			
Display accuracy	Dependent on the ambient temperature			
23 ± 5 °C	± 0.1 % F.S. rdg ± 2 digit	± 0.1 % F.S. rdg ± 2 digit ⁰²⁾	± 0.3 % F.S. rdg ± 3 digit	± 0.3 % F.S. rdg ± 3 digit
-10 to 50 °C	± 0.5 % F.S. rdg ± 3 digit			
Max. display range	-1999 to 9999 (4 digit)			
A / D conversion method	ΣΔ (Sigma Delta) ADC			
Sampling cycle	50 ms		16.6 ms	
Unit weight (packaged)	≈ 211 g (≈ 326 g)			
Approval	CE  ⁰³⁾ ENEC			
	01) Available frequency display, Display accuracy (23 ± 5 °C): ± 0.1 % F.S. rdg ± 2 digit 02) 5 A terminal: ± 0.3 % F.S. rdg ± 3 digit 03) Except power supply 12 - 24 VDC \equiv model			
Preset output	None (indicator) / Relay / NPN open collector / PNP open collector output model			
Relay	Contact capacity: 250 VAC \sim 3 A, 30 VDC \equiv 3 A Contact composition: N.O (1a)			
NPN / PNP open collector	Output capacity: ≤ 12 - 24 VDC \equiv ± 2 VDC \equiv , 50 mA resistive load			
Sub output	None (indicator) / BCD Dynamic / Transmission (DC 4 - 20 mA) / Low speed serial / RS485 Communication output model			
BCD Dynamic / Low speed serial	NPN open collector output Output capacity: ≤ 12 - 24 VDC \equiv , 50 mA resistive load			
Transmission (DC 4 - 20 mA)	Resolution: 1/12,000 (load resistance: ≤ 600 Ω) Response time: ≤ 450 ms			
RS485 communication	Protocol: Modbus RTU			
Model	MT4W-□□-1□	MT4W-□□-4□		
Power supply	12 - 24 VDC \equiv ± 10 %	100 - 240 VAC \sim ± 10 % 50 / 60 Hz		
Power consumption	5 W	5 VA		
Insulation resistance	Between external terminal and case: ≥ 100 MΩ (500 VDC \equiv megger)			
Dielectric strength	Between external terminal and case: 2,000 VAC \sim 50 / 60 Hz for 1 min			
Noise immunity	± 2 kV square wave noise (pulse width: 1 μs) by the noise simulator			
Vibration	0.75 mm double amplitude at frequency of 10 to 55 Hz (for 1 min) in each X, Y, Z direction for 2 hours			
Vibration (malfunction)	0.5 mm double amplitude at frequency of 10 to 55 Hz (for 1 min) in each X, Y, Z direction for 10 min			
Shock	300 m/s ² (≈ 30 G) in each X, Y, Z direction for 3 times			
Shock (malfunction)	100 m/s ² (≈ 10 G) in each X, Y, Z direction for 3 times			
Relay life cycle	Mechanical: ≥ 20,000,000 operations Electrical: ≥ 100,000 operations (250 VAC \sim 3A resistive load)			
Ambient temp.	-10 to 50 °C, storage: -20 to 60 °C (freezing or condensation)			
Ambient humi.	35 to 85 %RH, storage: 35 to 85 %RH (freezing or condensation)			
Insulation type	Symbol:  double or reinforced insulation (dielectric strength between the measurement input part and the power part: 1 kV)			
Comm. protocol	Modbus RTU			

4-Digit Multi Panel Meters

MT4Y Series



Features

- Various input / output options (by model)
 - Input options: DC voltage, DC current, AC voltage, AC current
 - Output options: RS485 communication output, low speed serial output, BCD dynamic output, transmission output (DC 4 - 20 mA), NPN / PNP open collector output, relay contact output (default option: indicator / no output)
- Maximum allowed input: 500 VDC \equiv , DC 5 A, 500 VAC \sim , AC 5 A
- Display range: -1999 to 9999
- High / low-limit display scale function
- AC frequency measurement (range: 0.1 to 9999 Hz)
- Various functions: peak display value monitoring, display cycle delay, zero-point adjustment, peak display value correction, PV transmission output (DC 4 - 20 mA) scale, etc.
- Power supply: 12 - 24 VDC \equiv , 100 - 240 VAC \sim
- DIN W 96 × H 48 mm

Specifications

Model	MT4Y-DV-4□	MT4Y-DA-4□	MT4Y-AV-4□	MT4Y-AA-4□
Input type	DC voltage	DC current	AC voltage ⁰¹⁾	AC current ⁰¹⁾
Max. allowable input	110 % F.S. for each measured input range			
Display method	7-segment (red) LED (character height: 14.2 mm)			
Display accuracy	Dependent on the ambient temperature			
23 ± 5 °C	± 0.1 % F.S. rdg ± 2 digit	± 0.1 % F.S. rdg ± 2 digit ⁰²⁾	± 0.3 % F.S. rdg ± 3 digit	± 0.3 % F.S. rdg ± 3 digit
-10 to 50 °C	± 0.5 % F.S. rdg ± 3 digit			
Max. display range	-1999 to 9999 (4 digit)			
A / D conversion method	$\Sigma\Delta$ (Sigma Delta) ADC			
Sampling cycle	50 ms		16.6 ms	
Unit weight (packaged)	≈ 134 g (≈ 213.5 g)			
Approval	CE			
<small>01) Available frequency display, Display accuracy (23 ± 5 °C): ± 0.1 % F.S. rdg ± 2 digit 02) 5 A terminal: ± 0.3 % F.S. rdg ± 3 digit</small>				
Preset output	None (indicator) / Relay / NPN open collector / PNP open collector output model			
Relay	Contact capacity: 250 VAC \sim 3 A, 30 VDC \equiv 3 A Contact composition: N.O (1a)			
NPN / PNP open collector	Output capacity: ≤ 12 - 24 VDC \equiv ± 2 VDC \equiv , 50 mA resistive load			
Sub output	None (indicator) / BCD Dynamic / Transmission (DC 4 - 20 mA) / Low speed serial / RS485 Communication output model			
BCD Dynamic / Low speed serial	NPN open collector output Output capacity: ≤ 12 - 24 VDC \equiv , 50 mA resistive load			
Transmission (DC 4 - 20 mA)	Resolution: 1/12,000 (load resistance: ≤ 600 Ω) Response time: ≤ 450 ms			
RS485 communication	Protocol: Modbus RTU			
Power supply	100 - 240 VAC \sim ± 10 % 50 / 60 Hz			
Power consumption	5 VA			
Insulation resistance	Between external terminal and case: ≥ 100 M Ω (500 VDC \equiv megger)			
Dielectric strength	Between external terminal and case: 2,000 VAC \sim 50 / 60 Hz for 1 min			
Noise immunity	± 2 kV square wave noise (pulse width: 1 μ s) by the noise simulator			
Vibration	0.75 mm double amplitude at frequency of 10 to 55 Hz (for 1 min) in each X, Y, Z direction for 2 hours			
Vibration (malfunction)	0.5 mm double amplitude at frequency of 10 to 55 Hz (for 1 min) in each X, Y, Z direction for 10 min			
Shock	300 m/s ² (≈ 30 G) in each X, Y, Z direction for 3 times			
Shock (malfunction)	100 m/s ² (≈ 10 G) in each X, Y, Z direction for 3 times			
Relay life cycle	Mechanical: ≥ 20,000,000 operations Electrical: ≥ 100,000 operations (250 VAC \sim 3A resistive load)			
Ambient temp.	-10 to 50 °C, storage: -20 to 60 °C (no freezing or condensation)			
Ambient humi.	35 to 85 %RH, storage: 35 to 85 %RH (no freezing or condensation)			
Insulation type	Symbol: double or reinforced insulation (dielectric strength between the measurement input part and the power part: 1 kV)			
Comm. protocol	Modbus RTU			

4-Digit Multi Panel Meters

M4NN Series



Features

- Various input / output options (by model)
 - Input options: DC voltage, DC current, AC voltage, AC current
 - Output options: NPN open collector / PNP open collector (default: indicator / no output)
- Isolated input and power modules allow powering of multiple units using a single power supply
- Display range: -1999 to 9999
- High / low-limit display scale function
- AC frequency measurement (range: 0.1 to 9999 Hz)
- Preset output mode: OUT1, GO, OUT2 (NPN / PNP open collector output)
- Power factor display function: displays analog input (1 - 5 V, 4 - 20 mA) from power factor converters as -0.50 to 1.00 to 0.50
- Various functions: peak display value monitoring, display cycle delay, zero-point adjustment, peak display value correction
- Power supply: 5 - 24 VDC \equiv (isolated type)

Specifications

Model	M4NN-DV-1□	M4NN-DA-1□	M4NN-AV-1□	M4NN-AA-1□
Input type	DC voltage	DC current	AC voltage ⁽⁰¹⁾	AC current ⁽⁰¹⁾
Max. allowable input	Dependent on the input type			
+DC input	≈ -10 to 110 % F.S. for each measured input range		-	
-DC input	≈ -110 to 110 % F.S. for each measured input range		-	
AC input	-		≈ 110 % F.S. for each measured input range	
Display method	7-segment (red) LED (character height: 11 mm)			
Display accuracy	Dependent on the ambient temperature			
23 ± 5 °C	± 0.1 % F.S. rdg ± 2-digit	± 0.1 % F.S. rdg ± 2-digit ⁽⁰²⁾	± 0.3 % F.S. rdg ± 3-digit	± 0.3 % F.S. rdg ± 3-digit
-10 to 50 °C	± 0.5 % F.S. rdg ± 3-digit	± 0.5 % F.S. rdg ± 3-digit ⁽⁰³⁾	± 0.5 % F.S. rdg ± 3-digit	± 0.5 % F.S. rdg ± 3-digit ⁽⁰³⁾
Display cycle	0.1 to 5.0 sec (select per 0.1 sec)			
Display scale	-1999 to 9999 (4-digit)			
A / D conversion method	Practical oversampling using successive approximation ADC			
Sampling cycle	50 ms		16.6 ms	
Resolution	1 / 12,000			
Preset output	NPN / PNP open collector output model			
Load voltage	≤ 30 VDC \equiv			
Load current	≤ 100 mA			
Residual voltage	NPN open collector output: ≤ 1 VDC \equiv / PNP open collector output: ≤ 2 VDC \equiv			
Unit weight (packaged)	≈ 46.8 g (≈ 83.7 g)		≈ 46.9 g (≈ 83.8 g)	
Approval	CE ENEC		CE ENEC	

01) Available frequency display

02) 5 A terminal: ± 0.3 % F.S. rdg ± 3-digit

03) 5 A terminal: ± 1 % F.S. rdg ± 3-digit

Power supply	5 - 24 VDC \equiv ± 10 % (low-limit: 5 VDC \equiv fixed)
Power consumption	≤ 3 W
Insulation resistance	≥ 100 MΩ (500 VDC \equiv megger)
Dielectric strength	Between all terminals and case: 2,000 VAC~ 50 / 60 Hz for 1 min
Noise immunity	± 2 kV square wave noise (pulse width: 1 μs) by the noise simulator
Vibration	0.75 mm double amplitude at frequency of 10 to 55 Hz (for 1 minute) in each X, Y, Z direction for 2 hours
Vibration (malfunction)	0.5 mm double amplitude at frequency of 10 to 55 Hz (for 1 minute) in each X, Y, Z direction for 10 min
Shock	300 m/s ² (≈ 30 G) in each X, Y, Z direction for 3 times
Shock (malfunction)	100 m/s ² (≈ 10 G) in each X, Y, Z direction for 3 times
Ambient temperature	-10 to 50 °C, storage: -20 to 60 °C (no freezing or condensation)
Ambient humidity	35 to 85 %RH, storage: 35 to 85 %RH (no freezing or condensation)
Insulation type	Symbol: □, double or reinforced insulation (dielectric strength between the measurement input part and the power part: 1 kV)
Connection	Plug type - socket type terminal

Panel Meters

(Indicator)

M4N Series



Features

- Input options (by model)
 - Input options: DC voltage, DC current
- Auto-zero adjustment and hold display value function
- Max display value: 1999
- 7-segment LED display
- Compact size: DIN W 48 × H 24 mm
- Power supply: 5 VDC \equiv , 12 - 24 VDC \equiv

Specifications

Model	M4N-DV-□□	M4N-DA-□□	M4N-DI-□X
Input type	DC voltage	DC current	DC 4 - 20 mA
Max. allowable input	≈ 150 % F.S. for each measured input range		
Display method	7-segment (red) LED (character height: 10 mm)		
Display accuracy	0.2 % F.S. rdg ± 1-digit		
Sampling time	2.5 times / sec		
Display scale	-1999 (4-digit)		
Operation method	Dual integral method		
Sampling cycle	300 ms		
Response speed	≈ 2 sec (0 to 1999)		
Unit weight	≈ 44 g		
Approval	EAC		
Power supply	5 VDC \equiv ± 10 % / 12 - 24 VDC \equiv ± 10 % model		
Power consumption	2 W		
Insulation resistance	≥ 100 MΩ (500 VDC \equiv megger)		
Dielectric strength	2,000 VAC~ 50 / 60 Hz for 1 min		
Noise immunity	±100 V square wave noise (pulse width: 1 μs) by the noise simulator		
Vibration	0.75 mm double amplitude at frequency of 10 to 55 Hz (for 1 minute) in each X, Y, Z direction for 1 hours		
Vibration (malfunction)	0.5 mm double amplitude at frequency of 10 to 55 Hz (for 1 minute) in each X, Y, Z direction for 10 min		
Shock	300 m/s ² (≈ 30 G) in each X, Y, Z direction for 3 times		
Shock (malfunction)	100 m/s ² (≈ 10 G) in each X, Y, Z direction for 3 times		
Ambient temperature	-10 to 50 °C, storage: -20 to 60 °C (no freezing or condensation)		
Ambient humidity	35 to 85 %RH, storage: 35 to 85 %RH (no freezing or condensation)		

Indicator / Thumbwheel Switch Panel Meters

M4M Series



Features

- Max. display value: 1999
- Auto-zero function and hold display value function
- Linear display based on input specification
- Display output values (0 - 10 VDC \approx) from power converters (options available for DC 4 - 20 mA, 1 - 5 VDC \approx)
- RMS or AVG value selection (AC voltage)
- 7-segment LED display
- DIN standard size models

Specifications

Input type	DC voltage	AC voltage	DC current	AC current	Power	Rotation, speed	Scaling
Max. allowable input	≤ 300 VDC \approx	≤ 400 VAC \sim	\leq DC 2 A	\leq AC 5 A	≤ 10 VDC \approx	≤ 10 VDC \approx ≤ 10 VAC \sim	DC 4 - 20 mA
	≈ 150 % F.S. for each measured input range ⁰¹⁾						
Display method	7-segment (red) LED (character height: 10 mm)						
Display accuracy	Dependent on the input type						
DC input	± 0.2 % F.S. rdg ± 1 -digit						
AC input	± 0.5 % F.S. rdg ± 1 -digit						
Display scale	1999						
Sampling time	2.5 times / sec						
Response speed	≈ 2 sec (0 to 1999)						
Sampling cycle	300 ms						
Operation method	Dual integral method						
Unit weight	Dependent on the output						
Indicator	≈ 262 g						
Single setting	≈ 290 g						
Dual setting	≈ 316 g						
Approval	EUL						

01) At 400 VAC \sim input: ≈ 120 % F.S. for each measured input range

Output	Indicator	Single setting	Dual setting
Power supply ⁰¹⁾	110 / 220 VAC \sim ± 10 % 50 / 60 Hz		
Power consumption	Dependent on the input type		
DC input	2 W	3 W	3 W
AC input	4 VA	5 VA	5 VA
Contact capacity	-	250 VAC \sim 3 A, 150 VDC \approx 3 A	250 VAC \sim 3 A, 150 VDC \approx 3 A
Contact composition	-	1c x 1	1c x 2
Insulation resistance	≥ 100 M Ω (500 VDC \approx megger)		
Dielectric strength	2,000 VAC \sim 50 / 60 Hz for 1 min		
Noise immunity	± 1 kV square wave noise (pulse width: 1 μ s) by the noise simulator		
Vibration	0.75 mm double amplitude at frequency of 10 to 55 Hz (for 1 minute) in each X, Y, Z direction for 1 hours		
Vibration (malfunction)	0.5 mm double amplitude at frequency of 10 to 55 Hz (for 1 minute) in each X, Y, Z direction for 10 min		
Shock	300 m/s ² (≈ 30 G) in each X, Y, Z direction for 3 times		
Shock (malfunction)	100 m/s ² (≈ 10 G) in each X, Y, Z direction for 3 times		
Relay life cycle	Mechanical: $\geq 10,000,000$ operations Electrical: $\geq 100,000$ operations (250 VAC \sim 3A resistive load)		
Ambient temperature	-10 to 50 $^{\circ}$ C, storage: -25 to 65 $^{\circ}$ C (no freezing or condensation)		
Ambient humidity	35 to 85 %RH, storage: 35 to 85 %RH (no freezing or condensation)		

01) Power supply 24 - 70 VDC \approx , 100 - 240 VAC \sim 50 / 60 Hz options are also available to order.

Indicator / Thumbwheel Switch Panel Meters

M4W Series



Features

- Max. display value: 1999
- Auto-zero function and hold display value function
- Linear display based on input specification
- Display output values (0 - 10 VDC \approx) from power converters (options available for DC 4 - 20 mA, 1 - 5 VDC \approx)
- RMS or AVG value selection (AC voltage)
- 7-segment LED display
- DIN standard size models

Specifications

Input type	DC voltage	AC voltage	DC current	AC current	Power	Rotation, speed	Scaling
Max. allowable input	≤ 300 VDC \approx	≤ 400 VAC \sim	\leq DC 2 A	\leq AC 5 A	≤ 10 VDC \approx	≤ 10 VDC \approx ≤ 10 VAC \sim	DC 4 - 20 mA
	≈ 150 % F.S. for each measured input range ⁰¹⁾						
Display method	7-segment (red) LED (character height: 14 mm)						
Display accuracy	Dependent on the input type						
DC input	± 0.2 % F.S. rdg ± 1 -digit					± 0.3 % F.S. rdg ± 1 -digit	
AC input	± 0.5 % F.S. rdg ± 1 -digit						
Display scale	1999						
Sampling time	2.5 times / sec						
Response speed	≈ 2 sec (0 to 1999)						
Sampling cycle	300 ms						
Operation method	Dual integral method						
Unit weight	Dependent on the output type						
Indicator	≈ 168 g						
Single setting	≈ 253 g						
Dual setting	≈ 278 g						
Approval	EUL						

01) At 400 VAC \sim input: ≈ 120 % F.S. for each measured input range

Output type	Indicator	Single setting	Dual setting
Power supply ⁰¹⁾	110 / 220 VAC \sim ± 10 % 50 / 60 Hz		
Power consumption	Dependent on the input type		
DC input	2 W	3 W	3 W
AC input	4 VA	5 VA	5 VA
Contact capacity	-	250 VAC \sim 3 A, 150 VDC \approx 3 A	250 VAC \sim 3 A, 150 VDC \approx 3 A
Contact composition	-	1c x 1	1c x 2
Insulation resistance	≥ 100 M Ω (500 VDC \approx megger)		
Dielectric strength	2,000 VAC \sim 50 / 60 Hz for 1 min		
Noise immunity	± 1 kV square wave noise (pulse width: 1 μ s) by the noise simulator		
Vibration	0.75 mm double amplitude at frequency of 10 to 55 Hz (for 1 minute) in each X, Y, Z direction for 1 hours		
Vibration (malfunction)	0.5 mm double amplitude at frequency of 10 to 55 Hz (for 1 minute) in each X, Y, Z direction for 10 min		
Shock	300 m/s ² (≈ 30 G) in each X, Y, Z direction for 3 times		
Shock (malfunction)	100 m/s ² (≈ 10 G) in each X, Y, Z direction for 3 times		
Relay life cycle	Mechanical: $\geq 10,000,000$ operations Electrical: $\geq 100,000$ operations (250 VAC \sim 3A resistive load)		
Ambient temperature	-10 to 50 $^{\circ}$ C, storage: -25 to 65 $^{\circ}$ C (no freezing or condensation)		
Ambient humidity	35 to 85 %RH, storage: 35 to 85 %RH (no freezing or condensation)		

01) Power supply 24 - 70 VDC \approx , 100 - 240 VAC \sim 50 / 60 Hz options are also available to order.

Panel Meters

(Indicator)

M4Y Series



Features

- Max. display value: 1999
- Auto-zero function and hold display value function
- Linear display based on input specification
- Display output values (0 - 10 VDC \approx) from power converters (options available for DC 4 - 20 mA, 1 - 5 VDC \approx)
- RMS or AVG value selection (AC voltage)
- 7-segment LED display
- DIN standard size models

Specifications

Input type	DC voltage	AC voltage	DC current	AC current	Power	Rotation, speed	Scaling
Max. allowable input	≤ 300 VDC \approx	≤ 400 VAC \sim	$\leq DC 2 A$	$\leq AC 5 A$	≤ 10 VDC \approx	≤ 10 VDC \approx ≤ 10 VAC \sim	DC 4 - 20 mA
	$\approx 150\%$ F.S. for each measured input range ⁰¹⁾						
Display method	7-segment (red) LED (character height: 14 mm)						
Display accuracy	Dependent on the input type						
DC input	$\pm 0.2\%$ F.S. rdg ± 1 -digit						
AC input	$\pm 0.5\%$ F.S. rdg ± 1 -digit						
Display scale	1999						
Sampling time	2.5 times / sec						
Response speed	≈ 2 sec (0 to 1999)						
Sampling cycle	300 ms						
Operation method	Dual integral method						
Unit weight	≈ 144 g						
Approval	EAC						
⁰¹⁾ At 400 VAC \sim input: $\approx 120\%$ F.S. for each measured input range							
Power supply ⁰¹⁾	100 - 240 VAC \sim $\pm 10\%$ 50 / 60 Hz						
Power consumption	Dependent on the input type						
DC input	2 W						
AC input	4 VA						
Insulation resistance	$\geq 100 M\Omega$ (500 VDC \approx megger)						
Dielectric strength	2,000 VAC \sim 50 / 60 Hz for 1 min						
Noise immunity	± 1 kV square wave noise (pulse width: 1 μ s) by the noise simulator						
Vibration	0.75 mm double amplitude at frequency of 10 to 55 Hz (for 1 minute) in each X, Y, Z direction for 1 hours						
Vibration (malfunction)	0.5 mm double amplitude at frequency of 10 to 55 Hz (for 1 minute) in each X, Y, Z direction for 10 min						
Shock	300 m/s ² ($\approx 30 G$) in each X, Y, Z direction for 3 times						
Shock (malfunction)	100 m/s ² ($\approx 10 G$) in each X, Y, Z direction for 3 times						
Ambient temperature	-10 to 50 °C, storage: -25 to 65 °C (no freezing or condensation)						
Ambient humidity	35 to 85 %RH, storage: 35 to 85 %RH (no freezing or condensation)						

⁰¹⁾ Power supply 24 - 70 VDC \approx option is also available to order.

Panel Meters

(Indicator)

M5W Series



Features

- Max. display value: 19999
- Linear display based on input specification
- Display output values (0 - 10 VDC $\overline{=}$) from power converters (options available for DC 4 - 20 mA, 1 - 5 VDC $\overline{=}$)
- RMS or AVG value selection (AC voltage)
- 7-segment LED display
- DIN standard size models

Specifications

Input type	DC voltage	DC current	Power	Rotation, speed	Scaling
Max. allowable input	≤ 300 VDC $\overline{=}$	\leq DC 2 A	≤ 10 VDC $\overline{=}$	≤ 10 VDC $\overline{=}$	DC 4 - 20 mA
	≈ 150 % F.S. for each measured input range				
Display method	7-segment (red) LED (character height: 14 mm)				
Display accuracy	± 0.2 % F.S. rdg ± 1 -digit				
Display scale	19999				
Sampling time	2.5 times / sec				
Response speed	≈ 2 sec (0 to 19999)				
Sampling cycle	300 ms				
Operation method	Dual integral method				
Unit weight	≈ 172 g				
Approval	EAC				
Power supply ⁰¹⁾	100 - 240 VAC \sim ± 10 % 50 / 60 Hz				
Power consumption	2 W				
Insulation resistance	≥ 100 M Ω (500 VDC $\overline{=}$ megger)				
Dielectric strength	2,000 VAC \sim 50 / 60 Hz for 1 min				
Noise immunity	± 1 the square wave noise (pulse width: 1 μ s) by the noise simulator				
Vibration	0.75 mm double amplitude at frequency of 10 to 55 Hz (for 1 minute) in each X, Y, Z direction for 1 hours				
Vibration (malfunction)	0.5 mm double amplitude at frequency of 10 to 55 Hz (for 1 minute) in each X, Y, Z direction for 10 min				
Shock	300 m/s ² (≈ 30 G) in each X, Y, Z direction for 3 times				
Shock (malfunction)	100 m/s ² (≈ 10 G) in each X, Y, Z direction for 3 times				
Ambient temperature	0 to 50 $^{\circ}$ C, storage: -25 to 65 $^{\circ}$ C (no freezing or condensation)				
Ambient humidity	35 to 85 %RH, storage: 35 to 85 %RH (no freezing or condensation)				

01) Power supply 24 - 70 VDC $\overline{=}$ option is also available to order.



Loop-Power Panel Meters (Indicator)

M4NS / M4YS Series



Features

- Loop-powered: power supplied by loop current
- Measured input: DC 4 - 20 mA
- Display range: -1999 to 9999
- High / low-limit display scale function
- Decimal point setting function
- Input high / low-value correction function
- Display peak value monitoring function
- Set peak value monitoring delay time
- Display cycle time setting
(0.5 / 1 / 2 / 3 / 4 / 5 seconds)
- Error display function
 - M4NS: DIN W 48 × H 24 mm
 - M4YS: DIN W 72 × H 36 mm

Specifications

Model	M4NS-NA	M4YS-NA
Input type	DC 4 - 20 mA	
Impedance between input lines ⁰¹⁾	≤ 600 Ω	
Display method	7-segment (red) LED (character height: 10 mm)	7-segment (red) LED (character height: 14 mm)
Display accuracy	Dependent on the ambient temperature	
	25 ± 5 °C	0.3 % F.S. rdg ± 1-digit
	-10 to 50 °C	0.4 % F.S. rdg ± 1-digit
Display scale	-1999 to 9999 (4-digit)	
Display cycle	0.5, 1, 2, 3, 4, 5 sec	
Resolution	1 / 12,000	
Unit weight	≈ 44 g	≈ 110 g
Approval	EBC	
01) Based on input power 24 VDC≡		
Power supply	Loop powered type	
Insulation resistance	≥ 100 MΩ (500 VDC≡ megger)	
Dielectric strength	2,000 VAC~ 50 / 60 Hz for 1 min	
Vibration	0.75 mm double amplitude at frequency of 10 to 55 Hz (for 1 minute) in each X, Y, Z direction for 1 hours	
Vibration (malfunction)	0.5 mm double amplitude at frequency of 10 to 55 Hz (for 1 minute) in each X, Y, Z direction for 10 min	
Shock	300 m/s ² (≈ 30 G) in each X, Y, Z direction for 3 times	
Shock (malfunction)	100 m/s ² (≈ 10 G) in each X, Y, Z direction for 3 times	
Ambient temperature	-10 to 50 °C, storage: -25 to 60 °C (no freezing or condensation)	
Ambient humidity	35 to 85 %RH, storage: 35 to 85 %RH (no freezing or condensation)	

Digital Panel Meters

for Mosaic Panels

(Indicator)

M4V Series



Features

- Various input options:
0 - 2 VDC $\overline{=}$, 0 - 10 VDC $\overline{=}$, 1 - 5 VDC $\overline{=}$,
DC 0 - 1 mA, DC 4 - 20 mA
- High / low-limit display scale function
- Display range: -999 to 9999
- Display accuracy: F.S. \pm 2 % rdg \pm 1-digit
- Error display function
- Built-in microprocessor

Specifications

Model	M4V
Input type	DC voltage, DC current
Measurement input type	0 - 2 VDC $\overline{=}$, 1 - 5 VDC $\overline{=}$, 0 - 10 VDC $\overline{=}$, DC 0 - 1 mA, DC 4 - 20 mA
Max. allowable input	\approx 110 % F.S. for each measured input range
Display method	7 -segment (red) LED (character height: 14 mm)
Display accuracy	Dependent on the ambient temperature
0 to 50 °C	\pm 0.2 % F.S. rdg \pm 1-digit
-10 to 0 °C	\pm 0.3 % F.S. rdg \pm 1-digit
Display cycle	0.5 sec
Unit weight	\approx 83 g
Approval	ERC
Power supply	12 - 24 VDC $\overline{=}$ \pm 10 %
Power consumption	\leq 2 W
Insulation resistance	\geq 100 M Ω (500 VDC $\overline{=}$ megger)
Dielectric strength	2,000 VAC \sim 50 / 60 Hz for 1 min
Noise immunity	\pm 300 V square wave noise (pulse width: 1 μ s) by the noise simulator
Vibration	0.75 mm double amplitude at frequency of 10 to 55 Hz (for 1 minute) in each X, Y, Z direction for 1 hours
Vibration (malfunction)	0.5 mm double amplitude at frequency of 10 to 55 Hz (for 1 minute) in each X, Y, Z direction for 10 min
Shock	300 m/s ² (\approx 30 G) in each X, Y, Z direction for 3 times
Shock (malfunction)	100 m/s ² (\approx 10 G) in each X, Y, Z direction for 3 times
Ambient temperature	-10 to 50 °C, storage: -20 to 60 °C (no freezing or condensation)
Ambient humidity	35 to 85 %RH, storage: 35 to 85 %RH (no freezing or condensation)

Revolutions / Frequency Pulse Meters (Indicator)

LR5N-B Series



Features

- 1-pulse input per revolution
- Display up to 10,000 RPM
- Built-in internal battery (power supply not required)
- Display RPM or RPS of rotating shaft or disc
- AC voltage frequency display function
- IP66 protection structure (front panel)

Specifications

Model	LR5N-B		
Display digits	4½-digit		
Display type	LCD Zero Blanking (character size: H 8.7 mm)		
Input type	IN 1: No-voltage input	IN 2: Voltage input 1	IN 3: Voltage input 2
Input signal level	Short-residual voltage : ≤ 0.5 V Short-circuit impedance : ≤ 10 kΩ Open-circuit impedance : ≥ 500 kΩ	High input voltage range : 4.5 - 30 VDC= Low input voltage range : 0 - 2 VDC= Voltage: 3 - 30 VAC~	30 - 240 VAC~
HOLD	YES		
Unit weight (packaged)	≈ 59 g (≈ 91.5 g)		
Power supply	Built-in battery (CR2477)		
Battery life cycle	≥ 3 years (at ≈ 20 °C)		
Insulation resistance	≥ 100 MΩ (500 VDC= megger)		
Dielectric strength	2,000 VAC~ 50 / 60 Hz for 1 min (Cutoff current = 10 mA)		
Vibration	0.75 mm double amplitude at frequency of 10 to 55Hz (for 1 minute) in each X, Y, Z direction for 1 hour		
Vibration (malfunc.)	0.3 mm double amplitude at frequency of 10 to 55 Hz (for 1 minute) in each X, Y, Z direction for 10 minute		
Shock	300 m/s ² (≈ 30 G) in each X, Y, Z direction for 3 times		
Shock (malfunc.)	100 m/s ² (≈ 10 G) in each X, Y, Z direction for 3 times		
Ambient temp.	-10 to 55 °C, storage: -25 to 65 °C (no freezing or condensation)		
Ambient humid.	35 to 85 %RH, storage: 35 to 85 %RH (no freezing or condensation)		
Protection rating	IP66 (when using waterproof rubber for front panel), terminal cover (finger protector)		
Display unit	Display range	Display accuracy	
RPM	1 to 10000 RPM	1 to 5000 RPM: F.S. ± 0.05 % ± 1-digit 5001 to 10000 RPM: F.S. ± 0.1 % ± 1-digit	
0.1RPM	0.1 to 1000.0 RPM	F.S. ± 0.05 % ± 1-digit	
Hz	1 to 1000 Hz	F.S. ± 0.1 % ± 1-digit	
0.1Hz	0.1 to 100.0 Hz		
RPS	1 to 1000 RPS		

Thumbwheel Switch Multi Pulse Meters

MP5M Series



Features

- 14 operation modes
 - Frequency / revolutions / speed, passing speed, cycle, passing time, time interval
 - Time differential, absolute ratio, density, length measurement 1 / 2, interval
 - Accumulation, addition / subtraction (individual input), addition / subtraction (phase difference input)
- Various output models
 - Relay single (high-limit) / double (high / low-limit) + NPN open collector output
- Various functions
 - Prescale, monitoring delay, hysteresis, auto-zero, parameter lock
- NPN input (non-contact / contact) or PNP input (non-contact / contact)
- Display range: -19999 to 99999
- Various display units
- Power supply
 - 100 - 240 VAC ~ 50 / 60 Hz (AC type)
 - 24 VAC ~ 50 / 60 Hz, 24 - 48 VDC (AC / DC type)

Specifications

Series	MP5M-□N	MP5M-□1	MP5M-□2
Input signal ⁽⁰¹⁾	Solid state input 1: ≤ 50 kHz (pulse width: ≥ 10 μ s) Solid state input 2 ⁽⁰²⁾ : ≤ 5 kHz (pulse width: ≥ 100 μ s) Contact input: ≤ 45 Hz (contact: ≥ 12 VDC = 5 mA, pulse width: ≥ 11 ms)		
Voltage input	Input impedance: 3.9 k Ω , [H]: 4.5 - 24 VDC =, [L]: 0 - 1 VDC =		
No-voltage input	Short-circuit impedance: ≤ 80 Ω , residual voltage: ≤ 1 VDC =, open-circuit impedance: ≥ 100 k Ω		
Display method	7-segment LED (zero blanking method)		
Character size	W 4 × H 8 mm		
Prescale	0.0001 × 10 ⁻⁹ to 9.9999 × 10 ⁹		
Hysteresis	-	0 to 9999 ⁽⁰³⁾	
Display cycle	OFF ⁽⁰⁴⁾ , 0.05, 0.5, 1, 2, 4, 8 sec (same as update output cycle)		
Display range	-19999 to 99999		
Contact control output	Relay		
Type	-	1c × 1	1a × 2
Capacity	-	250 VAC ~ 3 A, 30 VDC = 3 A resistive load	250 VAC ~ 3 A, 30 VDC = 3 A resistive load
Solid-state control output	NPN open collector		
Type	-	× 1	× 2
Capacity	-	≤ 30 VDC = 100 mA	≤ 30 VDC = 100 mA
Approval	CE		
Unit weight (package)	≈ 168 g (≈ 243 g)	≈ 181 g (≈ 256 g)	≈ 190 g (≈ 265 g)

01) Standard duty ratio 1:1

02) Operation mode F7, F8: ≤ 1 kHz (pulse width: ≥ 500 μ s)

03) The hysteresis setting range varies according to the decimal point setting position.

04) Only available operation mode F2, F14

Input	AC voltage	AC / DC voltage
Power supply	100 - 240 VAC ~ ± 10 % 50 / 60 Hz	24 VAC ~ ± 10 % 50 / 60 Hz, 24 - 48 VDC = ± 10 %
Power consumption	≤ 9 VA	AC: ≤ 6.5 VA, DC: ≤ 5 W
External power supply	≤ 12 VDC = ± 10 % 80 mA	
Memory retention	Number of inputs: 100,000 operations (non-volatile semiconductor memory type)	
Relay life cycle	Mechanical: $\geq 5,000,000$ operations Electrical: $\geq 100,000$ operations (250 VAC ~ 3 A resistive load)	
Insulation resistance	≥ 100 M Ω (500 VDC = megger)	
Dielectric strength	2,000 VAC ~ 60 Hz for 1 min	
Noise immunity	± 2 kV the square wave noise (pulse width: 1 μ s) by the noise simulator	
Vibration	0.75 mm double amplitude at frequency of 10 to 55 Hz in each X, Y, Z direction for 1 hour	
Vibration (malfunction)	0.5 mm double amplitude at frequency of 10 to 55 Hz in each X, Y, Z direction for 10 min	
Shock	300m / s ² (≈ 30 G) in each X, Y, Z direction for 3 times	
Shock (malfunction)	100m / s ² (≈ 30 G) in each X, Y, Z direction for 3 times	
Ambient temperature	-10 to 50 °C, storage: -20 to 60 °C (no freezing or condensation)	
Ambient humidity	35 to 85 %RH, storage: 35 to 85 %RH (no freezing or condensation)	

Multi Pulse Meters

MP5S / MP5Y / MP5W Series



Features

- 16 operation modes
 - Frequency / revolutions / speed, passing speed, cycle, passing time, time interval
 - Time differential, absolute ratio, error ratio, density, error, length measurement 1 / 2, interval
 - Accumulation, addition / subtraction (individual input), addition / subtraction (phase difference input)
- Various output models
 - Relay triple / quintuple output, NPN / PNP open collector quintuple output
 - BCD Dynamic output, PV transmission output (current output)
 - RS485 communication output (Modbus RTU)
- Various function
 - Prescale, delay monitoring, hysteresis, auto-zero, parameter lock, data bank (MP5W only)
- Display range: -19999 to 99999
- Various display units

Specifications

Series	MP5S	MP5Y	MP5W
Input signal ⁰¹⁾	Solid state input 1: ≤ 50 kHz (pulse width: ≥ 10 μ s) Solid state input 2 ⁰²⁾ : ≤ 5 kHz (pulse width: ≥ 100 μ s) Contact input: ≤ 45 Hz (contact: 12 VDC \Rightarrow ≥ 5 mA, (pulse width: ≥ 11 ms)		
Voltage input	Input impedance: 3.9 k Ω , [H]: 4.5 - 24 VDC \Rightarrow , [L]: 0 - 1 VDC \Rightarrow		
No-voltage input	Short-circuit impedance: ≤ 80 Ω , residual voltage: ≤ 1 VDC \Rightarrow , open-circuit impedance: ≥ 100 k Ω		
Display method	7-segment LED (zero blanking method)		
Character size	W 4 × H 8 mm	W 7 × H 14 mm	
Prescale	0.0001 × 10 ⁹ to 9.9999 × 10 ⁹		
Hysteresis	0 to 9999 ⁰³⁾		
Display cycle	OFF ⁰⁴⁾ , 0.05, 0.5, 1, 2, 4, 8 sec (same as update output cycle)		
Display range	-19999 to 99999		
Output	Depending on models		
Relay	250 VAC \sim 3 A, 30 VDC \Rightarrow 3 A resistive load		
NPN / PNP open collector	≤ 30 VDC \Rightarrow 30 mA		
BCD Dynamic	NPN open collector ≤ 30 VDC \Rightarrow 30 mA (Dynamic COM cycle (T) = 40 ms)		
PV transmission	DC 4 - 20 mA (load: ≤ 500 Ω , resolution: 8,000 divisions) / DC 0 - 20 mA (load: ≤ 500 Ω , resolution: 10,000 divisions)		
RS485 communication	Modbus RTU		
Product components	Product, instruction manual		
Bracket	Mounted	× 2	× 2
Unit sticker	× 1	× 1	× 2
Unit weight (package)	≈ 132 g (≈ 191 g)	≈ 140 g (≈ 230 g)	≈ 210 g (≈ 334 g)
Approval	CE		

01) Standard duty ratio 1:1

02) Operation mode F7, F8, F9, F10: ≤ 1 kHz (pulse width: ≥ 500 μ s)

03) The hysteresis setting range varies according to the decimal point setting position.

04) Only available operation mode F2, F16

Input	AC voltage	AC / DC voltage
Power supply	100 - 240 VAC \sim ± 10 % 50 / 60 Hz	24 VAC \sim ± 10 % / 50 / 60 Hz, 24 - 48 VDC \Rightarrow ± 10 %
Power consumption	Depending on Series / power supply	
MP5S	≤ 7.5 VA	AC: ≤ 6 VA, DC: ≤ 4.5 W
MP5Y	≤ 9 VA	AC: ≤ 7 VA, DC: ≤ 6.2 W
MP5W	≤ 15 VA	AC: ≤ 11 VA, DC: ≤ 7 W
External power supply	≤ 12 VDC \Rightarrow ± 10 % 80 mA	
Sub power supply ⁰¹⁾	≤ 24 VDC \Rightarrow 30 mA	
Memory retention	Number of inputs: 100,000 operations (non-volatile semiconductor memory type)	
Relay life cycle	Mechanical: $\geq 10,000,000$ operations (switching frequency 180 operations / min) Electrical: $\geq 100,000$ operations (250 VAC \sim 3 A, 30 VDC \Rightarrow 3 A resistive load) (switching frequency 20 operations / min)	
Insulation resistance	≥ 100 M Ω (500 VDC \Rightarrow megger)	
Dielectric strength	2,000 VAC \sim 60 Hz for 1 min	
Noise immunity	± 2 kV the square wave noise (pulse width: 1 μ s) by the noise simulator	
Vibration	0.75 mm double amplitude at frequency of 10 to 55 Hz in each X, Y, Z direction for 1 hour	
Vibration (malfunction)	0.5 mm double amplitude at frequency of 10 to 55 Hz in each X, Y, Z direction for 10 min	
Shock	300m / s ² ($\approx 30G$) in each X, Y, Z direction for 3 times	
Shock (malfunction)	100m / s ² ($\approx 30G$) in each X, Y, Z direction for 3 times	
Ambient temperature	-10 to 50 $^{\circ}$ C, storage: -20 to 60 $^{\circ}$ C (no freezing or condensation)	
Ambient humidity	35 to 85 %RH, storage: 35 to 85 %RH (no freezing or condensation)	
Comm. protocol	Modbus RTU (16-bit CRC)	

01) Only for MP5W



E3. Digital Display Units

Digital display units are available in various sizes, can display over 60 different characters and signals for various monitoring purposes.

E3-1	Display Units	DS / DA Series	High Performance Display Units (Serial / Parallel Input)
			High Performance Display Units (RS485 Input)
		D1AA Series	W 11 × H 22 mm 16-Segment Display Units
		D1SA Series	W 11 × H 22 mm 7-Segment Display Units
		D1SC-N Series	W 32 × H 57 mm 7-Segment Display Units
E3-2	Panel Mount Display Units	D5Y / D5W Series	Panel Mount 5 Digit Display Units

High Performance

Display Units

(Serial / Parallel Input)

DS / DA Series



Features

- Simple wiring without soldering
 - multi-stage connection using expansion connectors or ribbon cables
 - power supply and data wiring required on base unit only
- Various input options
 - Serial input
 - Dynamic Parallel input
 - RS485 communication (Modbus) input (Master, Slave)
 - RS485 communication (Modbus) time sync display
 - PT temperature sensor input
 - PT temperature sensor + RS485 communication input
- Expandable up to 24 units with multi-stage connection
- Available in various sizes: 16 mm, 22.5 mm, 40 mm, 60 mm
- High luminance LED display
- Various unit display plates (switchable) with flashing or ON / OFF options
- Various display types
 - 7-segment display and 16-segment
 - Red and green display types
 - Display 64 characters (0 to 9, A to Z, 27 symbols, decimal point)

Specifications

Model	DS16-□□	D□22-□□	D□40-□□	D□60-□□
Display color	Red / green model			
Power supply	12 - 24 VDC≒			
Allowable voltage range	90 to 110 % of power supply			
Current consumption (red)	≤ 20 mA	≤ 25 mA	≤ 55 mA	≤ 65 mA
Current consumption (green)	≤ 15 mA	≤ 20 mA	≤ 40 mA	≤ 45 mA
Characters size (W×H)	9 × 16 mm	11.2 × 22.5 mm	22.4 × 40 mm	33.6 × 60 mm
Noise immunity	± 500 V the square wave noise (pulse width: 1 μs) by the noise simulator			
Ambient temperature	-10 to 55 °C, storage: -25 to 65 °C (no freezing or condensation)			
Ambient humidity	35 to 85 %RH, storage: 35 to 85 %RH (no freezing or condensation)			
Protection rating	IP40 (front part)			
Approval	CE ENEC			
Weight (packaged) ⁰¹⁾	≈ 12 g (≈ 52 g)	≈ 17 g (≈ 58 g)	≈ 28 g (≈ 63 g)	≈ 60 g (≈ 110 g)

⁰¹⁾ The package weight of 16 mm / 22 mm expansion unit varies, it based on 3 packages.
16 mm: ≈ 77 g / 22 mm: ≈ 92 g

Model	D□□-□S	D□□-□P
Input method	Serial	Parallel
Max. Clock ⁰¹⁾	≤ 2 kHz	Dynamic 1: ≤ 3 kHz Dynamic 2: ≤ 1.5 kHz
Input logic	Positive logic (PNP), negative logic (NPN)	
Input resistance	20 kΩ	
Input level	High: 4.5 - 24 VDC≒, Low: 0 - 1.2 VDC≒	
Display character	64 characters and symbols display: 0 to 9, A to Z, 27 symbols, decimal point	
Max. number of multi-stage	24-unit	Dynamic 1: 6-unit (4-bit) or 4 units (6-bit) Dynamic 2: 24-unit (6-bit)

⁰¹⁾ Based on 50 : 50 (%) of duty ratio (ON / OFF)

High Performance

Display Units

(RS485 Input)

DS / DA Series



Features

- Simple wiring without soldering
 - multi-stage connection using expansion connectors or ribbon cables
 - power supply and data wiring required on base unit only
- Various input options
 - Serial input
 - Dynamic Parallel input
 - RS485 communication (Modbus) input (Master, Slave)
 - RS485 communication (Modbus) time sync display
 - PT temperature sensor input
 - PT temperature sensor + RS485 communication input
- Expandable up to 24-units with multi-stage connection
- Available in various sizes: 16 mm, 22.5 mm, 40 mm, 60 mm
- High luminance LED display
- Various unit display plates (switchable) with flashing or ON / OFF options
- Various display types
 - 7-segment display and 16-segment
 - Red and green display types
 - Display 64 characters (0 to 9, A to Z, 27 symbols, decimal point)

Specifications

Model	DS16-□□	D□22-□□	D□40-□□	D□60-□□
Display color	Red / green model			
Power supply	12 - 24 VDC==			
Allowable voltage range	90 to 110 % of power supply			
Current consumption (red)	≤ 20 mA	≤ 25 mA	≤ 55 mA	≤ 65 mA
Current consumption (green)	≤ 15 mA	≤ 20 mA	≤ 40 mA	≤ 45 mA
Size (W×H)	9 × 16 mm	11.2 × 22.5 mm	22.4 × 40 mm	33.6 × 60 mm
Noise immunity	±500 V the square wave noise (pulse width: 1 μs) by the noise simulator			
Ambient temperature	-10 to 55 °C, storage: -25 to 65 °C (non freezing or condensation)			
Ambient humidity	35 to 85%RH, storage: 35 to 85%RH (non freezing or condensation)			
Protection rating	IP40 (front part)			
Approval	CE ENEC			
Weight (packaged) ⁰¹⁾	≈ 12 g (= 52 g)	≈ 17 g (= 58 g)	≈ 28 g (= 63 g)	≈ 60 g (= 110 g)
Comm. protocol	Modbus RTU			

01) The package weight of 16 mm / 22 mm expansion unit varies, it based on 3 packages.
16 mm: ≈ 77 g / 22 mm: ≈ 92 g

Model	D□□-□T	DS□-□C
Input method	RS485 communication	RS485 communication (time)
Directly connected Autonics Series	CT6, CT4, MP5, MT4, TK / TX, TM2, TM4, THD	-
Display character (range)	64 characters and symbols display: 0 to 9, A to Z, 27 symbols, decimal point	World local time, 12/24-hour, summer time
Max. number of multi-stage	24-unit	10-unit
Comm. protocol	Modbus RTU	

W 11 × H 22 mm

16-Segment

Display Units

D1AA Series



Features

- Displays 61 types of characters and signs (0 to 9, A to Z, 24 symbols, decimal point)
- Selectable input logic (positive / negative), data input type (parallel / serial)
- 16-segment in red/green
- Wide range of input signal level (Low : 0 - 1.2 VDC \equiv , High : 4.5 - 24 VDC \equiv)
- 12 - 24 VDC \equiv power supply
- Multi-stage connection available

Specifications

Model	D1AA-RN	D1AA-GN
Display method	16-segment LED (red)	16-segment LED (green)
Power supply	12 - 24 VDC \equiv	
Allowable voltage range	90 to 110 % of power supply	
Current consumption	\leq 32 mA	
Size	W 11 × H 22 mm	
Display character	61 characters and symbols (0 to 9, A to Z, 24 symbols, decimal point)	
Input	Parallel: Parallel 6 bits data, LATCH, decimal point Serial : Serial 6 / 7 bits data, CLOCK, LATCH, decimal point ⁰¹⁾	
Input resistance	20 k Ω	
Input level	High: 4.5 - 24 VDC \equiv , Low: 0 - 1.2 VDC \equiv	
Max. Clock ⁰²⁾	\leq 3 kHz	
Output	Data output (serial input)	
Input logic	Positive logic (PNP), negative logic (NPN) selectable (by inner soldering)	
Noise immunity	\pm 300 V the square wave noise (pulse width: 1 μ s) by the noise simulator	
Ambient temperature	0 to 60 °C, storage: -10 to 85 °C (no freezing or condensation)	
Ambient humidity	35 to 85 %RH (no freezing or condensation)	
Accessory	Connector (CT-10S)	
Approval	ERC	
Weight (packaged) ⁰³⁾	\approx 16 g (\approx 131 g)	

01) When applying the serial 6 bits input.

02) Max. Clock is for 1:1 of duty ratio (ON, OFF ratio).

03) The package weight is based on four.

W 11 × H 22 mm

7-Segment

Display Units

D1SA Series



Features

- Selectable decimal (0 to 9) / hexadecimal (0 to 9, A to F) display, input logic (positive / negative), data input method (serial / parallel)
- 7-segment, red / green display
- 12 - 24 VDC \equiv power supply
- Wide range on signal input voltage level (Low: max. 0 - 1.2 VDC \equiv , High: 4.5 - 24 VDC \equiv)
- Easy multi-stages connection
- Zero Blanking function

Specifications

Model	D1SA-RN	D1SA-GN
Display method	7-segment LED (red)	7-segment LED (green)
Power supply	12 - 24 VDC \equiv	
Allowable voltage range	90 to 110 % of power supply	
Current consumption	≤ 35 mA	
Size	W 11 × H 22 mm	
Display character	Decimal number: 0 to 9, decimal point Hexadecimal number: 0 to 9, A to F, decimal point	
Input	Parallel: Parallel 4-bit data, LATCH, Zero Blanking, decimal point Serial: Serial 4 / 5-bit data, CLOCK, Zero Blanking, LATCH, decimal point ⁰¹⁾	
Input resistance	20 kΩ	
Input level	High: 4.5 - 24 VDC \equiv , Low: 0 - 1.2 VDC \equiv	
Max. Clock ⁰²⁾	≤ 3 kHz	
Output	Data output (serial input), Zero Blanking output	
Input logic	Positive logic (PNP), negative logic (NPN) selectable (function set switches)	
Noise immunity	Between power terminals or input terminals : ± 300 V the square wave noise (pulse width: 1 μs) by the noise simulator	
Ambient temperature	0 to 60 °C, storage: -10 to 85 °C (no freezing or condensation)	
Ambient humidity	35 to 85 %RH (no freezing or condensation)	
Accessory	Connector (CT-10S)	
Approval	EAC	
Weight (packaged) ⁰³⁾	≈ 16 g (≈ 131 g)	

01) When applying the serial 4-bit input.

02) Max. Clock is for 50 : 50 (%) of duty ratio (ON, OFF ratio).

03) The package weight is based on four.

W 32 × H 57 mm

7-Segment

Display Units

D1SC-N Series



Features

- Selectable decimal (0 to 9) / hexadecimal (0 to 9, A to F) display, input logic (positive / negative), data input method (serial / parallel)
- 12 - 24 VDC \pm power supply
- Wide range on signal input voltage level (Low: max. 0 - 1.2 VDC \pm , High: 4.5 - 24 VDC \pm)
- Zero Blanking function

Specifications

Model	D1SC-N
Display method	7-segment LED (red)
Power supply	12 - 24 VDC \pm
Allowable voltage range	90 to 110 % of power supply
Current consumption	\leq 70 mA
Character size (W×H)	32 × 57 mm
Display character	Decimal number: 0 to 9, decimal point, Minus Hexadecimal number: 0 to 9, A to F, decimal point, Minus
Input method	Parallel: Parallel 4-bit data, LATCH, Zero Blanking, decimal point Serial : Serial 4/5-bit data, CLOCK, Zero Blanking, LATCH, decimal point ⁰¹⁾
Input resistance	12 k Ω
Input level	High: 4.5 - 24 VDC \pm , Low: 0 - 1.2 VDC \pm
Max. Clock ⁰²⁾	\leq 3 kHz
Output	Data output (serial input), Zero Blanking output
Input logic	Positive logic (PNP), negative logic (NPN) selectable (function set switches)
Insulation resistance	\geq 100 M Ω (500 VDC \pm megger)
Noise immunity	Between the power terminals or input terminals: \pm 300 V the square wave noise (pulse width: 1 μ s) by the noise simulator
Ambient temperature	0 to 60 °C, storage: -10 to 85 °C (no freezing or condensation)
Ambient humidity	35 to 85 %RH (no freezing or condensation)
Approval	ERC
Weight	\approx 100 g

01) When applying the serial 4-bit input.

02) Max. Clock is for 50 : 50 (%) of duty ratio (ON, OFF ratio).

Panel Mount 5 Digit Display Units

D5Y / D5W Series



Features

- Various input specifications
 - Static Parallel input, Dynamic Parallel input, 4 / 5-bit Serial input, 16 / 20 / 25-bit
- Serial input method
- Decimal point, minus sign display selection function
 - Display type by serial input, external DP terminal and Minus terminal
- Positive / negative logic input selection function
- Display digit selection function
 - 4-digit (-9999 to 9999), 5-digit (0 to 99999)
- Zero blanking function selection function
- Selectable reversion function of latch signal

Specifications

Model	D5Y-M	D5W-M	D5W-MX
Power supply	12 - 24 VDC≐		110 / 220 VAC~ 50 / 60 Hz
Allowable voltage range	90 to 110 % of power supply		
Current consumption	1.1 W		2 VA
Size (W×H)	DIN 72 × 36 mm	DIN 96 × 48 mm	
Display method	7-segment LED Display		
Display digit / display range	4-digit / -9999 to 9999		
	5-digit ⁰¹⁾ / 0 to 99999		
Max. response CLOCK	100 Hz to 5 kHz ⁰¹⁾		
Input level	High: 5 - 24 VDC≐, Low: 0 - 1.2 VDC≐		
Input logic	Positive logic (PNP), negative logic (NPN)		
Input method	Static, Dynamic, 4 / 5-bit serial, Serial (16 / 20 / 25-bit)		
Insulation resistance	100 MΩ (500 VDC≐ megger)		
Dielectric strength	2000 VAC~ 50 / 60 Hz for 1 min		
Noise immunity	±1 kV the square wave noise (pulse width: 1 μs) by the noise simulator		
Vibration	0.75 mm double amplitude at frequency of 10 to 55 Hz (for 1 min) in each of X, Y, Z directions for 1 hour		
Vibration (malfunction)	0.5 mm double amplitude at frequency of 10 to 55 Hz (for 1 min) in each of X, Y, Z directions for 10 min		
Shock	300 m / s ² (≈ 30 G) in X, Y, Z directions for 3 times		
Shock (malfunction)	100 m / s ² (≈ 10 G) in X, Y, Z directions for 3 times		
Ambient temperature	-10 to 50 °C, storage: -25 to 65 °C (no freezing or condensation)		
Ambient humidity	35 to 85 %RH, storage: 35 to 85 %RH (no freezing or condensation)		
Approval	EAC		
Weight	≈ 75 g	≈ 165 g	≈ 267 g

01) Except for Static input method



E4. Sensor Controllers

Sensors controllers are used to apply various forms of logic and functions to input signals from sensors and transmit relay or transistor signals.

E4-1 Sensor Controllers

PA10 Series

Sensor Controllers

PA-12 Series

8-Pin Plug Sensor Controllers

Sensor Controllers

PA10 Series



Features

- High-speed output response
- DIN rail or panel mount installation
- Various models
 - PA10-V: general-purpose controllers
 - PA10-W: 2-channel controllers
 - PA10-U: high performance controllers
- PA10-U features
 - 13 operation modes (DIP switches)
 - Flip-flop mode for level control
 - Timer operation mode
- Wide range power supply:
 - 100 - 240 VAC ~ 50 / 60 Hz

Specifications

Model	PA10-U	PA10-V□	PA10-W□
Power supply	100 - 240 VAC ~ ± 10 % 50 / 60 Hz		
Power consumption	≤ 10 VA (12 VDC = / 200 mA load)		
Sensor supply power	12 VDC = ± 10 % ≈ 200 mA ⁰¹⁾		
Input logic	AND, OR (switch)	AND	Individual
Input method	NPN input		
No-voltage input	Short-circuit impedance: ≤ 680 Ω Short-circuit residual voltage: ≤ 0.8 V Open-circuit impedance: ≥ 100 kΩ	Short-circuit impedance: ≤ 300 Ω Short-circuit residual voltage: ≤ 2 V Open-circuit impedance: ≥ 100 kΩ	
Voltage input	-	Input impedance: 5.6 kΩ [H]: 5 - 30 VDC = [L]: 0 - 2 VDC =	
Output	O.C OUT1 / 2	O.C OUT1	OUT1, OUT2
Contact output	250 VAC ~ 3 A resistance load		
Solid-state output	NPN open collector output ≤ 30 VDC =, ≤ 100 mA		-
Output response time	Relay output: ≤ 10 ms, Transistor output: ≤ 0.05 ms		
Function	Operation mode (1 to 12, DIP switch)	-	-
Relay life cycle	Mechanical: Min. 10,000,000 times Electrical: Min. 100,000 times (250 VAC ~ 3 A resistance load)		
Dielectric strength	2000 VAC ~ 50 / 60 Hz for 1 min		
Insulation resistance	≥ 100 MΩ (500 VDC = megger)		
Ambient temperature	-10 to 55 °C, storage: -25 to 60 °C (no freezing or condensation)		
Ambient humidity	35 to 85 %RH, storage: 35 to 85 %RH (no freezing or condensation)		
Approval	EHC		
Unit weight	≈ 150 g		≈ 160 g

01) If the load is connected over 200 mA at the sensor output, it may cause mechanical trouble.

8-Pin Plug

Sensor Controllers

PA-12 Series



Features

- 110 / 220 VAC~ dual voltage
- NPN / PNP input switch
- High contact capacity
(250 VAC~ 3 A, 30 VDC= 3 A resistive load)
- Socket plug-in type (8-pin)
- N.O. or N.C. relay output available

Specifications

Model	PA-12	PA-12-PG	PA-12-PGP
Type	NPN / PNP switching	NPN open collector	PNP open collector
Power supply	110 / 220 VAC~ switching 50 / 60 Hz	110 / 220 VAC~ 50 / 60 Hz	
Power consumption	≈ 4 VA		
Sensor supply power ⁰¹⁾	12 VDC= ± 10 % 50 mA	12 VDC= ± 10 % 30 mA	
Control output	Relay contact output ⁰²⁾ Contact capacity: 250 VAC~ 3 A, 30 VDC= 3 A resistive load, Contact configuration: 1 a 1 b	NPN open collector output	PNP open collector output
NPN input signal	Short-circuit impedance : ≤ 1 kΩ Residual voltage : ≤ 2 VDC= Open-circuit impedance : ≥ 100 kΩ	Short-circuit impedance : ≤ 1 kΩ Residual voltage : ≤ 2 VDC= Open-circuit impedance: ≥ 100 kΩ	-
PNP input signal	High: 7 - 12 VDC= Low: 0 - 5 VDC=	-	High: 7 - 12 VDC= Low: 0 - 5 VDC=
Input resistance	10 kΩ	-	-
Response time	Input: ≥ 0.2 ms, Output: ≥ 10 ms		
Ambient temperature	-10 to 50 °C (no freezing or condensation)		
Ambient humidity	35 to 85 %RH (no freezing or condensation)		
Approval	EAC		
Unit weight	≈ 269 g		

01) Make sure that total consumption current shall not exceed sensor's power supply capacity when connecting a sensor.
02) Electrical life cycle: ≥ 10,000,000 operations, Mechanical life cycle: ≥ 100,000 operations





E5. Recorders

Recorders are devices which display and record various measured inputs including temperature, humidity, flux, and pressure.

E5-1	Paperless	KRN1000 Series	LCD Touchscreen Paperless Recorders
E5-2	Paper	KRN100 Series	100 mm Hybrid Recorders
		KRN50 Series	50 mm Hybrid Recorders

LCD Touchscreen Paperless Recorders

KRN1000 Series



Features

- 5.6-inch color TFT LCD (640 × 480) touchscreen display with excellent readability and intuitive control interface
- Supports maximum 16 input channel and 27 input types
- Various communication methods (default option: RS422 / 485, Ethernet, USB)
- 25 to 250 ms high-speed sampling, 1 to 3600 sec recording cycle
- 200 MB internal memory and external SD / USB memory (up to 32 GB) support
- Store and backup internal data to external SD / USB memory
- 9 different graph types available
- 4 types of option input / output available:
- digital input (non-contact / contact), alarm output, power output for transmitter
- Compact, space-saving design (depth: 69.2 mm)

Specifications

Series	KRN1000
Screen size	5.6 inch
LCD type	TFT Color LCD
Resolution	640 × 480 pixel
Brightness adjustment	3-level (Min. / Standard / Max.)
Touch	Resistive type
No of input channel	4 / 8 / 12 / 16 CH model
Universal input	Refer to Autonics website
Sampling cycle ⁰¹⁾	1 to 4 CH: 25 ms / 125 ms / 250 ms, 5 to 16 CH: 125 ms / 250 ms
Recording cycle	1 to 3,600 sec
Internal memory	≈ 200 MB
External memory ⁰²⁾	SD / USB memory maximum 32 GB
Power supply	100-240 VAC ~ 50 / 60 Hz
Allowable voltage range	85 to 110 % of rated power supply
Power consumption	≤ 23 VA
Dielectric strength	2,300 VAC ~ 50 / 60 Hz for 1 minute (between power terminals and case) (except Ethernet and USB device)
Vibration	10 to 60 Hz 4.9 m / s ² X, Y, Z in each X, Y, Z direction for 1 hour
Vibration (malfunction)	10 to 60 Hz 1 m / s ² X, Y, Z in each X, Y, Z direction for 10 minutes
Insulation resistance	≥ 20 MΩ (500 VDC ≡ megger)
Noise immunity	Square shaped noise by noise simulator (pulse width 1 μs) ± 2 kV
Time accuracy	Within ± 2 min / year (available up to 2099 year)
Protection structure	IP50 (front part, IEC standard)
Ambient temperature	0 to 50 °C, storage: -20 to 60 °C (no freezing or condensation)
Ambient humidity	35 to 85 %RH, storage: 35 to 85 %RH (no freezing or condensation)
Approval	CE EAC
Unit weight (packaged)	≈ 590 to 700 g (≈ 1,290 to 1,400 g)

01) Internal sampling cycle is average movement filter and alarm output operation unit time.

02) USB memory is included in the box. If you use USB memory you purchased separately, it could not be recognized.

100 mm Hybrid Recorders

KRN100 Series



Features

- 100 mm paper recorder
- Enables to record data without paper with the data logger function (internal memory and external memory supported to backup data)
- High speed sampling of 25 to 250 ms and high speed record of 240 mm / H in high speed graph mode
- 6 recording colors
- Easy parameter setting by quick menu setting
- Enables to set parameters and monitor with USB, RS485, Ethernet communication
- High legibility and setting convenient by graph LCD
- Supports up to 12 channels with slot type input cards
- Supports total 27 kinds of input types (weight, voltage, current, frequency potentiometer, and etc.)
- Installation space saving with compact design (depth: 168 mm)

Specifications

Series	KRN100
LCD type	STN Graphic LCD
Resolution	320 × 120 pixel
Brightness adjustment	4-level (OFF / Min / Standard / Max)
Backlight	White LED, 2-level (Temp / Always)
No of input channel	2 / 4 / 6 / 8 / 10 / 12 CH model (2 CH / universal input card)
Universal input	Refer to Autonics website
Sampling cycle ⁰¹⁾	1 to 4 CH: 25 ms / 125 ms / 250 ms, 5 to 12 CH: 125 ms / 250 ms (thermocouple (TC) - R, U, S, T: ≥ 50 ms)
Graph mode recording speed	10, 20, 40, 60, 120, 240 mm / H
Recording speed accuracy	F.S. ± 0.5 %
Saving cycle	1 to 3600 sec (inner log file is saved at 1 sec interval)
Internal memory	512 MB
External memory ⁰²⁾	USB memory max. 32 GB
Recording paper	113 mm × 9 m
Ink cartridge	Normal printing is available after going and returning printing maximum 5 times within 7 days after opening the unit
Ink dry time	≤ 15 minutes
Power supply	100-240 VAC ~ 50 / 60 Hz
Allowable voltage range	85 to 110 % of rated power supply
Power consumption	≤ 23 VA
Dielectric strength	Between power terminals and case: 2500 VAC ~ 50 / 60 Hz for 1 minute (except Ethernet and USB device)
Vibration (conveying and storing)	10 to 60 Hz 4.9 m / s ² X, Y, Z in each X, Y, Z direction for 1 hour
Vibration (operating)	10 to 60 Hz 1 m / s ² X, Y, Z in each X, Y, Z direction for 10 minutes
Insulation resistance	≥ 20 MΩ (500 VDC = megger)
Noise immunity	± 2 kV square wave noise (pulse width 1 μs) by noise simulator
Time accuracy	Within ± 2 min / year (available up to 2100 year)
Protection structure	IP50 (front part, IEC standard)
Ambient temperature	0 to 50 °C, storage: -20 to 60 °C (without the ink cartridge, no freezing or condensation)
Ambient humidity	35 to 85 %RH, storage: 35 to 85 %RH (no freezing or condensation)
Approval	CE ENEC
Unit weight (packaged)	≈ 1.7 to 2.0 kg (≈ 2.4 to 2.7 kg)

01) Internal sampling cycle is average movement filter and alarm output operation unit time.

02) USB memory is included in the box. If you use USB memory you purchased separately, it could not be recognized.

50 mm Hybrid Recorders

KRN50 Series



Features

- 50mm thermal transfer method of paper recorder
- Enables to record data without paper with the data logger function
- Support two recording modes: graph mode, digital mode
- Simultaneous recording of two channels
- Enables to set parameters and monitor with RS485 communication and dedicated communication port
- Multi-input with high accuracy 0.2 % level (RTD, TC, Voltage, Current (shunt))
- Supports various option I/O function
- Small size (W 96 × H 96 × L 100mm), light weight

Specifications

Series	KRN50	
LCD type	LCD dot matrix display	
Resolution	128 × 32 pixel	
No of input channel	1 / 2 CH model	
Input type	Refer to Autonics website	
Alarm output	CH1 (AL1, AL2), CH2 (AL1, AL2) relay output	
Alarm output adjustment sensitivity	Alarm output ON/OFF interval setting: 1 to 999 digit variable	
Communication output	RS485 communication output (Modbus RTU protocol method)	
Setting method	Setting with front key	
Sampling cycle	500 ms/CH (2 CH = 1,000 ms)	
Recording accuracy	± 0.5 % F.S.	
Graph mode recording speed	10, 30, 60, 120, 240, 480, 960 mm/H	
Graph mode memo speed	30 s, 1 min, 5 min, 10 min, 15 min, 30 min, 1 hour, 2 hour, 3 hour, 4 hour, 8 hour, 16 hour, 24 hour	
TEXT mode recording speed	00m 05s to 99m 59s	
Recording paper	Thermal Direct Receipt Paper (57 mm × 16 m)	
Recording paper supply method	Clamshell type	
Print method	Direct thermal line print	
Print resolution	80 dot/mm	
No. of print dot	384 dot/Line	
Print life cycle	50 km	
Language	Korean, English	
Input	AC voltage type	DC voltage type
Power supply	100-240 VAC~ 50/60 Hz	24 VDC=
Allowable voltage range	85 to 110 % of power supply	90 to 110 % of power supply
Power consumption	≤ 34 VA	≤ 79 W
Dielectric strength	2300 VAC~ 50/60 Hz for 1 minute (charging terminal of the different polarity)	
Vibration	0.75 mm amplitude at frequency of 10 to 55 Hz (for 1 min) in each of X, Y, Z directions for 1 hour	
Insulation resistance	≥ 100 MΩ (500 VDC= megger)	
Noise immunity	Square shaped noise by noise simulator (pulse width 1 μs) ±2 kV	
Ambient temperature	0 to 50 °C, storage: -20 to 60 °C (no freezing or condensation)	
Ambient humidity	35 to 85 %RH, storage: 35 to 85 %RH (no freezing or condensation)	
Approval	CE ENEC	
Unit weight	≈ 700 g	



E6. HMIs

HMIs provide users with an interface to directly interact with machines in order to control and monitor various processes.

E6-1	Logic Panels	LP-A Series	Color LCD Logic Panels
E6-2	Graphic Panels	GP-A Series	Color LCD Graphic Panels

Color LCD

Logic Panels

LP-A Series



Features

- Equipped with TFT LCD for realizing True color
- Easier system configuration and use with PLC, HMI, I/O all-in-one design
- Horizontal / Vertical installation according to environment
- Available to monitor device of the connected controllers even without user screen data
- Using user screen drawing program 'atDesigner'
 - : More variety functions, objects and library image
 - : Intuitive user interface
 - : Multilingual table function: switching language of user screen by touching a button
- Various communication interface: RS232C, RS422, Ethernet, CAN

Specifications

Model	LP-A070-T9D □ -C5 □	LP-A104-T9D □ -C6 □
Screen size	7.0 inch	10.4 inch
LCD type	TFT Color LCD	
Resolution	800×480 pixel	800×600 pixel
Display area	154.4×93.44 mm	211.2×158.4 mm
Display color	16,777,216 color	
LCD view angle (top/bottom/left/right)	Within 50°/60°/65°/65° of each	Within 60°/70°/80°/70° of each
Backlight	White LED	
Luminance adjustment	Adjustable by software	
Touch	Resistive type (4-wire)	
Input	16-point	32-point
Insulation method	Photo coupler insulation	
Rated input voltage	24 VDC=	
Rated input current	X0 to X8: ≈ 10 mA, X9 to XF: ≈ 4 mA	X0 to X8: ≈ 10 mA, X9 to X1F: ≈ 4 mA
Voltage range	19.2-28.8 VDC=	
Input resistance	X0 to X8: 3.3 kΩ, X9 to XF: 5.6 kΩ	X0 to X8: 3.3 kΩ, X9 to X1F: 5.6 kΩ
Response time	0.5 ms	
Common method	16-point/1COM	16-point/1COM, 16-point/1COM
Applicable wire	Stranded wire 0.3 to 0.7 mm ²	
Output	16-point	32-point
Power supply	24 VDC=	
Insulation method	Photo coupler insulation	
Rated load voltage	24 VDC=	
Load voltage range	19.2-28.8 VDC=	
Max. load current	0.1 A/1-point, 1.6 A/1COM	
Max. voltage falling when ON	≤ 0.2 VDC=	
Common method	16-point/1COM	16-point/1COM, 16-point/1COM
Applicable wire	Stranded wire 0.3 to 0.7 mm ²	
Approval	CE ENEC	
Unit weight (package)	≈ 540 g (= 742 g)	≈ 1.10 kg (= 1.66 kg)
Command	Basic command: 28, application command: 236	
Program capacity	8 K step	
Processing speed	Average: approx. 1μs/basic command, application command	
I/O control method	Batch processing	
Computer control method	Repeated-doubling method, interrupt processing	
Device range	Refer to 'LP-A Series user manual'	
Special function	Positioning function, motion controller, high speed counter	

Serial interface	RS232C, RS422
USB interface	USB Host, USB Device (USB2.0)
Ethernet interface	IEEE802.3(U), 10/100Base-T
CAN interface	24V CAN transceiver
External storage	Micro SD up to 32 GB (FAT16/32)
Real-time controller	RTC embedded
Battery life cycle	3 years at 25°C

Supportive interface can be different up to model. Please refer to 'Ordering Information' for the supportive interface per model and 'LP-A Series user manual' and 'GP/LP user manual for communication' for the detailed information about each interface.

Language	Korean, English
Text	Bitmap and vector font
Memory for user screen	64 MB
Number of user screen	100 pages
Power supply	24 VDC≐
Allowable voltage range	90 to 110% of power supply
Power consumption	7.0 inch : ≤ 7.2 W, 10.4 inch : ≤ 8.0 W
Insulated resistance	≥ 100 MΩ (500 VDC≐ megger) (between all terminals and case)
Ground	3rd grounding (≤ 100 Ω)
Noise immunity	The square wave noise (pulse width: 1 μs) by the noise simulator ± 0.5 kV
Dielectric strength	500 VAC~ 50/60 Hz for 1 minute (between all terminals and case)
Vibration	0.75 double amplitude at frequency of 10 to 55 Hz in each X, Y, Z direction for 1 hour
Vibration (malfunction)	0.5 double amplitude at frequency of 10 to 55 Hz in each X, Y, Z direction for 10 minutes
Shock	147 m/s ² (approx. 15 G) in each X, Y, Z direction for 3 times
Shock (malfunction)	100 m/s ² (approx. 10 G) in each X, Y, Z direction for 3 times
Ambient temperature	0 to 50 °C, storage: -20 to 60 °C (no freezing or condensation)
Ambient humidity	35 to 85%RH, storage : 35 to 85%RH (no freezing or condensation)
Protection structure	IP65 (front panel, IEC standard)

Software

Visit Autonics web site to download software.

[atDesigner]

atDesigner is for editing project file.

[atLogic]

atLogic is for writing and debugging program.

[Recommended computer specification]

Item	Recommended spec for atDesigner	Recommended spec for atLogic
Operating system	Microsoft Windows 7/8.1/10	Microsoft Windows 7/8.1/10
CPU	Over Intel Core i5-2nd gen. 2500	Over Pentium Dual Core
Memory	Over 8 GB	Over 1 GB
Hard disk	Over 8 GB free space	Over 5 GB free space
Resolution	1920×1080	1280×1024

[Firmware]

Please refer to 'LP-A Series user manual' for firmware upgrade.

Color LCD

Graphic Panels

GP-A Series



Features

- Equipped with TFT LCD for realizing True color
- Horizontal / Vertical installation according to environment
- Available to monitor device of the connected controllers even without user screen data
- Using user screen drawing program 'atDesigner'
 - : More variety functions, objects and library image
 - : Intuitive user interface
 - : Multilingual table function: switching language of user screen by touching a button
- Various communication interface: RS232C, RS422, Ethernet, CAN

Specifications

Model	GP-A046	GP-A057	GP-A070	GP-A104
Screen size	4.6 inch	5.7 inch	7.0 inch	10.4 inch
LCD type	TFT Color LCD			
Resolution	800×320 pixel	640×480 pixel	800×480 pixel	800×600 pixel
Display area	108×43.2 mm	115.2×86.4 mm	154.4×93.44 mm	211.2×158.4 mm
Display color	16,777,216 color	262,144 color	16,777,216 color	16,777,216 color
LCD view angle (top/bottom/left/right)	Within 75°/70°/80°/80° of each	Within 70°/70°/80°/80° of each	Within 50°/60°/65°/65° of each	Within 60°/70°/80°/70° of each
Backlight	White LED			
Luminance adjustment	Adjustable by software			
Touch	Resistive type (4-wire)			
Approval	CE ENEC			
Unit weight (packaged)	≈ 272 g (≈ 382 g)	≈ 489 g (≈ 644 g)	≈ 520 g (≈ 706 g)	≈ 1.07 kg (≈ 1.62 kg)
Serial interface	RS232C, RS422			
USB interface	USB Host, USB Device(USB2.0)			
Ethernet interface	IEEE802.3(U), 10/100Base-T			
CAN interface	24V CAN transceiver			
External storage	Micro SD up to 32GB (FAT16/32)			
Real-time controller	RTC embedded			
Battery life cycle	3 years at 25°C			
Supportive interface can be different up to model. For the detailed information, please refer to 'Ordering Information'.				
Language	Korean, English			
Text	Bitmap and vector font			
Memory for user screen	64MB			
Number of user screen	100 pages			
Power supply	24 VDC≡			
Allowable voltage range	90 to 110% of power supply			
Power consumption	4.6 inch : ≤ 4.8 W, 5.7 / 7.0 inch : ≤ 7.2 W, 10.4 inch : ≤ 8.0 W			
Insulated resistance	≥ 100 MΩ (500 VDC≡ megger) (between all terminals and case)			
Ground	3rd grounding (≤ 100 Ω)			
Noise immunity	The square wave noise (pulse width: 1μs) by the noise simulator ± 0.5 kV			
Dielectric strength	500 VAC~ 50/60 Hz for 1 minute (between all terminals and case)			
Vibration	0.75 double amplitude at frequency of 10 to 55 Hz in each X, Y, Z direction for 1 hour			
Vibration (malfunction)	0.5 double amplitude at frequency of 10 to 55 Hz in each X, Y, Z direction for 10 minutes			
Shock	147 m/s ² (approx. 15 G) in each X, Y, Z direction for 3 times			
Shock (malfunction)	100 m/s ² (approx. 10 G) in each X, Y, Z direction for 3 times			
Ambient temperature	0 to 50°C, storage: -20 to 60°C (a non freezing or condensation environment)			
Ambient humidity	35 to 85%RH, storage: 35 to 85%RH (a non freezing or condensation environment)			
Protection structure	IP65 (front panel, IEC standard)			

Software

Visit Autonics web site to download software.

[atDesigner]

atDesigner is for editing project file.

Recommended computer specification for atDesigner is as below.

Item	Recommended spec
Operating system	Windows 7/10
CPU	Intel Core i5-2nd gen. 2500
Memory	8GB
Hard disk	8GB free space
Resolution	1920×1080

[Firmware]

Please refer to 'GP-A Series user manual' for firmware upgrade.



E7. Counters

Counters, widely used in manufacturing lines and automation systems, display and control received pulse signals from input devices.

E7-1	Counters / Timers	CX Series	LCD Counters / Timers
		CT Series	Programmable Digital Counters / Timers
		FXS Series	Digital Counters / Timers
		FXM / FXH Series	Digital Counters / Timers
		FXY Series	Digital Counters / Timers (Indicator)
E7-2	Counters (Indicator Only)	LA8N Series	LCD Digital Counters (Indicator)
E7-3	8-Pin Plug	FS Series	8-Pin Plug Digital Counters
E7-4	Measure	FM Series	Digital Measure Counters

LCD

Counters / Timers

CX Series



Features

- LCD display with easy-to-read white PV characters
- Input type: voltage input (PNP) / no-voltage input (NPN) selectable (through parameter setting), universal voltage input type available
- One-shot output time: 0.01 to 99.99 seconds (in 0.01 second increments)
- Compact rear-length size (64.5 mm)

[Counter]

- Prescale value setting range: 0.00001 to 99999.9
- Various input / output modes (11 input modes, 11 output modes)
- Set start point function
- Total count display mode: displays current count and aggregate count simultaneously

[Timer]

- Various output modes (15 output modes)
- Time setting range: 0.001 second to 99999.9 hours
- Set output time to 0 feature

Specifications

Model	CX6S-1P□□	CX6S-2P□□	CX6M-1P□□	CX6M-2P□□
Display digits	6-digit			
Display method	7-segment (1st, 2nd digits of counting value display: white, setting value display: green), 11-segment (the other digits of counting value display: white) LCD			
Character size	W × H (unit: mm)			
Counting value	4.1 × 10.1		6.2 × 15.2	
Setting value	3.3 × 8.1		5 × 12.3	
Counter	Count up, count down, count up / down			
Counting range ⁰¹⁾	-99999 to 999999			
Timer	Count up, count down			
Repeat / SET / voltage / Temp. Error	CX6 - □ P : Power ON Start: ≤ ± 0.01 % ± 0.05 sec Signal ON Start: ≤ ± 0.01 % ± 0.03 sec CX6 - □ P F: Power ON Start: ≤ ± 0.01 % ± 0.08 sec Signal ON Start: ≤ ± 0.01 % ± 0.06 sec			
Input logic (CX6□-□P□□)	Voltage input (PNP) - input impedance: 10.8 kΩ, [H]: 5 - 30 VDC≡, [L]: 0 - 2 VDC≡ No-voltage input (NPN) - short-circuit impedance: ≤ 1 kΩ, short-circuit residual voltage: ≤ 2 VDC≡			
Input logic (CX6□-□P□F)	Free voltage input - INA (START), INB (INHIBIT) input, [H]: 24 - 240 VAC~ 50 / 60 Hz / 24 - 240 VDC≡ [L]: 0 - 10 VAC~ / VDC≡ No-voltage input - RESET input, short-circuit impedance: ≤ 1 kΩ, short-circuit residual voltage: ≤ 2 VDC≡			
One-shot output time	0.01 to 99.99 s			
Unit weight (packaged)	Dependent on the model			
CX6□-□P4	≈ 112 g (≈ 157 g)	≈ 117 g (≈ 162 g)	≈ 170 g (≈ 235 g)	≈ 175 g (≈ 240 g)
CX6□-□P4F	≈ 110 g (≈ 155 g)	≈ 115 g (≈ 160 g)	≈ 168 g (≈ 233 g)	≈ 173 g (≈ 238 g)
CX6□-□P2	≈ 111 g (≈ 156 g)	≈ 116 g (≈ 161 g)	≈ 169 g (≈ 234 g)	≈ 174 g (≈ 239 g)
CX6□-□P2F	≈ 109 g (≈ 154 g)	≈ 114 g (≈ 159 g)	≈ 167 g (≈ 232 g)	≈ 172 g (≈ 237 g)
Approval	CE ENEC			

01) It varies depending on the setting of decimal points.

Model	CX6S-□P□□	CX6M-□P□□
Contact control output	Relay	
Type (1-stage)	SPDT (1c) × 1	SPDT (1c) × 1
Type (2-stage)	SPST (1a) × 2	SPDT (1c) × 2
Capacity	≤ 250 VAC~ 3 A, ≤ 30 VDC≡ 3 A resistive load	≤ 250 VAC~ 3 A, ≤ 30 VDC≡ 3 A resistive load
Solid-state control output	-	
Type (1-stage)	-	
Type (2-stage)	-	
Capacity	-	
		≤ 30 VDC≡, 100 mA

Voltage	AC voltage type	AC / DC voltage type
Power supply	100 - 240 VAC~ ± 10 % 50 / 60 Hz	24 VAC~ ± 10 % 50 / 60 Hz, 24 - 48 VDC= ± 10 %
Power consumption	Dependent on the model	
CX6S-1P□	≤ 6.4 VA	AC: ≤ 5.5 VA, DC: ≤ 3.5 W
CX6S-1P□F	≤ 4.2 VA	AC: ≤ 3.6 VA, DC: ≤ 2.5 W
CX6S-2P□	≤ 6.7 VA	AC: ≤ 5.6 VA, DC: ≤ 3.6 W
CX6S-2P□F	≤ 4.9 VA	AC: ≤ 4.0 VA, DC: ≤ 2.8 W
CX6M-1P□	≤ 7.1 VA	AC: ≤ 6.2 VA, DC: ≤ 4 W
CX6M-1P□F	≤ 4.7 VA	AC: ≤ 3.9 VA, DC: ≤ 2.9 W
CX6M-2P□	≤ 7.5 VA	AC: ≤ 6.3 VA, DC: ≤ 4.1 W
CX6M-2P□F	≤ 5.4 VA	AC: ≤ 4.5 VA, DC: ≤ 3.3 W
External power supply ⁰¹⁾	≤ 12 VDC= ± 10 % 100 mA	
Memory retention	≈ 10 years (non-volatile semiconductor memory type)	
Insulation resistance	≥ 100 MΩ (500 VDC= megger)	
Dielectric strength	3,000 VAC~ 50 / 60 Hz for 1 minute	
Noise immunity	± 2 kV square wave noise (pulse width: 1 μs) by the noise simulator	± 500 V square wave noise (pulse width: 1 μs) by the noise simulator
Vibration	0.75 mm double amplitude at frequency of 10 to 55Hz (for 1 minute) in each X, Y, Z direction for 1 hour	
Vibration (malfunction)	0.5 mm double amplitude at frequency of 10 to 55Hz (for 1 minute) in each X, Y, Z direction for 10 minute	
Shock	300 m/s ² (≈ 30 G) in each X, Y, Z direction for 3 times	
Shock (malfunction)	100 m/s ² (≈ 10 G) in each X, Y, Z direction for 3 times	
Relay life cycle	Mechanical: ≥ 5,000,000 operations Electrical: ≥ 100,000 operations	
Ambient temp.	-10 to 55 °C, storage: -25 to 65 °C (no freezing or condensation)	
Ambient humi.	35 to 85 %RH, storage: 35 to 85 %RH (no freezing or condensation)	
Protection rating	IP65 (front part, IEC standard)	

01) This is for the CX6□-□P□ model.

Programmable Digital Counters / Timers

CT Series



Features

- Communication function supported
(communication model): RS485 (Modbus RTU)

- One-shot output time setting range:
0.01 sec to 99.99 sec by setting per 10ms

[Counter]

- Prescale value setting range: 6-digit model:
0.00001 to 99999.9 / 4-digit model:
0.001 to 999.9

- Various input / output modes
(9 input / 11 output modes)

- BATCH counter, count Start Point
(counting initial value) setting function

[Timer]

- Various output modes (13 modes)

- Various time setting range:
6-digit model: 0.001 sec to 99999.9 hour /
4-digit model: 0.001 sec to 9999 hour

- '0' time setting function

- Selectable timer memory retention
function for indicator model.

Specifications

Model	CTS□-□□□	CTY□-□□□	CTM□-□□□
Display digits	4-digit	6-digit	6-digit
Display method	7-segment (counting value: red, setting value: green) LED		
Character size	W × H (unit: mm)		
Counting value	6.5 × 10	4.5 × 10	4.2 × 9.5
Setting value	4.5 × 8	3.5 × 7	3.5 × 7
Counter	Count up, count down, count up / down		
Counting range ⁰¹⁾	-999 to 9999 -99999 to 999999		
Timer	Count up, count down		
Error	Repeat / SET / voltage / Temp. - Power ON Start: ≤ ± 0.01 % ± 0.05 sec Signal ON Start: ≤ ± 0.01 % ± 0.03 sec		
Input logic	Voltage input (PNP) - input impedance: 5.4 kΩ, [H]: 5 - 30 VDC≒, [L]: 0 - 2 VDC≒ No-voltage input (NPN) - short-circuit impedance: ≤ 1 kΩ, short-circuit residual voltage: ≤ 2 VDC≒		
One-shot output time	0.01 to 99.99 s		
Product components	Product, instruction manual		
Bracket	Mounted	× 2	× 2
Unit weight (packaged)	≈ 159 g (≈ 212 g)	≈ 140 g (≈ 228 g)	≈ 252 g (≈ 322 g)
Approval	CE cULus ENEC		

01) It varies depending on the setting of decimal points.

Model	CTS□-□□□	CTY□-□□□	CTM□-□□□
Contact control output	Relay		
Type (1-stage)	SPDT (1c) × 1	SPDT (1c) × 1	SPDT (1c) × 1
Type (2-stage)	SPST (1a) × 2	Standard: SPST (1a) × 1, SPDT (1c) × 1 Communication: SPST (1a) × 2	SPST (1a) × 1, SPDT (1c) × 1
Capacity	250 VAC~ 5 A, 30 VDC≒ 5 A resistive load	250 VAC~ 3 A, 30 VDC≒ 3 A resistive load	250 VAC~ 5 A, 30 VDC≒ 5 A resistive load
Solid-state control output	NPN open collector		
Type (1-stage)	Standard: × 1, Communication: -	Standard: × 1, Communication: × 1	Standard: × 2, Communication: × 2
Type (2-stage)	Standard: × 1, Communication: -	Standard: × 1, Communication: -	Standard: × 3, Communication: × 2
Capacity	≤ 30 VDCT, 100 mA	≤ 30 VDC≒, 100 mA	≤ 30 VDC≒, 100 mA

Voltage	AC voltage type	AC / DC voltage type
Power supply	100 - 240 VAC~ ± 10 % 50 / 60 Hz	24 VAC~ ± 10 % 50 / 60 Hz, 24 - 48 VDC± ± 10 %
Power consumption	≤ 12 VA	AC: ≤ 10 VA, DC: ≤ 8 W
External power supply	≤ 12 VDC± ± 10 % 100 mA	
Memory retention	≈ 10 years (non-volatile semiconductor memory type)	
Insulation resistance	≥ 100 MΩ (500 VDC± megger)	
Dielectric strength	2,000 VAC~ 50 / 60 Hz for 1 minute	
Noise immunity	± 2 kV square wave noise (pulse width: 1 μs) by the noise simulator	± 500 V square wave noise (pulse width: 1 μs) by the noise simulator
Vibration	0.75 mm double amplitude at frequency of 10 to 55 Hz (for 1 minute) in each X, Y, Z direction for 1 hour	
Vibration (malfunction)	0.5 mm double amplitude at frequency of 10 to 55 Hz (for 1 minute) in each X, Y, Z direction for 10 min	
Shock	300 m/s ² (≈ 30 G) in each X, Y, Z direction for 3 times	
Shock (malfunction)	100 m/s ² (≈ 10 G) in each X, Y, Z direction for 3 times	
Relay life cycle	Mechanical: ≥ 1,000,000 operations, Electrical: ≥ 100,000 operations	
Ambient temperature	-10 to 55 °C, storage: -25 to 65 °C (no freezing or condensation)	
Ambient humidity	35 to 85 %RH, storage: 35 to 85 %RH (no freezing or condensation)	
Protection rating	IP65 (front part, IEC standard)	
Comm. protocol	Modbus RTU (16-bit CRC)	

Digital Counters / Timers

FXS Series



Features

- Counting speed: 1 cps / 30 cps / 2 kcps / 5 kcps
- Selectable voltage input (PNP) or no-voltage input (NPN)
- Input mode: Up, Down, Up / Down
- Dot for Decimal Point, Hour / Min / Second by RESET key
- Wide range of input power supply : 100 - 240 VAC~ 50 / 60 Hz, 24 VAC~ 50 / 60 Hz, 24 - 48 VDC= universal
- Selectable Counter / Timer by DIP switch

[Counter]

- 20 input modes / 18 output modes

[Timer]

- 16 output modes
- Various time setting range
 - 5-digit model: 0.01 sec to 9999.9 hour
 - 4-digit model: 0.01 sec to 9999 hour
- Output: indicator, 1-stage setting

Specifications

Model	FX4S-1P□	FX5S-1□
Display digits	4-digit	5-digit
Character size	W 3.8 × H 7.6 mm	W 4 × H 8 mm
Max. counting speed	1 / 30 / 2 k / 5 kcps	
Return time	≤ 500 ms	
Min. signal width	INHIBIT, RESET: ≈ 20 ms	
Input logic	Voltage input (PNP) - input impedance: ≤ 10.8 kΩ, [H]: 5 - 30 VDC=, [L]: 0 - 2 VDC= No-voltage input (NPN) - short-circuit impedance: ≤ 470 Ω, short-circuit residual voltage: ≤ 1 VDC= open-circuit impedance: ≥ 100 kΩ	
One-shot output time	0.05 to 5 sec	
Error	Repeat / SET / voltage / Temp.: ≤ ± 0.01 % ± 0.05 s	
Contact control output	Relay	-
Type	Instantaneous SPDT (1c) × 1	-
Capacity	250 VAC~ 3 A, 30 VDC= 3 A resistive load	-
Solid-state control output	NPN open collector × 1	-
Capacity	≤ 30 VDC=, 100 mA	-
Unit weight (packaged)	≈ 110 g (≈ 171 g)	≈ 95 g (≈ 156 g)
Approval	CE	
Voltage type	AC voltage	AC / DC voltage
Power supply	100 - 240 VAC~ ± 10 % 50 / 60 Hz	24 VAC~ ± 10 % 50 / 60 Hz, 24 - 48 VDC± 10 %
Power consumption (FX4S-1P)	≤ 4.6 VA	AC: ≤ 3.5 VA DC: ≤ 2.3 W
Power consumption (FX5S-1)	≤ 3.8 VA	AC: ≤ 3 VA DC: ≤ 1.8 W
External supply power	≤ 12 VDC= ± 10 % 50 mA	
Memory retention	≈ 10 years (non-volatile semiconductor memory type)	
Insulation resistance	≥ 100 MΩ (500 VDC= megger)	
Dielectric strength	Between all terminals and case: 2,000 VAC~ 50 / 60 Hz for 1 minute	
Noise immunity	± 2 kV square wave noise (pulse width: 1 μs) by the noise simulator	± 500 V square wave noise (pulse width: 1 μs) by the noise simulator
Vibration	0.75 mm double amplitude at frequency of 10 to 55 Hz (for 1 minute) in each X, Y, Z direction for 1 hour	
Vibration (malfunction)	0.5 mm double amplitude at frequency of 10 to 55 Hz (for 1 minute) in each X, Y, Z direction for 10 min	
Shock	300 m/s ² (≈ 30 G) in each X, Y, Z direction for 3 times	
Shock (malfunction)	100 m/s ² (≈ 10 G) in each X, Y, Z direction for 3 times	
Relay life cycle	Mechanical: ≥ 5,000,000 operations Electrical: ≥ 100,000 operations (250 VAC~ 3 A resistive load)	
Ambient temperature	-10 to 55 °C, storage: -25 to 65 °C (no freezing or condensation)	
Ambient humidity	35 to 85 %RH, storage: 35 to 85 %RH (no freezing or condensation)	
Protection rating	IP20 (front part, IEC standard)	

Digital Counters / Timers

FXM / FXH Series



Features

- Counting speeds: 1 cps / 30 cps / 2 kcps / 5kcps
- Switch between counter and timer operation using DIP switch
- No-voltage input (NPN) using DIP switch
- Operation modes: count-up, count-down, count-up / down
- Set decimal point, hr / min / sec display with RESET key

[Counter]

- 20 input modes, 18 output modes

[Timer]

- Various output modes (16 output modes)
- Various time setting ranges:
 - 8-digit models: 0.01 sec to 99999 hr 59.9 min
 - 6-digit models: 0.1 sec to 99999.9 hr
 - 4-digit models: 0.01 sec to 9999 hr
- Output model types: single preset, dual preset, indicator only
- Power supply: 100 - 240 VAC ~ 50 / 60 Hz

Specifications

Model	FX4□-□4	FX6M-□4	FX8M-□4
Display digits	4-digit	6-digit	8-digit
Character size	W 6 × H 10 mm	W 4 × H 8 mm	W 3.8 × H 7.6 mm
Max. counting speed	1 / 30 / 2 k / 5 k cps		
Return time	≤ 500 ms		
Min. signal width	INHIBIT, RESET: ≈ 20 ms		
Input logic	Voltage input (PNP) - input impedance: ≤ 10.8 kΩ, [H]: 5 - 30 VDC≐, [L]: 0 - 2 VDC≐ No-voltage input (NPN) - short-circuit impedance: ≤ 470 Ω, short-circuit residual voltage: ≤ 1 VDC≐, open-circuit impedance: ≥ 100 kΩ		
One-shot output time	Dependent on the output		
1-stage setting	0.05 to 5 sec		
2-stage setting	OUT1: 0.5 sec fixed, OUT2: 0.05 to 5 sec		
Error	Repeat / SET / voltage / Temp.: ≤ ± 0.01 % ± 0.05 s		
Contact control output	Relay		
Type (1-stage)	Instantaneous SPDT (1c) × 1		
Type (2-stage)	Instantaneous SPDT (1c) × 2		
Capacity	250 VAC ~ 3 A, 30 VDC ≐ 3 A resistive load		
Solid-state control output	NPN open collector		
Type (1-stage)	× 1		
Type (2-stage)	× 2		
Capacity	≤ 30 VDC ≐, 100 mA, residual voltage: ≤ 1 VDC≐		
Unit weight (packaged)	1-stage setting: ≈ 180 g (≈ 245 g), 2-stage setting: ≈ 200 g (≈ 265 g), Indicator: ≈ 160 g (≈ 225 g)		
Approval	CE, RoHS, ENEC		
Power supply	100 - 240 VAC ~ ± 10 % 50 / 60 Hz		
Power consumption	Dependent on the output		
1-stage setting	≤ 4.6 VA		
2-stage setting	≤ 5.8 VA		
Indicator	≤ 3.8 VA		
External supply power	≤ 12 VDC ≐ ± 10 % 50 mA		
Memory retention	≈ 10 years (non-volatile semiconductor memory type)		
Insulation resistance	≥ 100 MΩ (500 VDC ≐ megger)		
Dielectric strength	Between all terminals and case: 2,000 VAC ~ 50 / 60 Hz for 1 min		
Noise immunity	± 2 kV square wave noise (pulse width: 1 μs) by the noise simulator		
Vibration	0.75 mm double amplitude at frequency of 10 to 55 Hz (for 1 minute) in each X, Y, Z direction for 1 hour		
Vibration (malfunction)	0.5 mm double amplitude at frequency of 10 to 55 Hz (for 1 minute) in each X, Y, Z direction for 10 minute		
Shock	300 m/s ² (≈ 30 G) in each X, Y, Z direction for 3 times		
Shock (malfunction)	100 m/s ² (≈ 10 G) in each X, Y, Z direction for 3 times		
Relay life cycle	Mechanical: ≥ 10,000,000 operations Electrical: ≥ 100,000 operations (250 VAC ~ 3 A resistive load)		
Ambient temperature	-10 to 55 °C, storage: -25 to 65 °C (no freezing or condensation)		
Ambient humidity	35 to 85 %RH, storage: 35 to 85 %RH (no freezing or condensation)		
Protection rating	IP20 (front part, IEC standard)		

Digital Counters / Timers (Indicator)

FX Y Series



Features

- Counting speeds: 1 cps / 30 cps / 2 kcps / 5 kcps
- Switch between counter and timer operation using DIP switch
- Switch between voltage input (PNP) and no-voltage input (NPN) using DIP switch
- Set decimal point, hr / min / sec display with RESET key
- Operation modes: count-up, count-down, count-up / down (counter)

[Counter]

- 20 input modes

[Timer]

- Various time setting ranges
 - 6-digit models: 0.01 sec to 99999.9 hr
 - 4-digit models: 0.01 sec to 9999 hr
- Power supply
 - 100 - 240 VAC~ 50 / 60 Hz (AC type)
 - 24 VAC~ 50 / 60 Hz,
 - 24 - 48 VDC= (AC / DC universal type)

Specifications

Model	FX4Y-□	FX6Y-□
Display digits	4-digit	6-digit
Character size	W 8 × H 14 mm	W 4 × H 8 mm
Max. counting speed	1 / 30 / 2 k / 5 k cps	
Return time	≤ 500 ms	
Min. signal width	INHIBIT, RESET: ≈ 20 ms	
Input logic	Voltage input (PNP) - input impedance: ≤ 10.8 kΩ, [H]: 5 - 30 VDC=, [L]: 0 - 2 VDC= No-voltage input (NPN) - short-circuit impedance: ≤ 470 Ω, short-circuit residual voltage: ≤ 1 VDC= open-circuit impedance: ≥ 100 kΩ	
Error	Repeat / SET / voltage / Temp.: ≤ ± 0.01 % ± 0.05 s	
Unit weight (packaged)	≈ 120 g (≈ 175 g)	
Approval	CE e 90018 ENEC	
Voltage type	AC voltage	AC / DC voltage
Power supply	100 - 240 VAC~ ± 10 % 50 / 60 Hz	24 VAC~ ± 10 % 50 / 60 Hz, 24 - 48 VDC= ± 10 %
Power consumption	≤ 3.8 VA	AC: ≤ 2.8 VA DC: ≤ 1.8 W
External supply power	≤ 12 VDC= ± 10 % 50 mA	
Memory retention	≈ 10 years (non-volatile semiconductor memory type)	
Insulation resistance	≥ 100 MΩ (500 VDC= megger)	
Dielectric strength	Between all terminals and case: 2,000 VAC~ 50 / 60 Hz for 1 min	
Noise immunity	± 2 kV square wave noise (pulse width: 1 μs) by the noise simulator	± 500 V square wave noise (pulse width: 1 μs) by the noise simulator
Vibration	0.75 mm double amplitude at frequency of 10 to 55 Hz (for 1 minute) in each X, Y, Z direction for 1 hour	
Vibration (malfunction)	0.5 mm double amplitude at frequency of 10 to 55 Hz (for 1 minute) in each X, Y, Z direction for 10 minute	
Shock	300 m/s ² (≈ 30 G) in each X, Y, Z direction for 3 times	
Shock (malfunction)	100 m/s ² (≈ 10 G) in each X, Y, Z direction for 3 times	
Ambient temperature	-10 to 55 °C, storage: -25 to 65 °C (no freezing or condensation)	
Ambient humidity	35 to 85 %RH, storage: 35 to 85 %RH (no freezing or condensation)	
Protection rating	IP40 (front part, IEC standard)	

LCD Digital Counters (Indicator)

LA8N Series



Features

- No additional power due to internal battery
- Signal input method: No-voltage input, voltage input, free voltage input
- Screw terminal type (attaching terminal cover)
- LCD display, backlight model
- IP66 protection structure

Specifications

Model	LA8N-BN	LA8N-BN-L	LA8N-BV	LA8N-BV-L	LA8N-BF
Display digits	8-digit				
Display method	LCD Zero Blanking (character size: W 3.4 × H 8.7 mm)				
Max. counting speed	1 cps, 30 cps, 1 kcps				20 cps
Operation method	Count up, count down, count up/down	Count up	Count up, count down, count up/down	Count up	Count up
Counting range	-9999999 to 99999999	0 to 99999999	-9999999 to 99999999	0 to 99999999	0 to 99999999
Input method	No-voltage input		Voltage input		Free voltage input
Counting input (H)	Short Residual voltage: ≤ 0.5 VDC≐ Max. impedance: ≤ 10 kΩ		4.5 - 30 VDC≐		24 - 240 VAC~ / 6 - 240 VDC≐
Counting input (L)	Open Min. impedance: ≥ 750 kΩ		0 - 2 VDC≐		0 - 2 VAC~ / 0 - 2.4 VDC≐
RESET input	No-voltage input		Voltage input		No-voltage input
Min. signal width (UP, DOWN)	≈ 20 ms	-	≈ 20 ms	-	-
Min. signal width (RESET)	≈ 20 ms				
Unit weight (packaged)	≈ 50 g (≈ 96 g)				
Approval	CE ENEC				
Power supply	Built-in battery (CR2477)				
Battery life cycle	≥ 7 years (at ≈ 20 °C)				
Backlight power	24 VDC≐ ± 10 %				
Insulation resistance	≥ 100 MΩ (500 VDC≐ megger)				
Dielectric strength ⁰¹⁾	2,000 VAC~ 60 Hz for 1 min				
Vibration	0.75 mm double amplitude at frequency of 10 to 55Hz (for 1 minute) in each X, Y, Z direction for 1 hour				
Vibration (malfunction)	0.3 mm double amplitude at frequency of 10 to 55Hz (for 1 minute) in each X, Y, Z direction for 10 minute				
Shock	300 m/s ² (≈ 30 G) in each X, Y, Z direction for 3 times				
Shock (malfunction)	100 m/s ² (≈ 10 G) in each X, Y, Z direction for 3 times				
Ambient temp.	-10 to 55 °C, storage: -25 to 65 °C (no freezing or condensation)				
Ambient humi.	35 to 85 %RH, storage: 35 to 85 %RH (no freezing or condensation)				
Protection rating	IP66 (front part, when using the rubber waterproof ring, IEC standard)				

01) No-voltage input, voltage input: between all terminals and case

Free voltage input: between free voltage input terminal and RESET input terminal, between all terminals and case

8-Pin Plug Digital Counters

FS Series



Features

- Counting speeds: 1 cps / 30 cps / 2 kcps / 5 kcps
- Switch between voltage input (PNP) and no-voltage input (NPN) using DIP switch
- Operation modes: count-up, count-down
- Decimal point display function (fixed decimal point)
- 10 year memory protection (using non-volatile semiconductor)
- Output model types: single preset, indicator only
- Power supply
 - 100 - 240 VAC \sim 50 / 60 Hz (AC type)
 - 24 VAC \sim 50 / 60 Hz,
 - 24 - 48 VDC \equiv (AC / DC universal type)

Specifications

Model	FS4-1P□	FS5-I4
Display digits	4-digit	5-digit
Character size	W 3.8 × H 7.6 mm	W 4 × H 8 mm
Max. counting speed	1 / 30 / 2 k / 5 k cps	
Return time	≤ 500 ms	
Min. signal width	RESET: ≈ 20 ms	
Input logic	Voltage input (PNP) - input impedance: ≤ 10.8 k Ω , [H]: 5 - 30 VDC \equiv , [L]: 0 - 2 VDC \equiv No-voltage input (NPN) - short-circuit impedance: ≤ 470 Ω , short-circuit residual voltage: ≤ 1 VDC \equiv , open-circuit impedance: ≥ 100 k Ω	
One-shot output time	0.05 to 5 sec	
Contact control output	Relay	-
Type	Instantaneous SPST (1a) × 1	-
Capacity	250 VAC \sim 3 A, 30 VDC \equiv 3 A resistive load	-
Unit weight (packaged)	≈ 90 g (≈ 130 g)	≈ 80 g (≈ 120 g)
Approval	CE  IEC	
Voltage type	AC voltage	AC / DC voltage
Power supply	100 - 240 VAC \sim ± 10 % 50 / 60 Hz	24 VAC \sim ± 10 % 50 / 60 Hz, 24 - 48 VDC \equiv ± 10 %
Power consumption (FS4-1P□)	≤ 4.6 VA	AC: ≤ 3.5 VA DC: ≤ 2.3 W
Power consumption (FS5-I4)	≤ 3.8 VA	-
External supply power	≤ 12 VDC \equiv ± 10 % 50 mA	
Memory retention	≈ 10 years (non-volatile semiconductor memory type)	
Insulation resistance	≥ 100 M Ω (500 VDC \equiv megger)	
Dielectric strength	Between all terminals and case: 2,000 VAC \sim 50 / 60 Hz for 1 minute	
Noise immunity	± 2 kV square wave noise (pulse width: 1 μ s) by the noise simulator	± 500 V square wave noise (pulse width: 1 μ s) by the noise simulator
Vibration	0.75 mm double amplitude at frequency of 10 to 55 Hz (for 1 minute) in each X, Y, Z direction for 1 hour	
Vibration (malfunction)	0.5 mm double amplitude at frequency of 10 to 55 Hz (for 1 minute) in each X, Y, Z direction for 10 min	
Shock	300 m/s ² (≈ 30 G) in each X, Y, Z direction for 3 times	
Shock (malfunction)	100 m/s ² (≈ 10 G) in each X, Y, Z direction for 3 times	
Relay life cycle	Mechanical: ≥ 5,000,000 operations Electrical: ≥ 100,000 operations (250 VAC \sim 3 A resistive load)	
Ambient temperature	-10 to 55 °C, storage: -25 to 65 °C (no freezing or condensation)	
Ambient humidity	35 to 85 %RH, storage: 35 to 85 %RH (no freezing or condensation)	
Protection rating	IP20 (front part, IEC standard)	

Digital Measure Counters

FM Series



Features

- Measure counting: multiply-mode / divide-mode
- Operation modes: count-up, count-down, count-up / down
- Counting speeds: 1 cps / 30 cps / 300 cps / 2 kcps / 5 kcps
- Parameter configuration settings: input / output operation mode, max. counting speed, decimal point location, OUT1 / OUT2 output time (0.01 to 99.99 sec), no-voltage (NPN) / voltage (PNP) input selection, multiply-mode / divide-mode selection
- 10 year memory protection (using non-volatile semiconductor)
- Power supply: 100 - 240 VAC ~ 50 / 60 Hz

Specifications

Model	FM4M-□4	FM6M-□4
Display digits	4-digit	6-digit
Character size	W 6 × H 10 mm	W 4 × H 8 mm
Max. counting speed	1 / 30 / 300 / 2 k / 5 k cps	
Return time	≤ 500 ms	
Min. signal width	RESET: ≈ 20 ms	
Input logic	Voltage input (PNP) - input impedance: ≤ 10.8 kΩ, [H]: 5 - 30 VDC≐, [L]: 0 - 2 VDC≐ No-voltage input (NPN) - short-circuit impedance: ≤ 470 Ω, short-circuit residual voltage: ≤ 1 VDC≐, open-circuit impedance: ≥ 100 kΩ	
One-shot output time	0.01 to 99.99 s	
Contact control output	Relay	
Type (1-stage)	Instantaneous SPDT (1c) × 1	
Type (2-stage)	Instantaneous SPST (1a) × 2	
Capacity	250 VAC ~ 3 A, 30 VDC≐ 3 A resistive load	
Solid-state control output	NPN open collector	
Type (1-stage)	× 1	
Type (2-stage)	× 2	
Capacity	≤ 30 VDC≐, 100 mA, residual voltage: ≤ 1 VDC≐	
Unit weight (packaged)	1-stage setting: ≈ 180 g (≈ 245 g) 2-stage setting: ≈ 200 g (≈ 265 g) Indicator: ≈ 160 g (≈ 225 g)	
Approval	CE, RoHS, ENEC	
Power supply	100 - 240 VAC ~ ± 10 % 50 / 60 Hz	
Power consumption	Dependent on the output	
1-stage setting	≤ 4.6 VA	
2-stage setting	≤ 5.8 VA	
Indicator	≤ 3.8 VA	
External supply power	≤ 12 VDC≐ ± 10 % 50 mA	
Memory retention	≈ 10 years (non-volatile semiconductor memory type)	
Insulation resistance	≥ 100 MΩ (500 VDC≐ megger)	
Dielectric strength	Between all terminals and case: 2,000 VAC ~ 50 / 60 Hz for 1 min	
Noise immunity	± 2 kV square wave noise (pulse width: 1 μs) by the noise simulator	
Vibration	0.75 mm double amplitude at frequency of 10 to 55 Hz (for 1 minute) in each X, Y, Z direction for 1 hour	
Vibration (malfunction)	0.5 mm double amplitude at frequency of 10 to 55 Hz (for 1 minute) in each X, Y, Z direction for 10 minute	
Shock	300 m/s ² (≈ 30 G) in each X, Y, Z direction for 3 times	
Shock (malfunction)	100 m/s ² (≈ 10 G) in each X, Y, Z direction for 3 times	
Relay life cycle	Mechanical: ≥ 5,000,000 operations Electrical: ≥ 100,000 operations (250 VAC ~ 3 A resistive load)	
Ambient temperature	-10 to 55 °C, storage: -25 to 65 °C (no freezing or condensation)	
Ambient humidity	35 to 85 %RH, storage: 35 to 85 %RH (no freezing or condensation)	
Protection rating	IP20 (front part, IEC standard)	



E8. Timers

Analog and digital timers are widely used in various industrial processes to control timing of devices or monitor life cycles of devices.

E8-1	Analog	ATM Series	W 21.5 × H 28 mm Analog Timers
		ATS Series	W 38 × H 42 mm Analog Timers
		ATS8W / 11W Series	W 38 × H 42 mm Twin Analog Timers
		ATS8P Series	W 38 × H 42 mm Power OFF Delay Analog Timers
		ATS8SD-4 Series	W 38 × H 42 mm Star-Delta Analog Timers
		ATN Series	W 48 × H 48 mm Analog Timers
		AT8PSN / AT8PMN Series	W 48 × H 48 mm Power OFF Delay Analog Timers
		ATE8 Series	W 48 × H 48 mm Power ON Delay Analog Timers
		AT8SDN Series	W 48 × H 48 mm Star-Delta Analog Timers
		E8-2	Digital
LE7M-2 Series	W 72 × H 72 mm LCD Week / Year Digital Timers		
LE8N Series	LCD Digital Timers (Indicator)		
E8-3	8-Pin Plug	FSE Series	8-Pin Plug Digital Timers with Thumbwheel Switch

W 21.5 × H 28 mm

Analog Timers

ATM Series



Features

- Miniature Size (W 21.5 × H 28 × L 59.3 mm)
- 4c (4PDT) contact (250 VAC~, 3 A)
- High precise time control
- Easy time setting using dial
- Various time ranges:
0.1 sec to 3 hour
(11 time ranges, different by models)
- Power supply
ATM4-2: 24 VDC≐
ATM4-5: 220 VAC~ 50 / 60 Hz
ATM4-6: 110 VAC~ 50 / 60 Hz

Specifications

Model	ATM4-2□□	ATM4-5□□	ATM4-6□□
Function	Power ON Delay		
Return time	≤ 100 ms		
Time operation	Power ON Start		
Control output	Relay		
Contact type	4PDT (4c)		
Contact capacity	250 VAC~ 3 A, 24 VDC≐ 3 A resistive load		
Error	Repeat: ≤ ± 0.5% ± 10 ms SET: ≤ ± 10% ± 50 ms Voltage: ≤ ± 0.5% ± 10 ms Temp.: ≤ ± 2% ± 10 ms		
Approval	CE ENEC		
Unit weight (packaged)	≈ 42 g (≈ 48 g)		
Power supply	24 VDC≐	220 VAC~ 50 / 60 Hz	110 VAC~ 50 / 60 Hz
Allowable voltage range	21.6 - 26.4 VDC≐	200 - 230 VAC~ 50 / 60 Hz	100 - 120 VAC~ 50 / 60 Hz
Power consumption	≈ 1.2 W	≈ 3 VA	≈ 3 VA
Insulation resistive	≥ 100 MΩ (500 VDC≐ megger)		
Dielectric strength	3,000 VAC~ at 50 / 60 Hz for 1 min		
Noise immunity	± 2 kV square-wave noise by noise simulator (pulse width 1 μs)		
Vibration	0.75 mm double amplitude at frequency of 10 to 55 Hz (for 1 min) in each X, Y, Z direction for 1 hour		
Vibration (malfunction)	0.5 mm double amplitude at frequency of 10 to 55 Hz (for 1 min) in each X, Y, Z direction for 10 min		
Shock	300 m/s ² (≈ 30 G) in each X, Y, Z direction for 3 times		
Shock (malfunction)	100 m/s ² (≈ 10 G) In each X, Y, Z direction for 3 times		
Relay life cycle	Mechanical: ≥ 10,000,000 operations Electrical: ≥ 200,000 operations		
Ambient temperature	-10 to 50 °C, storage: -25 to 65 °C (no freezing or condensation)		
Ambient humidity	35 to 85%RH, storage: 35 to 85%RH (no freezing or condensation)		

W 38 × H 42 mm

Analog Timers

ATS Series



Features

- Wide power supply range:
100 - 240 VAC~ 50 / 60 Hz, 24 - 240 VDC==
/ 24 VAC~ 50 / 60 Hz, 24 VDC== / 12 VDC==
- Various output operations (6 operation modes)
- Multi time range (12 types of time range)
- Wide time setting range (0.1 sec to 30 hour)
- Close and DIN rail mounting with the dedicated socket (PS-M8) width 41 mm (ATS8)
- Easy mounting and installation / maintenance with the dedicated bracket for DIN 48 × 48 mm

Specifications

Model	ATS8-□□□	ATS11-□□□	ATS11-□□E
Function	Multi Function Timer		
Return time	≤ 100 ms		
Time operation	Power ON Start	Signal ON Start	
Input	-	START, INHIBIT, RESET	
Min. signal width	-	≈ 50ms	
No-voltage input	-	Short-circuit impedance: ≤ 1 kΩ Short-circuit residual voltage: ≤ 0.5 VDC== Open-circuit impedance: ≥ 100 kΩ	
Control output	Relay		
Contact type	Time limit DPDT (2c), Instantaneous SPDT (1c) + Time limit SPDT (1c)	Time limit DPDT (2c)	Instantaneous SPDT (1c) + Time limit SPDT (1c)
Contact capacity	250 VAC~ 3 A, 30 VDC== 3 A resistive load	250 VAC~ 3 A, 24 VDC== 3 A resistive load	
Error	Repeat: ≤ ± 0.2% ± 10 ms SET: ≤ ± 5% ± 50 ms Voltage: ≤ ± 0.5% Temp.: ≤ ± 2%		
Approval	CE		
Unit weight (packaged)	≈ 70 g (≈ 95 g)		
Power supply	12 VDC== ±10%	24 VAC~ ±10% 50 / 60 Hz, 24 VDC== ±10%	100 - 240 VAC~ ±10% 50 / 60 Hz, 24 - 240 VDC== ±10%
Power consumption	It depends on the plug type and output.		
ATS8-□□□	DC: ≤ 1.5 W	AC: ≤ 4.5 VA DC: ≤ 2 W	AC: ≤ 4.2 VA DC: ≤ 2 W
ATS11-□□□	DC: ≤ 1 W	AC: ≤ 4 VA DC: ≤ 1.5 W	AC: ≤ 3.5 VA DC: ≤ 2 W
ATS11-□□E	DC: ≤ 1.5 W	AC: ≤ 4.5 VA DC: ≤ 2 W	AC: ≤ 4.2 VA DC: ≤ 2 W
Insulation resistive	≥ 100 MΩ (500 VDC== megger)		
Dielectric strength	2,000 VAC~ at 50 / 60 Hz for 1 min		
Noise immunity	It depends on the power supply.		
ATS□-1□□	± 500 V square-wave noise by noise simulator (pulse width 1 μs)		
ATS□-2□□			
ATS□-4□□	± 2kV square-wave noise by noise simulator (pulse width 1 μs)		
Vibration	0.75 mm double amplitude at frequency of 10 to 55 Hz (for 1 min) in each X, Y, Z direction for 1 hour		
Vibration (malfunction)	0.5 mm double amplitude at frequency of 10 to 55 Hz (for 1 min) in each X, Y, Z direction for 10 min		
Shock	300 m/s ² (≈ 30 G) in each X, Y, Z direction for 3 times		
Shock (malfunction)	100 m/s ² (≈ 10 G) in each X, Y, Z direction for 3 times		
Relay life cycle	Mechanical: ≥ 10,000,000 operations Electrical: ≥ 100,000 operations (250 VAC~ 3 A resistive load)		
Ambient temperature	-10 to 55 °C, storage: -25 to 65 °C (no freezing or condensation)		
Ambient humidity	35 to 85 %RH, storage: 35 to 85 %RH (no freezing or condensation)		

W 38 × H 42 mm

Twin

Analog Timers



ATS8W / 11W Series



Features

- Wide power supply range:
100 - 240 VAC~ 50 / 60 Hz, 24 - 240 VDC≐ universal / 24 VAC~ 50 / 60 Hz, 24 VDC≐ / 12 VDC≐
- Various output operations (6 operation modes)
- Multi time range (12 types of time range)
- Twin timer to set ON / OFF time individually
- Close and DIN rail mounting with the dedicated socket (PS-M8) width 41 mm (ATS8W)
- Easy installation / maintenance with the dedicated bracket for DIN 48 × 48 mm

Specifications

Model	ATS□W-1□	ATS□W-2□	ATS□W-4□
Function	ON / OFF Flicker operation		
Return time	≤ 100 ms		
Time operation	Power ON Start		
Control output	Relay		
Contact type	Time limit DPDT (2c), Instantaneous SPDT (1c) + Time limit SPDT (1c)		
Contact capacity	250 VAC~ 3 A, 30 VDC≐ 3 A resistive load		
Error	Repeat: ≤ ± 0.2% ± 10 ms SET: ≤ ± 5% ± 50 ms Voltage: ≤ ± 0.5% Temp.: ≤ ± 2%		
Approval	CE  ENEC  ERI		
Unit weight (packaged)	≈ 75 g (≈ 100 g)		
Power supply	12 VDC≐	24 VAC~ ± 10% 50 / 60 Hz, 24 VDC≐ ± 10%	100 - 240 VAC~ ± 10% 50 / 60 Hz, 24 - 240 VDC≐ ± 10%
Power consumption	DC: ≤ 1.5 W	AC: ≤ 4.5 VA DC: ≤ 2 W	AC: ≤ 4.2 VA DC: ≤ 2 W
Insulation resistive	≥ 100 MΩ (500 VDC≐ megger)		
Dielectric strength	2,000 VAC~ at 50/60 Hz for 1 min		
Noise immunity	± 500 V square-wave noise by noise simulator (pulse width 1 μs)		± 2kV square-wave noise by noise simulator (pulse width 1 μs)
Vibration	0.75 mm double amplitude at frequency of 10 to 55 Hz (for 1 min) in each X, Y, Z direction for 1 hour		
Vibration (malfunction)	0.5 mm double amplitude at frequency of 10 to 55 Hz (for 1 min) in each X, Y, Z direction for 10 min		
Shock	300 m/s ² (≈ 30 G) in each X, Y, Z direction for 3 times		
Shock (malfunction)	100 m/s ² (≈ 10 G) In each X, Y, Z direction for 3 times		
Relay life cycle	Mechanical: ≥ 10,000,000 operations Electrical: ≥ 100,000 operations (250 VAC~ 3 A resistive load)		
Ambient temperature	-10 to 55 °C, storage: -25 to 65 °C (no freezing or condensation)		
Ambient humidity	35 to 85%RH, storage: 35 to 85%RH (no freezing or condensation)		

W 38 × H 42 mm

Power OFF Delay

Analog Timers

ATS8P Series



Features

- Control time range (ATS8P-□S: 0.1 to 10 sec, ATS8P-□M: 0.1 to 10 min)
- Direct reading for time setting and time range with easy adjustment
- Power supply:
100 - 120 VAC~ 50 / 60 Hz, 200 - 240 VAC~ 50 / 60 Hz, 24 VAC~ 50 / 60 Hz, 24 VDC≐ universal
- Close and DIN rail mounting with the dedicated socket (PS-M8) width 41 mm
- Easy mounting and installation / maintenance with the dedicated bracket for DIN 48 × 48 mm
- Application: Protection circuit when momentary power failure and start it again

Specifications

Model	ATS8P-2□	ATS8P-5□	ATS8P-6□
Function	Power OFF Delay		
Return time	≤ 100 ms		
Control output	Relay		
Contact type	Time limit DPDT (2c)		
Contact capacity	250 VAC~ 3 A, 30 VDC≐ 3 A resistive load		
Error	Repeat: ≤ ± 0.2% ± 10 ms SET: ≤ ± 5% ± 50 ms Voltage: ≤ ± 0.5% Temp.: ≤ ± 2%		
Time operation	Power OFF Start		
Approval	CE  ENEC  ERII		
Unit weight	SEC unit model: ≈ 80 g, MIN unit model: ≈ 85 g		
Power supply	24 VAC~ ± 10% 50 / 60 Hz, 24 VDC≐ ± 10%	200 - 240 VAC~ ± 10%, 50 / 60 Hz	100 - 120 VAC~ ± 10%, 50 / 60 Hz
Power consumption	AC: ≤ 0.2 VA DC: ≤ 0.2 W	AC: ≤ 1.5 VA	AC: ≤ 1.5 VA
Insulation resistive	100 MΩ (500 VDC≐ megger)		
Dielectric strength	2,000 VAC~ at 50/60 Hz for 1 min		
Noise immunity	± 2 kV square-wave noise by noise simulator (pulse width 1 μs)		
Vibration	0.75 mm double amplitude at frequency of 10 to 55 Hz (for 1 min) in each X, Y, Z direction for 1 hour		
Vibration (malfunction)	0.5 mm double amplitude at frequency of 10 to 55 Hz (for 1 min) in each X, Y, Z direction for 10 min		
Shock	300 m/s ² (≈ 30 G) in each X, Y, Z direction for 3 times		
Shock (malfunction)	100 m/s ² (≈ 10 G) In each X, Y, Z direction for 3 times		
Relay life cycle	Mechanical: ≥ 10,000,000 operations Electrical: ≥ 100,000 operations (250 VAC~ 3 A resistive load)		
Ambient temperature	-10 to 55 °C, storage: -25 to 65 °C (no freezing or condensation)		
Ambient humidity	35 to 85%RH, storage: 35 to 85%RH (no freezing or condensation)		

W 38 × H 42 mm

Star-Delta

Analog Timers

ATS8SD-4 Series



Features

- Wide power supply range:
100 - 240 VAC~ 50 / 60 Hz, 24 - 240 VDC=
- Wide time setting range and switching time
 - T1 (setting time): selectable 0.5 to 100 sec
 - T2 (switching time): selectable 0.05, 0.1, 0.2, 0.3, 0.4, 0.5 sec
- Close and DIN rail mounting with the dedicated socket (PS-M8) width 41 mm
- Easy installation / maintenance with the dedicated bracket for DIN 48 × 48 mm
- Application: Starting large capacity motors

Specifications

Model	ATS8SD-4
Function	Star-Delta Timer
Return time	≤ 100 ms
Time operation	Power ON Start
Control output	Relay
Contact type	Y Contact: Time limit SPST (1a), ΔContact: Time limit SPST (1a)
Contact capacity	250 VAC~ 3 A, 30 VDCc 3 A resistive load
Error	Repeat: ≤ ± 0.2% ± 10 ms Voltage: ≤ ± 0.5% Temp.: ≤ ± 2% Y setting time: ≤ ± 5% ± 50 ms Y - Δswitching time: ≤ ± 25%
Approval	CE, RoHS, ENEC
Unit weight	≈ 72 g
Power supply	100 - 240 VAC~ ± 10% 50 / 60 Hz, 24 - 240 VDC= ± 10%
Power consumption	AC: ≤ 3 VA, DC: ≤ 1.5 W
Insulation resistive	≥ 100 MΩ (500 VDC= megger)
Dielectric strength	2,000 VAC~ at 50 / 60 Hz for 1 min
Noise immunity	± 2 kV square-wave noise by noise simulator (pulse width 1 μs)
Vibration	0.75 mm double amplitude at frequency of 10 to 55 Hz (for 1 min) in each X, Y, Z direction for 1 hour
Vibration (malfunction)	0.5 mm double amplitude at frequency of 10 to 55 Hz (for 1 min) in each X, Y, Z direction for 10 min
Shock	300 m/s ² (≈ 30 G) in each X, Y, Z direction for 3 times
Shock (malfunction)	100 m/s ² (≈ 10 G) in each X, Y, Z direction for 3 times
Relay life cycle	Mechanical: ≥ 10,000,000 operations Electrical: ≥ 100,000 operations (250 VAC~ 3 A resistive load)
Ambient temperature	-10 to 55 °C, storage: -25 to 65 °C (no freezing or condensation)
Ambient humidity	35 to 85%RH, storage: 35 to 85%RH (no freezing or condensation)

W 48 × H 48 mm

Analog Timers

ATN Series



Features

- Wide range of power supply:
100 - 240 VAC \sim 50 / 60 Hz, 24 - 240 VDC \equiv / 24 VAC \sim 50 / 60 Hz, 24 VDC \equiv / 12 VDC \equiv
- Various output operation (6 operation modes)
- Multi time range (16 types of time range)
- Wide control time (0.05 sec to 100 hour)
- Easy setting of time, time range, output operation mode
- Easy to check output status by indicator

Specifications

Model	AT8N-□	AT11DN-□	AT11EN-□
Function	Multi Function Timer		
Return time	≤ 100 ms		
Time operation	Power ON Start	Signal ON Start	
Input	-	INHIBIT, START, RESET	
Min. signal width	-	≈ 50 ms	
No-voltage input	-	Short-circuit impedance: ≤ 1 kΩ Short-circuit residual voltage: ≤ 0.5 VDC \equiv Open-circuit impedance: ≥ 100 kΩ	
Control output	Relay		
Contact type	Time limit DPDT (2c), Time limit SPDT (1c) + Instantaneous SPDT (1c)	Time limit DPDT (2c)	Time limit SPDT (1c) + Instantaneous SPDT (1c)
Contact capacity	250 VAC \sim 5 A, 30 VDC \equiv 5 A resistive load	250 VAC \sim 5 A, 24 VDC \equiv 5 A resistive load	250 VAC \sim 5 A, 30 VDC \equiv 5 A resistive load
Error	Repeat: ≤ ± 0.2% ± 10 ms SET: ≤ ± 5% ± 50 ms Voltage: ≤ ± 0.5% Temp.: ≤ ± 2%		
Approval	CE, RoHS, ENEC		
Unit weight (packaging)	≈ 86.71 g (≈ 134.12 g)	≈ 85 g (≈ 132.2 g)	≈ 87.5 g (≈ 134.7 g)
Power supply	100 - 240 VAC \sim ± 10% 50 / 60 Hz, 24 - 240 VDC \equiv ± 10%	12 VDC \equiv ± 10%	24 VAC \sim ± 10% 50 / 60 Hz, 24 VDC \equiv ± 10%
Power consumption	It depends on the model.		
AT8N-□	AC: ≤ 4.3 VA DC: ≤ 2 W	DC: ≤ 1.5 W	AC: ≤ 4.5 VA DC: ≤ 2 W
AT11DN-□	AC: ≤ 3.5 VA DC: ≤ 1.5 W	DC: ≤ 1 W	AC: ≤ 4 VA DC: ≤ 1.5 W
AT11EN-□	AC: ≤ 4.3 VA DC: ≤ 2 W	DC: ≤ 1.5 W	AC: ≤ 4.5 VA DC: ≤ 2 W
Insulation resistive	≥ 100 MΩ (500 VDC \equiv megger)		
Dielectric strength	2,000 VAC \sim 50 / 60 Hz for 1 min		
Noise immunity	± 2 kV square-wave noise by noise simulator (pulse width 1 μs)	± 500 V square-wave noise by noise simulator (pulse width 1 μs)	
Vibration	0.75 mm double amplitude at frequency of 10 to 55 Hz (for 1 min) in each X, Y, Z direction for 1 hour		
Vibration (malfunction)	0.5 mm double amplitude at frequency of 10 to 55 Hz (for 1 min) in each X, Y, Z direction for 10 min		
Shock	300 m/s ² (≈ 30 G) in each X, Y, Z direction for 3 times		
Shock (malfunction)	100 m/s ² (≈ 30 G) in each X, Y, Z direction for 3 times		
Relay life cycle	Mechanical: ≥ 10,000,000 operations Electrical: ≥ 100,000 operations (250 VAC \sim 5 A resistive load)		
Ambient temperature	-10 to 55 °C, storage: -25 to 65 °C (no freezing or condensation)		
Ambient humidity	35 to 85%RH, storage: 35 to 85%RH (no freezing or condensation)		

W 48 × H 48 mm

Power OFF Delay

Analog Timers

AT8PSN / AT8PMN Series



Features

- Time setting range (AT8PSN: 0.05 to 10 sec, AT8PMN: 0.05 to 10 min)
- Simple time setup and direct read of time range
- Power supply:
100 - 120 VAC~ 50 / 60 Hz / 200 - 240 VAC~ 50 / 60 Hz / 100/110 VDC== / 24 VAC~ 50 / 60 Hz, 24 VDC==
- Application: Protect circuit when momentary power failure and start it again

Specifications

Model	AT8P□	AT8P□-2	AT8P□-6	AT8P□-7
Function	Power OFF Delay			
Time operation	Power OFF Start			
Control output	Relay			
Contact type	Time limit DPDT (2c)			
Contact capacity	250 VAC~ 3 A, 30 VDC== 3 A resistive load			
Error	Repeat: $\leq \pm 0.2\% \pm 10$ ms SET: $\leq \pm 5\% \pm 50$ ms Voltage: $\leq \pm 0.5\%$ Temp.: $\leq \pm 2\%$			
Approval	CE  ENEC			
Unit weight	≈ 100 g			
Power supply	200 - 240 VAC~ $\pm 10\%$, 50 / 60 Hz	24 VAC~ $\pm 10\%$ 50 / 60 Hz, 24 VDC== $\pm 10\%$	100 - 120 VAC~ $\pm 10\%$, 50 / 60 Hz	100 / 110 VDC== $\pm 10\%$
Power consumption	AC: ≤ 1.5 VA	AC: ≤ 0.2 VA DC: ≤ 0.2 W	AC: ≤ 1.5 VA	DC: ≤ 0.8 W
Insulation resistive	≥ 100 M Ω (500 VDC== megger)			
Dielectric strength	2,000 VAC~ at 50 / 60 Hz for 1 min			
Noise immunity	± 2 kV square-wave noise by noise simulator (pulse width 1 μ s)			
Vibration	0.75 mm double amplitude at frequency of 10 to 55 Hz (for 1 min) in each X, Y, Z direction for 1 hour			
Vibration (malfunction)	0.5 mm double amplitude at frequency of 10 to 55 Hz (for 1 min) in each X, Y, Z direction for 10 min			
Shock	300 m/s ² (≈ 30 G) in each X, Y, Z direction for 3 times			
Shock (malfunction)	100 m/s ² (≈ 10 G) In each X, Y, Z direction for 3 times			
Relay life cycle	Mechanical: $\geq 10,000,000$ operations Electrical: $\geq 100,000$ operations (250 VAC~ 3 A resistive load)			
Ambient temperature	-10 to 55 °C, storage: -25 to 65 °C (no freezing or condensation)			
Ambient humidity	35 to 85%RH, storage: 35 to 85%RH (no freezing or condensation)			

W 48 × H 48 mm

Power ON Delay

Analog Timers

ATE8 Series



Features

- DIN W 48 × H 48 mm
- Easy and simple time setting
- Cost-effective
- Easy time setting
- Wide range of time
- Power supply: 100 - 240 VAC~ 50 / 60 Hz, 24 - 240 VDC=

Specifications

Model	ATE8-4□	ATE8-4□D	ATE8-4□E
Function	Power ON Delay		
Return time	≤ 200 ms		
Time operation	Power ON Start		
Control output	Relay		
Contact type	Time limit SPDT (1c) + Instantaneous SPST (1a)	Time limit DPDT (2c)	Time limit SPDT (1c) + Instantaneous SPDT (1c)
Contact capacity	250 VAC~ 3A, 30 VDC= 3 A resistive load		
Error	Repeat: ≤ ± 0.3% ± 10 ms SET: ≤ ± 10% ± 50 ms Voltage: ≤ ± 0.5% ± 10 ms Temp.: ≤ ± 2% ± 10 ms		
Approval	CE, RoHS, ENEC		
Unit weight (packaged)	≈ 75 g (≈ 122.2 g)		
Power supply	100 - 240 VAC~ ±10% 50 / 60 Hz, 24 - 240 VDC= ±10%		
Power consumption	AC: ≤ 3.5 VA, DC: ≤ 2 W		
Insulation resistive	≥ 100 MΩ (500 VDC= megger)		
Dielectric strength	2,000 VAC~ at 50 / 60 Hz for 1 min		
Noise immunity	± 2kV square-wave noise by noise simulator (pulse width 1 μs)		
Vibration	0.75 mm double amplitude at frequency of 10 to 55 Hz (for 1 min) in each X, Y, Z direction for 1 hour		
Vibration (malfunction)	0.5 mm double amplitude at frequency of 10 to 55 Hz (for 1 min) in each X, Y, Z direction for 10 min		
Shock	300 m/s ² (≈ 30 G) in each X, Y, Z direction for 3 times		
Shock (malfunction)	100 m/s ² (≈ 10 G) In each X, Y, Z direction for 3 times		
Relay life cycle	Mechanical: ≥ 5,000,000 operations Electrical: ≥ 100,000 operations (250 VAC~ 3 A resistive load)		
Ambient temperature	-10 to 55 °C, storage: -25 to 65 °C (no freezing or condensation)		
Ambient humidity	35 to 85%RH, storage: 35 to 85%RH (no freezing or condensation)		
Protection rating	IP40 (front part, IEC standard)		

W 48 × H 48 mm

Star-Delta

Analog Timers

AT8SDN Series



Features

- Wide range of power supply:
100 - 240 VAC~ 50 / 60 Hz, 24 - 240 VDC= universal
- Wide range of setting time and switching time
- T1 (setting time): Selectable 0.5 to 100 sec
- T2 (switching time): Selectable 0.05, 0.1, 0.2, 0.3, 0.4, 0.5 sec
- Simple setting time, switching time operation
- Easy to check output status by LED display
- Application: Starting large capacity motors

Specifications

Model	AT8SDN
Function	Star-Delta Timer
Return time	≤ 100 ms
Time operation	Power ON Start
Control output	Relay
Contact type	Y Contact: Time limit SPST (1a), ΔContact: Time limit SPST (1a)
Contact capacity	250 VAC~ 5 A, 30 VDC= 5 A resistive load
Error	Repeat: ≤ ± 0.2% ± 10 ms Voltage: ≤ ± 0.5% Temp.: ≤ ± 2% Y setting time: ≤ ± 5% ± 50 ms Y - Δswitching time: ≤ ± 25%
Approval	CE, RoHS, ENEC
Weight	≈ 90 g
Power supply	100 - 240 VAC~ ± 10% 50 / 60 Hz, 24 - 240 VDC= ± 10%
Power consumption	AC: ≤ 3.2 VA, DC: ≤ 1.5 W
Insulation resistive	≥ 100 MΩ (500 VDC= megger)
Dielectric strength	2,000 VAC~ at 50 / 60 Hz for 1 min
Noise immunity	± 2 kV square-wave noise by noise simulator (pulse width 1 μs)
Vibration	0.75 mm double amplitude at frequency of 10 to 55 Hz (for 1 min) in each X, Y, Z direction for 1 hour
Vibration (malfunction)	0.5 mm double amplitude at frequency of 10 to 55 Hz (for 1 min) in each X, Y, Z direction for 10 min
Shock	300 m/s ² (≈ 30 G) in each X, Y, Z direction for 3 times
Shock (malfunction)	100 m/s ² (≈ 10 G) in each X, Y, Z direction for 3 times
Relay life cycle	Mechanical: ≥ 10,000,000 operations Electrical: ≥ 100,000 operations (250 VAC~ 5 A resistive load)
Ambient temperature	-10 to 55 °C, storage: -25 to 65 °C (no freezing or condensation)
Ambient humidity	35 to 85%RH, storage: 35 to 85%RH (no freezing or condensation)

LCD

Digital Timers

LE4S Series



Features

- Mounting space saving with compact design: downsized by approx. 22 % in depth compared to existing models (length of panel on the back side is 56 mm)
- Available to set each value and time range separately when choosing Flicker (FK, FK I) or ON-OFF Delay (ON OFF D, ON OFF D I) output mode
- Adds Flicker 1 mode (LE4SA)
- Settable One-shot output time (0.01 to 99.99 sec) (existing model: fixed 0.5 sec)
- Configurable time range (added 9.999 sec): settable by 0.001 sec unit
- Selectable min. input time: 1 ms or 20 ms (LE4S)
- Improved return time: 100 ms
- Backlight ON / OFF function
- Wide time range (0.01 sec to 9999 hour)
- Lock setting function for saving setting data
- Soft touch setting
- High visibility display with backlight

Specifications

Model		LE4S	LE4SA
Function		MULTI time, MULTI operation	
Display method		LCD (Backlight)	
Return time		≤ 100 ms	
Time operation		Signal ON Start	Power ON Start
Input signal		START, INHIBIT, RESET	
Min. signal width		≈ 1, 20 ms	-
No-voltage input		Short-circuit impedance: ≤ 1 kΩ Short-circuit residual voltage : ≤ 0.5 VDC≐ Open-circuit impedance: ≥ 100 kΩ	-
Control output		Relay	
Contact type		Time limit SPDT (1c)	Time limit DPDT (2c), Time limit SPDT (1c) + Instantaneous SPDT (1c) (depends on operation mode)
Contact capacity		250 VAC~ 5 A, 30 VDC≐ 5 A resistive load	250 VAC~ 3 A, 30 VDC≐ 3 A resistive load
Error	Repeat	Power ON Start : ≤ ± 0.01% ± 0.05 sec	≤ ± 0.01% ± 0.05 sec
	SET	Signal ON Start : ≤ ± 0.005% ± 0.03 sec	
	Voltage		
	Temp.		
Approval		CE cULus ENEC	
Unit weight		≈ 98 g	
Model		LE4S	LE4SA
Power supply		24 - 240 VAC~ ± 10% 50 / 60 Hz, 24 - 240 VDC≐ ± 10%	
Power consumption		AC: ≤ 4.5 VA, DC: ≤ 2 W	AC: ≤ 4 VA, DC: ≤ 1.6 W
Insulation resistive		100 MΩ (500 VDC≐ megger)	
Dielectric strength		2000 VAC~ 50 / 60 Hz for 1 min	
Noise immunity		± 2 kV square-wave noise by noise simulator (pulse width 1 μs)	
Vibration		0.75 mm double amplitude at frequency of 10 to 55 Hz (for 1 min) in each X, Y, Z direction for 1 hour	
Vibration (malfunction)		0.5 mm double amplitude at frequency of 10 to 55 Hz (for 1 min) in each X, Y, Z direction for 10 min	
Shock		300 m/s ² (≈ 30 G) in each X, Y, Z direction for 3 times	
Shock (malfunction)		100 m/s ² (≈ 10 G) in each X, Y, Z direction for 3 times	
Relay life cycle		Mechanical: ≥ 10,000,000 operations Electrical: ≥ 100,000 operations	
Ambient temperature		-10 to 55 °C, storage: -25 to 65 °C (no freezing or condensation)	
Ambient humidity		35 to 85 %RH, storage: 35 to 85 %RH (no freezing or condensation)	

W 72 × H 72 mm

LCD Week / Year

Digital Timers

LE7M-2 Series



Features

- Various external input functions
- Clear display with built-in backlight
- Easy to check and change the program setting
- Customizable weekly or yearly unit time setting and control by user
- Includes daylight saving time function
- Built-in 2 independent control output (relay)
- Flush mount or Surface / DIN rail mount available (depending on the model)

Specifications

Model	LE7M-2B	LE7M-2D
Number of steps for the program	64 steps for weekly, 32 steps for yearly	
Operation mode	Weekly: ON/OFF, pulse, cycle operation Yearly: ON/OFF, pulse operation	
Temperature error	≤ (±0.01%±0.05 sec), at a ratio by the setting time	
Cyclic error	±15 sec/month (25 °C, ±4 sec/1 week)	
Memory retention	≥ 5 years (25 °C)	
External input	Open or short circuit by a contact device (switch or relay)	
Mounting type	Flush mount	Surface or DIN rail mount
Approval	CE 	CE 
Unit weight (packaged)	≈ 207 g (≈ 337 g)	≈ 208 g (≈ 361 g)
Power supply	100 - 240 VAC~ ±10%, 50/60 Hz	
Power consumption	≤ 4.2 VA	
Control output	Relay	
Contact type	SPDT (1c)	
Contact capacity	Resistive load: 250 VAC~ 15 A	
Number of circuits	Independent 2 circuits (1c × 2)	
Mechanical life expectancy	≥ 10,000,000 operations (switching capacity: 30 times/min)	
Electrical life expectancy	≥ 50,000 operations (switching capacity: 20 times/min, resistive load: 250 VAC~ 15 A)	
Insulation resistive	≥ 100 MΩ (500 VDC= megger)	
Noise immunity	± 2 kV square-wave noise by noise simulator (pulse width 1 μs)	
Dielectric strength	Between primary terminal and case : 3,000 VAC~ at 50/60 Hz for 1 min	
Vibration	0.75 mm double amplitude at frequency of 10 to 55 Hz (for 1 min) in each X, Y, Z direction for 2 hours	
Vibration (malfunction)	0.5 mm double amplitude at frequency of 10 to 55 Hz (for 1 min) in each X, Y, Z direction for 10 min	
Shock	300 m/s ² (≈ 30 G) in each X, Y, Z direction for 3 times	
Shock (malfunction)	100 m/s ² (≈ 10 G) in each X, Y, Z direction for 3 times	
Ambient temperature	-10 to 55 °C, storage: -25 to 65 °C (no freezing or condensation)	
Ambient humidity	35 to 85%RH, storage: 35 to 85%RH (no freezing or condensation)	

LCD

Digital Timers

(Indicator)

LE8N Series



Features

- No additional power due to internal battery
- Signal input method: no-voltage input, voltage input, free voltage input
- Screw terminal type (attaching terminal cover)
- LCD display, backlight model
- Protection rating: IP66

Specifications

Model	LE8N-BN	LE8N-BN-L	LE8N-BV	LE8N-BV-L	LE8N-BF
Display digits	8-digit				
Display method	LCD Zero Blanking (character size: W 3.4 × H 8.7 mm)				
Operation method	Count up				
Time range	0 to 99999999				
Error	Time / Temp.: ± 0.01%				
Input method	No-voltage input		Voltage input		Free voltage input
Counting input (H)	Short Residual voltage: ≤ 0.5 VDC≐ Max. impedance: ≤ 10 kΩ		4.5 - 30 VDC≐		24 - 240 VAC~ / 6 - 240 VDC≐
Counting input (L)	Open Min. impedance: ≥ 750 kΩ		0 - 2 VDC≐		0 - 2 VAC~ / 0 - 2.4 VDC≐
RESET input	No-voltage input		Voltage input		No-voltage input
Min. signal width	SIGNAL INPUT, RESET: ≥ 20 ms				
Unit weight (packaged)	≈ 50 g (≈ 96 g)				
Approval	CE cTUVus ENEC				
Power supply	Built-in battery (CR2477)				
Battery life cycle	≥ 10 years (at ≈ 20 °C)				
Backlight power	24 VDC≐ ± 10%				
Insulation resistance	≥ 100 MΩ (500 VDC≐ megger)				
Dielectric strength ⁰¹⁾	2,000 VAC~ at 60 Hz for 1 min				
Vibration	0.75 mm double amplitude at frequency of 10 to 55Hz (for 1 min) in each X, Y, Z direction for 1 hour				
Vibration (malfunction)	0.5 mm double amplitude at frequency of 10 to 55Hz (for 1 min) in each X, Y, Z direction for 10 min				
Shock	300 m/s ² (≈ 30 G) in each X, Y, Z direction for 3 times				
Shock (malfunction)	100 m/s ² (≈ 10 G) in each X, Y, Z direction for 3 times				
Ambient temperature	-10 to 55 °C, storage: -25 to 65 °C (no freezing or condensation)				
Ambient humidity	35 to 85%RH, storage: 35 to 85%RH (no freezing or condensation)				
Protection rating	IP66 (front part, when using the rubber waterproof ring, IEC standard)				

⁰¹⁾ No-voltage input, voltage input: between all terminals and case
Free voltage input: between free voltage input terminal and RESET input terminal, between all terminals and case

8-Pin Plug Digital Timers with Thumbwheel Switch

FSE Series



Features

- Wide range of the time selection (0.01 sec to 9999.9 hour)
- Selectable voltage input (PNP) method or no-voltage input (NPN) method
- Dot for Decimal Point / Hour. Min. Sec. by RESET key
- Wide range of power supply:
100 - 240 VAC~ 50 / 60 Hz, 24 VAC~ 50 / 60 Hz, 24 - 48 VDC≐ universal
- Memory protection for 10 years (using non-volatile semiconductor)
- Built-in Microprocessor

Specifications

Model	FS4E-1P2	FS5E-1P4	FS5E-14
Display digits	4-digit		5-digit
Character size	W 3.8 × H 7.6 mm		W 4 × H 8 mm
Return time	≤ 500 ms		
Time operation	Power ON Start		
Min. signal width	RESET, INHIBIT: ≈ 20 ms		
Input logic	Voltage input (PNP) - input impedance: ≤ 10.8 kΩ, [H]: 5 - 30 VDC≐, [L]: 0 - 2 VDC≐ No-voltage input (NPN) - short-circuit impedance: ≤ 470 Ω, - short-circuit residual voltage: ≤ 1 VDC≐ - open-circuit impedance: ≥ 100 kΩ		
One-shot output time	0.05 to 5 sec		
Control output	Relay		-
Contact type	Time limit SPDT (1c)		-
Contact capacity	250 VAC~ 3 A, 30 VDC≐ 3 A resistive load		-
Error	Repeat / SET / Voltage / Temp.: ≤ ± 0.01% ± 0.05 sec		
Unit weight (packaged)	≈ 90 g (≈ 130 g)		≈ 80 g (≈ 120 g)
Approval	CE, RoHS, ENEC		
Voltage type	AC voltage type		AC / DC voltage type
Power supply	100 - 240 VAC~ ± 10% 50 / 60 Hz		24 VAC~ ± 10% 50 / 60 Hz, 24 - 48 VDC≐ ± 10%
Power consumption (FS5E-1P4)	≤ 4.6 VA		-
Power consumption (FS5E-14)	≤ 3.8 VA		-
Power consumption (FS4E-1P2)	-		AC: ≤ 3.5 VA DC: ≤ 2.3 W
Memory retention	≈ 10 years (non-volatile semiconductor memory type)		
Insulation resistance	≥ 100 MΩ (500 VDC≐ megger)		
Dielectric strength	2,000 VAC~ 50 / 60 Hz for 1 min (between all terminals and case)		
Noise immunity	± 2 kV square-wave noise by noise simulator (pulse width 1 μs)		± 500 V square-wave noise by noise simulator (pulse width 1 μs)
Vibration	0.75 mm double amplitude at frequency of 10 to 55 Hz (for 1 min) in each X, Y, Z direction for 1 hour		
Vibration (malfunction)	0.5 mm double amplitude at frequency of 10 to 55 Hz (for 1 min) in each X, Y, Z direction for 10 min		
Shock	300 m/s ² (≈ 30 G) in each X, Y, Z direction for 3 times		
Shock (malfunction)	100 m/s ² (≈ 10 G) in each X, Y, Z direction for 3 times		
Relay life cycle	Mechanical: ≥ 5,000,000 operations Electrical: ≥ 100,000 operations (250 VAC~ 3 A resistive load)		
Ambient temperature	-10 to 55 °C, storage: -25 to 65 °C (no freezing or condensation)		
Ambient humidity	35 to 85%RH, storage: 35 to 85%RH (no freezing or condensation)		
Protection rating	IP20 (front part, IEC standard)		

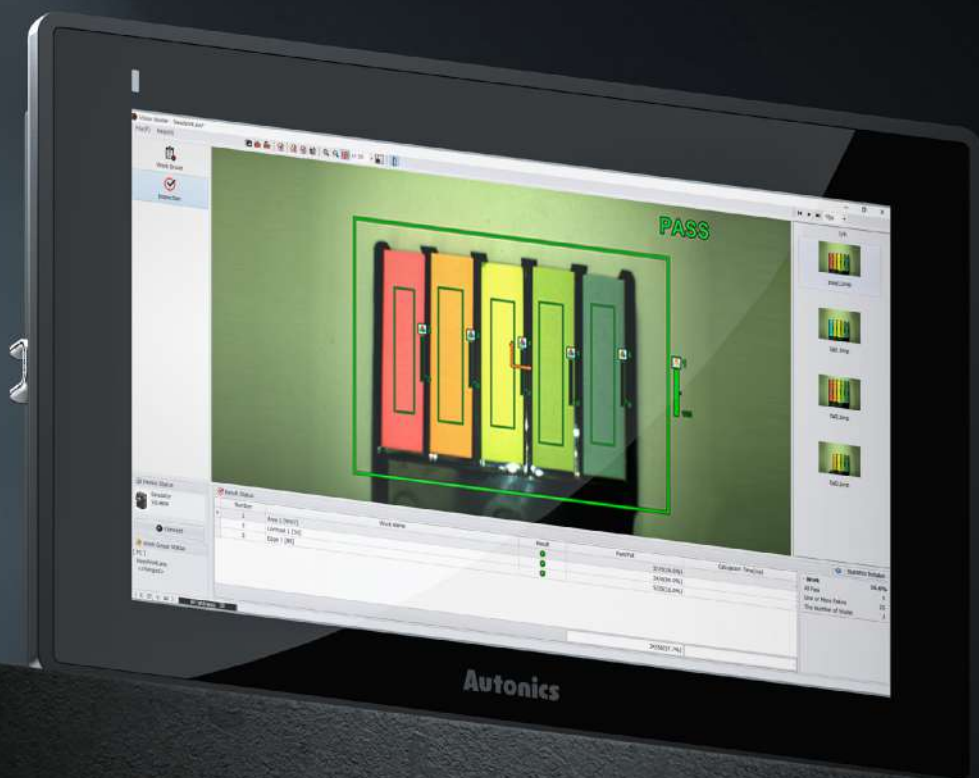

E9. Industrial PC

Industrial PCs can increase production efficiency and optimize performance of equipment by offering control and management solutions in industrial environments.

E9-1 Industrial PC

APC-1011

Panel PC

Panel PC



APC-1011



Features

- Familiar to user with the Microsoft Windows 10 OS
- Equipped with Quad core processor
- Fan less type with low noise, low heat and no need to replacing fan component
- Equipped with 10 inch wide IPS TFT LCD of 16,777,216 colors for realizing True color
- Possible to be touched with not only hand but also glove, pen tip or etc. with resistive type touch screen
- Lesser restrictions on place with display and system all-in-one panel PC
- Supporting various types of interface: HDMI, USB, VGA, Ethernet, Audio, Serial (RS232C / RS485 / RS422)
- Various methods of installation: installing on panel, installing with holder (VESA standard 100 × 100 mm)

Specifications

Model	APC-1011
Screen size	10.1 inch
LCD type	IPS TFT Color LCD
Resolution	WXGA 1280 × 800 pixel
Contrast	16:10
Display area	216.96 × 135.6 mm
Display color	16,777,216 color
LCD view angle (top/bottom/left/right)	Within 85° of each
Backlight	White LED
Backlight MTBF	50,000 hrs (LED Backlighting)
Luminance	350 cd/m ²
Touch	Resistive type
CPU	Integrated Intel®J3160/1.6 GHz Quad core processor, TDP 6 W
OS	Windows 10 IoT Enterprise Entry (64 bit)
Hard disk	mSATA 64 GB SSD
System memory	DDR3L 4 GB
Indicator	Power indicator (green)
Speaker	Stereo speaker 2 W + 2 W
Watch dog timer	Watch dog timer (1 to 255 seconds, software setting)
Battery life cycle	5 years at 25°C
Real-time controller	RTC embedded
Language	Korean, English
Approval	CE EMI
Unit weight (packaged)	≈ 1.6 kg (≈ 2 kg)
Serial interface	1 RS232C / RS422 / RS485 × 1 (jumper pin setting)
USB interface	USB 3.0 HOST × 1, USB 2.0 HOST × 2
Ethernet interface	Gigabit Ethernet × 2 (10/100/1000Base-T)
HDMI interface	1
VGA	1
Audio	1
Power supply	24 VDC≡
Allowable voltage range	90 to 110 % of power supply
Power consumption	≤ 30 W
Insulation resistance	≥ 100 MΩ (500 VDC≡ megger)
Ground	3rd ground (≤ 100 Ω)
Noise immunity	±0.5 kV square wave noise (pulse width: 1 μs) by the noise simulator
Dielectric strength	500 VAC~ 50/60 Hz for 1 minute
Vibration	0.75 mm double amplitude at frequency of 10 to 55Hz (for 1 minute) in each X, Y, Z direction for 1 hour
Vibration (malfunction)	0.5 mm double amplitude at frequency of 10 to 55Hz (for 1 minute) in each X, Y, Z direction for 10 minutes
Shock	300 m/s ² (≈ 30 G) in each X, Y, Z direction
Shock (malfunction)	100 m/s ² (≈ 10 G) in each X, Y, Z direction
Ambient temperature	0 to 50 °C, storage: -20 to 60 °C (no freezing or condensation)
Ambient humidity	35 to 85 %RH, storage: 35 to 85 %RH (no freezing or condensation)
Protection structure	IP65 (front panel, IEC standard)

F. Power Electronics

Power electronics, including switching mode power supplies, solid state relays, and power controllers, help maintain stable and efficient power supply.

- F1. SMPS
- F2. Solid State Relays
- F3. Power Controllers

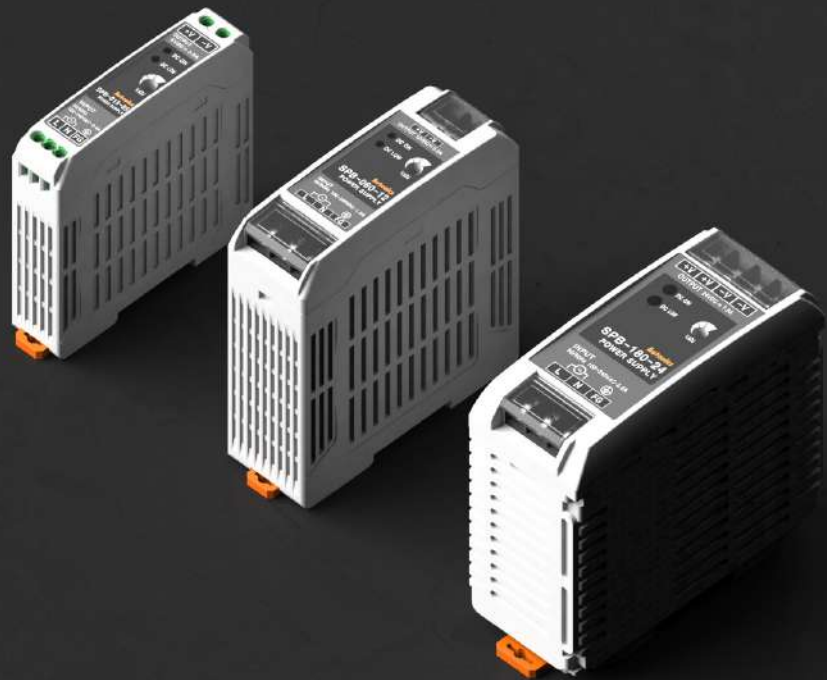



F



F

F1. Switching Mode Power Supplies

Switching mode power supplies are electronic power supplies which convert electrical power efficiently using a switching regulator.

F1-1	DIN-Rail Mount	SPB Series	DIN-Rail Mount Switching Mode Power Supplies
		SP Series	DIN-Rail Mount Switching Mode Power Supplies
F1-2	Panel Mount	SPA Series	Panel Mount Switching Mode Power Supplies
		SPA-400-24 Series	Panel Mount Switching Mode Power Supplies

DIN-Rail Mount Switching Mode Power Supplies

SPB Series











Features

- Efficient power conversion
 - High conversion efficiency up to 92 % with LLC circuit (SPB-240)
 - Stable power supply with minimal noise and ripple
- Space efficient design
 - Slim and compact size for maximum space efficiency
 - Uniform depth size (except SPB-015 / 030) for neat and tidy installation
- Safety and user-friendly features
 - Terminal protection cover (SPB-060 / 120 / 180 / 240)
 - Easy wiring with rising clamp terminal (SPB-015 / 030)
 - Inrush current prevention, output over-current prevention, output over-voltage prevention, circuit over-heating protection
 - Low output voltage indicator (red LED), output indicator (green LED)

Specifications

Output range		15 to 31.2 W					
Model		SPB-015-05	SPB-015-12	SPB-015-24	SPB-030-05	SPB-030-12	SPB-030-24
Output power		15 W	15.6 W	15.6 W	25 W	30 W	31.2 W
Input condition							
Voltage ⁽⁰¹⁾		100 - 240 VAC~ (permissible voltage: 85 - 264 VAC~ / 120 - 370 VDC=)					
Frequency		50 / 60 Hz					
Efficiency ⁽⁰²⁾ (Typical)	100 VAC~	77%	80%	83%	77%	82%	84%
	240 VAC~	76%	79%	82%	78%	83%	85%
Power factor ⁽⁰²⁾		-			-		
Max. current consumption ⁽⁰²⁾		0.4 A			0.8 A		
Current consumption ⁽⁰²⁾ (Typical)	100 VAC~	0.35 A	0.35 A	0.34 A	0.56 A	0.63 A	0.63 A
	240 VAC~	0.19 A	0.19 A	0.19 A	0.30 A	0.35 A	0.35 A
Output characteristics							
Voltage		5 VDC=	12 VDC=	24 VDC=	5 VDC=	12 VDC=	24 VDC=
Current		3 A	1.3 A	0.65 A	5 A	2.5 A	1.3 A
Voltage adjustment range		≤ ±10%			≤ ±10%		
Input variation ⁽⁰³⁾		≤ ±0.5%			≤ ±0.5%		
Load variation		≤ ±1%			≤ ±1%		
Ripple noise ^{(02) (04)}		≤ ±1.5%	≤ ±1%	≤ ±1%	≤ ±1.5%	≤ ±1%	≤ ±1%
Start-up time ⁽⁰²⁾ (Typical)	100 VAC~	500 ms	550 ms	650 ms	600 ms	550 ms	550 ms
	240 VAC~	550 ms	550 ms	650 ms	600 ms	550 ms	550 ms
Hold time ⁽⁰²⁾ (Typical)	100 VAC~	24 ms	25 ms	25 ms	20 ms	15 ms	15 ms
	240 VAC~	190 ms	190 ms	190 ms	130 ms	110 ms	110 ms
Protection							
Inrush current protection (Typical)	100 VAC~	7 A	7 A	7 A	7 A	7 A	6 A
	240 VAC~	32 A	30 A	31 A	29 A	31 A	29 A
Over-current protection ^{(04) (05)}		105 to 160%			105 to 160%		
Over-voltage protection ⁽⁰⁵⁾		-			-		
Output low-voltage indicate		4.2V ±10%	9.6V ±10%	20.0V ±10%	4.2V ±10%	9.6V ±10%	20.0V ±10%
Power factor correction circuit		-			-		
Approval ⁽⁰⁶⁾		CE ENEC ERI			CE ENEC ERI		
Unit weight (Package)		≈ 129 g (= 202 g)			≈ 176 g (= 249 g)		

Output range		60 to 120 W					
Model		SPB-060-12	SPB-060-24	SPB-060-48	SPB-120-12	SPB-120-24	SPB-120-48
Output power		60 W	60 W	62.4 W	96 W	120 W	120 W
Input condition							
Voltage ⁽⁰¹⁾		100 - 240 VAC~ (permissible voltage: 85 - 264 VAC~ / 120 - 370 VDC=)					
Frequency		50 / 60 Hz					
Efficiency ⁽⁰²⁾ (Typical)	100 VAC~	81%	84%	85%	82%	85%	85%
	240VAC~	83%	86%	87%	85%	88%	88%
Power factor ⁽⁰²⁾		-				≥ 0.9	
Max. current consumption ⁽⁰²⁾		1.6 A				1.9 A	
Current consumption ⁽⁰²⁾ (Typical)	100 VAC~	1.24 A	1.21 A	1.19 A	1.19 A	1.49 A	1.43 A
	240 VAC~	0.66 A	0.65 A	0.64 A	0.52 A	0.61 A	0.61 A
Output characteristics							
Voltage		12 VDC=	24 VDC=	48 VDC=	12 VDC=	24 VDC=	48 VDC=
Current		5 A	2.5 A	1.3 A	8 A	5 A	2.5 A
Voltage adjustment range		≤ ±5%			≤ ±5%		
Input variation ⁽⁰³⁾		≤ ±0.5%			≤ ±0.5%		
Load variation		≤ ±1%			≤ ±1%		
Ripple noise ^{(02) (04)}		≤ ±1%			≤ ±1%		
Start-up time ⁽⁰²⁾ (Typical)	100 VAC~	520 ms	550 ms	1200 ms	1200 ms	1200 ms	1200 ms
	240 VAC~	530 ms	550 ms	400 ms	400 ms	400 ms	400 ms
Hold time ⁽⁰²⁾ (Typical)	100 VAC~	15 ms	14 ms	15 ms	98 ms	75 ms	87 ms
	240 VAC~	100 ms	110 ms	108 ms	97 ms	43 ms	86 ms
Protection							
Inrush current protection (Typical)	100 VAC~	13 A	14 A	10 A	9 A	11 A	10 A
	240 VAC~	19 A	17 A	37 A	37 A	36 A	37 A
Over-current protection ^{(04) (05)}		105 to 160%			105 to 160%		
Over-voltage protection ⁽⁰⁵⁾		-			16.0 V ±10%	30.0 V ±10%	58.0 V ±10%
Output low-voltage indicate		9.6 V ±10%	20.0 V ±10%	43.0 V ±10%	9.6 V ±10%	20.0 V ±10%	43.0 V ±10%
Power factor correction circuit		-			Built-in		
Approval ⁽⁰⁶⁾		CE  ENEC			CE  ENEC		
Unit weight (Package)		≈ 274 g (≈ 347 g)			≈ 466 g (≈ 570 g)		

Output range		180 to 240 W				
Model		SPB-180-24	SPB-180-48	SPB-240-12	SPB-240-24	SPB-240-48
Output power		180 W	182.4 W	240 W		
Input condition						
Voltage ⁰¹⁾		100 - 240 VAC~ (permissible voltage: 85 - 264 VAC~ / 120 - 370 VDC=)				
Frequency		50 / 60 Hz				
Efficiency ⁰²⁾ (Typical)	100 VAC~	89%	89%	87%	89%	89%
	240 VAC~	92%	92%	90%	92%	92%
Power factor ⁰²⁾		≥ 0.9			≥ 0.9	
Max. current consumption ⁰²⁾		3.0 A			3.8 A	
Current consumption ⁰²⁾ (Typical)	100 VAC~	2.03 A	2.04 A	2.76 A	2.71 A	2.73 A
	240 VAC~	0.83 A	0.84 A	1.14 A	1.12 A	1.13 A
Output characteristics						
Voltage		24 VDC=	48 VDC=	12 VDC=	24 VDC=	48 VDC=
Current		7.5 A	3.8 A	20 A	10 A	5 A
Voltage adjustment range		≤ ±5%			≤ ±5%	
Input variation ⁰³⁾		≤ ±0.5%			≤ ±0.5%	
Load variation		≤ ±1%			≤ ±1%	
Ripple noise ⁰²⁾⁰⁴⁾		≤ ±1%			≤ ±1.5%	≤ ±1%
Start-up time ⁰²⁾ (Typical)	100 VAC~	87 ms	75 ms	75 ms	87 ms	75 ms
	240 VAC~	56 ms	45 ms	45 ms	56 ms	45 ms
Hold time ⁰²⁾ (Typical)	100 VAC~	36 ms	25 ms	33 ms	36 ms	25 ms
	240 VAC~	36 ms	25 ms	33 ms	36 ms	25 ms
Protection						
Inrush current protection (Typical)	100 VAC~	8 A	8 A	8 A	8 A	8 A
	240 VAC~	25 A	26 A	22 A	25 A	26 A
Over-current protection ⁰⁴⁾⁰⁵⁾		105 to 160%			105 to 160%	
Over-voltage protection ⁰⁵⁾		30.0 V ±10%	58.0 V ±10%	16.0 V ±10%	30.0 V ±10%	58.0 V ±10%
Output low-voltage indicate		20.0 V ±10%	43.0 V ±10%	10.0 V ±10%	20.0 V ±10%	43.0 V ±10%
Power factor correction circuit		Built-in			Built-in	
Approval ⁰⁶⁾		CE   			CE   	
Unit weight (Package)		≈ 505 g (≈ 609 g)			≈ 736 g (≈ 866 g)	

01) Since there is no separate input over-voltage protection for the voltage over the rated input voltage range, supplying over-voltage may result in product damage.

02) It is for 100% load condition.

03) It is in the rated input voltage 100-240VAC~ (85-264VAC~) with 100% load.

04) It is for the rated input voltage 100-240VAC~.

05) Refer to the catalog to check the related feature data.

06) It is for AC power input only.

Indicator	Output indicator (green), output low-voltage indicator (red)
Insulation resistance	≥ 100 MΩ (500 VDC= megger, between all input and output terminals)
Dielectric strength	3,000 VAC~ 50/60 Hz for 1 min (between all input and output terminals) 1,500 VAC~ 50/60 Hz for 1 min (between all input terminals and F.G.)
Vibration	10 to 55 Hz (for 1 min) in each X, Y, Z direction for 2 hours
Shock	300 m/s ² (≈ 30G) in each X, Y, Z direction for 3 times
EMS	Conforms to EN61000-6-2
EMI	Conforms to EN61000-6-4
Ambient temperature ⁰¹⁾	-10 to 50 °C, storage: -25 to 65 °C (no freezing or condensation)
Ambient humidity	25 to 85%RH, storage: 25 to 90%RH (no freezing or condensation)
Protection structure	IP20 (IEC standard)

01) UL approved ambient temperature is 40°C, refer to 'Output De-rating Curve by Ambient Temperature'.

DIN-Rail Mount Switching Mode Power Supplies

SP Series



Features

- Compact size
- Built-in overcurrent protection circuit
- DIN rail mount and screw mount methods
- Power supply: 100 - 240 VAC~
- Output voltage: 5 VDC \equiv , 12 VDC \equiv , 24 VDC \equiv
- Output power: 3 W

Specifications

Model	SP-0305	SP-0312	SP-0324
Output power	3 W		
Input condition			
Voltage	100 - 240 VAC~		
Permissible voltage range	85 - 264 VAC~		
Frequency	50 / 60 Hz		
Efficiency (typical)	67 to 74%		
Current consumption (typical)	≤ 0.15 A		
Output characteristics			
Voltage	5 VDC \equiv	12 VDC \equiv	24 VDC \equiv
Current	0.6 A	0.25 A	0.13 A
Voltage adjustment range	$\leq \pm 5\%$		
Ripple noise	$\leq 5\%$		
Voltage variation	$\leq 0.5\%$ (at 85 - 264 VAC~ 100% load)		
Protection			
Over-current protection	$\geq 110\%$		
Approval	ERC		
Unit weight (Package)	≈ 100 g		
Indicator	Output indicator (red)		
Insulation resistance	≥ 100 M Ω (500 VDC \equiv megger)		
Dielectric strength	2,000 VAC~ 50 / 60 Hz for 1 min		
Vibration	0.75 mm amplitude at frequency of 10 to 55 Hz (for 1 min) in each X, Y, Z direction for 2 hours		
Vibration (malfunction)	0.5 mm amplitude at frequency of 10 to 55 Hz (for 1 min) in each X, Y, Z direction for 10 minutes		
Shock	300 m/s ² (≈ 30 G) X, Y, Z direction for 3 times		
Shock (malfunction)	100 m/s ² (≈ 10 G) X, Y, Z direction for 3 times		
Ambient temperature	-10 to 50 °C, storage: -20 to 70 °C (no freezing or condensation)		
Ambient humidity	35 to 85%RH (no freezing or condensation)		

Panel Mount Switching Mode Power Supplies

SPA Series



Features

- Stable power supply with minimal noise and ripple
- Built-in overcurrent protection circuit, output short-circuit protection circuit, overheat protection circuit, and overvoltage protection circuits (overvoltage protection: SPA-075 / 100 only)
- EN 60950 (Safety of information technology equipment) compliant
- EN 50178 (Electronic equipment for use in power installations) compliant
- EN 61000-6-2 (EMC: immunity for industrial environments) compliant
- EN 61000-6-4 (EMC: emission standard for industrial environments) compliant
- Output voltage: 5 VDC \equiv , 12 VDC \equiv , 24 VDC \equiv
- Output power: 30 W, 50 W, 75 W, 100 W

Specifications

Output range	30 to 50 W					
Model	SPA-030-05	SPA-050-05	SPA-030-12	SPA-050-12	SPA-030-24	SPA-050-24
Output power	30 W	50 W	30 W	50 W	30 W	50 W
Input condition						
Voltage ⁰¹⁾	100 - 240 VAC~					
Permissible voltage range	85 - 264 VAC~					
Frequency	50 / 60 Hz					
Efficiency ⁰²⁾ (typical)	≥ 60%	≥ 67%	≥ 74%		≥ 80%	
Current consumption ⁰²⁾ (typical)	≤ 1.2 A	≤ 1.6 A	≤ 1.0 A	≤ 1.4 A	≤ 0.8 A	≤ 1.1 A
Inrush current protection (typical)	100 VAC~	≤ 30 A		≤ 20 A		≤ 20 A
	240 VAC~	≤ 40 A		-		-
Output characteristics						
Voltage	5 VDC \equiv		12 VDC \equiv		24 VDC \equiv	
Current	6 A	10 A	2.5 A	4.2 A	1.5 A	2.1 A
Voltage adjustment range ⁰³⁾	≤ ±5%		≤ ±5%		≤ ±5%	
Input variation ⁰⁴⁾	≤ ±0.5%		≤ ±0.5%		≤ ±0.5%	
Load variation ⁰²⁾	≤ ±2%		≤ ±1%		≤ ±1%	
Ripple noise ⁰²⁾	≤ ±1%		≤ ±1%		≤ ±1%	
Start-up time ⁰²⁾ (typical)	≤ 200 ms		≤ 150 ms		≤ 150 ms	
Hold time ⁰²⁾ (typical)	≥ 10 ms		≥ 10 ms		≥ 10 ms	
Protection						
Over-current protection ⁰⁵⁾	≥ 110%		≥ 110%		≥ 110%	
Over-voltage protection ⁰³⁾	-		-		-	
Output short-circuit protection	≤ 5 ms		≤ 5 ms		≤ 5 ms	
Approval	CE ENEC		CE ENEC		CE ENEC	
Unit weight	≈ 350 g		≈ 350 g		≈ 350 g	

Output range	75 to 100 W					
Model	SPA-075-05	SPA-100-05	SPA-075-12	SPA-100-12	SPA-075-24	SPA-100-24
Output power	75 W	100 W	75 W	100 W	75 W	100 W
Input condition						
Voltage ⁰¹⁾	100 - 120 / 200 - 240 VAC~ (permissible voltage: 85 - 264 VAC~) switching type					
Frequency	50 / 60 Hz					
Efficiency ⁰²⁾ (typical)	≥ 70%		≥ 78%	≥ 72%	≥ 78%	≥ 80%
Current consumption ⁰²⁾ (typical)	≤ 3.0 A		≤ 2.0 A	≤ 3.0 A	≤ 2.0 A	≤ 2.5 A
Inrush current protection (typical)	100 VAC~	≤ 45 A	≤ 35 A	≤ 45 A	≤ 35 A	
	240 VAC~	≤ 50 A	≤ 40 A	≤ 50 A	≤ 40 A	
Output characteristics						
Voltage	5 VDC≡		12 VDC≡		24 VDC≡	
Current	15 A	20 A	6.3 A	8.5 A	3.2 A	4.2 A
Voltage adjustment range ⁰³⁾	≤ ±5%		≤ ±5%		≤ ±5%	
Input variation ⁰⁴⁾	≤ ±0.5%		≤ ±0.5%		≤ ±0.5%	
Load variation ⁰²⁾	≤ ±2%		≤ ±1%		≤ ±1%	
Ripple noise ⁰²⁾	≤ ±1%		≤ ±1%		≤ ±1%	
Start-up time ⁰²⁾ (typical)	≤ 250 ms		≤ 250 ms		≤ 250 ms	
Hold time ⁰²⁾ (typical)	≥ 5 ms		≥ 10 ms	≥ 5 ms	≥ 10 ms	
Protection						
Over-current protection ⁰⁵⁾	≥ 110%	≥ 105%	≥ 110%		≥ 110%	
Over-voltage protection ⁰³⁾	6.5 V ±10%		16.0 V ±10%		30.0 V ±10%	
Output short-circuit protection	≤ 10 ms		≤ 5 ms	≤ 10 ms	≤ 5 ms	
Approval	CE EAC		CE EAC		CE EAC	
Unit weight	≈ 400 g		≈ 400 g		≈ 400 g	
Indicator	Output indicator (green)					
Insulation resistance	≥ 100 MΩ (500 VDC≡ megger, between all inputs and outputs)					
Dielectric strength	3,000 VAC~ 50/60 Hz for 1 min (between all inputs and outputs) 1,500 VAC~ 50/60 Hz for 1 min (between all inputs and F.G.)					
Vibration	10 to 55 Hz (for 1 min) amplitude at frequency 0.75 mm in each X, Y, Z direction for 2 hours					
Shock	300 m/s ² (≈ 30 G) in each X, Y, Z direction for 3 times					
EMS	EN61000-6-2 conformation					
EMI	EN61000-6-4 conformation					
Safety standards	EN60950, EN50178					
Ambient temperature	-10 to 50 °C (SPA-050-05, SPA-030-12, SPA-050-12: -10 to 40 °C), storage: -25 to 65 °C (no freezing or condensation)					
Ambient humidity	25 to 85%RH, storage: 25 to 90%RH (no freezing or condensation)					

01) Since there is no separate input over-voltage protection for the voltage over the rated input voltage range, Supplying over-voltage may result in product damage.

02) It is in the rated input voltage 100 VAC~ with 100% load.

03) Use the output voltage adjusting volume within the voltage variable range. If the voltage exceeds the output voltage range, overvoltage protection function is activated and the output is cut off.

04) Rate input voltage

SPA-030 / 050 series: 100 - 240 VAC~ (85 - 264 VACT) with 100% of load

SPA-075 / 100 series: 100 - 120 / 200 - 240 (85 - 132 / 170 - 264 VAC~) with 100% of load

SPA-100-05 model: 100 - 120 / 200 - 240 VAC~ (100 - 132 / 190 - 264 VAC~) with 100% of load

05) It is for rate input voltage 100 VAC~.

Panel Mount Switching Mode Power Supplies

SPA-400-24 Series



Features

- Built-in over-current protection circuit, output short-circuit protection circuit, and over-voltage protection circuit
- EN 60950 (Safety of information technology equipment) compliant
- EN 50178 (Electronic equipment for use in power installations) compliant
- EN 61000-6-2 (EMC: immunity for industrial environments) compliant
- EN 61000-6-4 (EMC: emission standard for industrial environments) compliant
- Output voltage: 24 VDC \equiv
- Output power: 400 W

Specifications

Model	SPA-400-24
Output power	400.8 W
Input condition	
Voltage ⁰¹⁾	200 - 240 VAC~ (permissible voltage: 190 - 264 VAC~)
Frequency	50 / 60 Hz
Efficiency ⁰²⁾ (typical)	≥ 85% (10 min after power ON)
Current consumption ⁰²⁾ (typical)	≤ 4.6 A
Leakage current ⁰²⁾ (typical)	≤ 1 mA
Inrush current protection ⁰²⁾ (typical)	40 A
Output characteristics	
Voltage	24 VDC \equiv
Current	16.7 A
Voltage adjustment range ⁰³⁾	≤ ±5%
Input variation	≤ ±0.5%
Load variation	≤ ±1%
Temperature drift	360 mV
Ripple noise	≤ 290 mV
Start-up time ⁰²⁾ (typical)	1,800 to 2,300 ms
Hold time ⁰²⁾ (typical)	≥ 17 ms
Protection	
Over-current protection	110 to 160% (recovers automatically after the cause for over current is removed)
Over-voltage protection ⁰³⁾	27 - 33 VDC \equiv
Temperature rising limit	Yes
Remote control	Yes (output voltage ON for shorting, output voltage OFF for open)
Product Components	• Product • Instruction manual
Approval	CE
Unit weight (package)	≈ 885 g (= 975 g)
Indicator	Output indicator (green)
Insulation resistance	≥ 100 MΩ (at 500VDC \equiv megger, between all input terminals and F.G.)
Dielectric strength	3,000 VAC~ 50/60 Hz for 1 min (between all input and output terminals) 2,000 VAC~ 50/60 Hz for 1 min (between all input terminals and F.G.)
Vibration	0.75 mm amplitude at frequency of 10 to 55Hz (for 1 min) in each X, Y, Z direction for 2 hours
EMS	EN61000-6-2 compliant
EMI	EN61000-6-4 compliant
Safety standards	EN60950, EN50178
Ambient temperature	-10 to 50 °C, storage: -20 to 75 °C (no freezing or condensation)
Ambient humidity	20 to 90%RH, storage: 20 to 90%RH (no freezing or condensation)
Fan life cycle	70,000 hours (based on 40 °C of ambient temperature)

01) Since there is no separate input overvoltage protection for the voltage over the rated input voltage range, supplying overvoltage may result in product damage.

02) It is for 220 VAC~, 100% load.

03) Use the output voltage adjusting volume within the voltage variable range. If the voltage exceeds the output voltage range, overvoltage protection function is activated and the output is cut off.



F2. SSR

Solid state relays (SSR) are highly durable and reliable electronics switching devices which are ideal alternatives for mechanical relays.

F2-1	Single-Phase / Integrated Heatsink	SRH1 Series	Single-Phase Top / Bottom Terminal SSR with Integrated Heatsink (Current Input Type)
			Single-Phase Top / Bottom Terminal SSR with Integrated Heatsink (Voltage Input Type)
F2-2	Single-Phase / Detachable Heatsink	SRHL1 Series	Single-Phase Right / Left Terminal SSR with Integrated Heatsink
		SR1 Series	Single-Phase SSR with Detachable Heatsink
		SRC1 Series	Single-Phase Slim SSR with Detachable Heatsink
		SRS1 Series	Single-Phase Socket SSR with Detachable Heatsink
F2-3	Three-Phase / Detachable Heatsink	SR2 / SR3 / SRH2 / SRH3 Series	2 / 3-Phase SSR with Detachable / Integrated Heatsink

Single-Phase Top / Bottom Terminal

SSR with Integrated Heatsink

(Current Input Type)

SRH1 Series



Features

- High heat dissipation efficiency with ceramic PCB and integrated heatsink
- Input Indicator (green)
- DIN rail mount or panel mount installation
- Phase control (power equality division / phase equality division), cycle control (fixed cycle/variable cycle)
- Improved dielectric strength: 4,000 VAC~

Specifications

[Input]

Rated input current	4 - 20 mA
Allowable input voltage range	50 mA
Pick-up current	≥ 4.2 mA
Static off current	≤ 4.0 mA
Power factor	≥ 0.9 (difference between voltage phase and current phase: ≤ 25 °)
Start-up time	60 Hz: 200 ms / 50 Hz: 250 ms
Operating time	60 Hz: 16.6 ms / 50 Hz: 20 ms
Operating mode ⁰¹⁾	Phase control (power equality division type / phase equality division type) Cycle control(variable cycle / fixed cycle)

⁰¹⁾ You can change operation mode by jumper pin. Default is Phase control (power equality division type).
For more information, see the 'Operation Mode.'

[Output]

Rated load voltage range	100 - 240 VACrms~ (50 / 60 Hz)			200 - 480 VACrms~ (50 / 60 Hz)			
Allowable load voltage range	90 - 264 VACrms~ (50 / 60 Hz)			200 - 528 VACrms~ (50 / 60 Hz)			
Rated load current	Resistive load (AC-51) ⁰¹⁾	20 Arms	30 Arms	60 Arms	20 Arms	30 Arms	60 Arms
Min. load current	0.5 Arms			0.5 Arms			
Max. 1 cycle surge current (60 Hz)	300 A	500 A	1000 A	300 A	500 A	1000 A	
Max. non-repetitive surge current (I ² t, t = 8.3 ms)	350 A ² s	1000 A ² s	4000 A ² s	350 A ² s	1000 A ² s	4000 A ² s	
Peak voltage (non-repetitive)	600 V			1000 V			
Leakage current (Ta = 25 °C)	≤ 10 mArms (240 VAC~/ 60 Hz)			≤ 10 mArms (480 VAC~/ 60 Hz)			
Output ON voltage drop [Vpk] (max. load current)	≤ 1.6 V						
Static off state dv/dt	500 V/μs						

⁰¹⁾ AC-51 is utilization category at IEC60947-4-3.

[General specifications]

Output range (phase control)	0 - 99 %
Frequency reading function	YES
Dielectric strength (Vrms)	Input-output, input/output-case : 4000 VAC~ 50 / 60 Hz for 1 min
Insulation resistance	≥ 100 MΩ (500 VDC≡ megger)
Indicator	Input indicator (green)
Vibration	0.75 mm double amplitude at frequency of 10 to 55 Hz (for 1 min) in each X, Y, Z direction for 1 hour
Ambient temperature ⁰¹⁾	-20 to 70 °C, storage: -20 to 100 °C (no freezing or condensation)
Ambient humidity	45 to 85 %RH, storage: 45 to 85 %RH (no freezing or condensation)
Input terminal connection	≥ 1×0.5 mm ² (1×AWG 20), ≤ 1×16 mm ² (1×AWG 6) or ≤ 2×1.5 mm ² (2×AWG 16)
Output terminal connection ⁰²⁾	≥ 1×1.5 mm ² (1×AWG 16), ≤ 1×16 mm ² (1×AWG 6) or ≤ 2×6 mm ² (2×AWG 10)
Input terminal fixed torque	0.75 to 0.95 N m
Output terminal fixed torque	1.6 to 2.2 N m
Approval	CE  ENEC
Weight	Rated load current 20 / 30 A: ≈ 410 g Rated load current 60 A: ≈ 680 g

01) See the 'SSR Derating Curve' in the product manual because the capacity of the rated load current is differ depending on the ambient temperature.

02) Connect the wire met the capacity of the load current to the output terminal.

Single-Phase Top / Bottom Terminal

SSR with Integrated Heatsink

(Voltage Input Type)

SRH1 Series



Features

- High heat dissipation efficiency with ceramic PCB and integrated heatsink
- Input Indicator (green)
- DIN rail mount or panel mount installation
- Zero cross turn-on / Random turn-on models available

Specifications

[Input]

Rated input voltage range	4 - 30 VDC \equiv	24 VACrms \sim (50 / 60 Hz)	90 - 240 VACrms \sim (50 / 60 Hz)
Allowable input voltage range	4 - 32 VDC \equiv	19 - 30 VACrms \sim (50 / 60 Hz)	85 - 264 VACrms \sim (50 / 60 Hz)
Max. input current	18 mA	15 mArms (24 VACrms \sim)	18 mArms (240 VACrms \sim)
Operating voltage	≥ 4 VDC \equiv	≥ 19 VACrms \sim	≥ 85 VACrms \sim
Releasing voltage	≤ 1 VDC \equiv	≤ 4 VACrms \sim	≤ 10 VACrms \sim
Operating time	Zero cross turn-on	≤ 0.5 cycle of load power + 1 ms	≤ 2 cycle of load power + 1 ms
	Random turn-on	≤ 1 ms	-
Releasing time	≤ 0.5 cycle of load power + 1 ms	≤ 2 cycle of load power + 1 ms	≤ 2 cycle of load power + 1 ms

[Output]

Rated load voltage range	24 - 240 VACrms \sim (50 / 60 Hz)						
Allowable load voltage range	24 - 264 VACrms \sim (50 / 60 Hz)						
Rated load current	Resistive load (AC-51) ^{①)}	10 Arms	15 Arms	20 Arms	30 Arms	40 Arms	60 Arms
	Min. load current	0.15 Arms	0.15 Arms	0.2 Arms	0.5 Arms	0.5 Arms	0.5 Arms
Max. 1 cycle surge current(60 Hz)	160 A	160 A	250 A	400 A	500 A	1000 A	
Max. non-repetitive surge current (I ² t, t = 8.3 ms)	130 A ² s	130 A ² s	300 A ² s	910 A ² s	1000 A ² s	4000 A ² s	
Peak voltage (non-repetitive)	600 V						
Leakage current (Ta = 25 °C)	≤ 10 mArms (240 VAC \sim /60 Hz)						
Output ON voltage drop [Vpk](max. load current)	≤ 1.6 V						
Static off state dv/dt	500 V/ μ s						

Rated load voltage range	48 - 480 VACrms~(50 / 60 Hz)						
Allowable load voltage range	48 - 528 VACrms~ (50 / 60 Hz)						
Rated load current	Resistive load (AC-51) ⁰¹⁾	10 Arms	15 Arms	20 Arms	30 Arms	40 Arms	60 Arms
Min. load current		0.5 Arms	0.5 Arms	0.5 Arms	0.5 Arms	0.5 Arms	0.5 Arms
Max. 1 cycle surge current(60 Hz)		300 A	300 A	300 A	500 A	500 A	1000 A
Max. non-repetitive surge current (I²t, t = 8.3 ms)		350 A ² s	350 A ² s	350 A ² s	1000 A ² s	1000 A ² s	4000 A ² s
Peak voltage (non-repetitive)		1200 V (Zero cross turn-on), 1000 V (Random turn-on)					
Leakage current (Ta = 25 °C)		≤ 10 mArms (480 VAC~/60 Hz)					
Output ON voltage drop [Vpk](max. load current)		≤ 1.6 V					
Static off state dv/dt		500 V/μs					

01) AC-51 is utilization category at IEC60947-4-3.

[General specifications]

Dielectric strength (Vrms)	Input-output, input/output-case : 2500 VAC~ 50 / 60 Hz for 1 min
Insulation resistance	Input-output, input/output-case : ≥ 100 MΩ (500 VDC≡ megger)
Indicator	Input indicator (green)
Vibration	0.75 mm double amplitude at frequency of 10 to 55 Hz (for 1 min) in each X, Y, Z direction for 1 hour
Vibration (malfunction)	0.5 mm double amplitude at frequency of 10 to 55 Hz (for 1 min) in each X, Y, Z direction for 10 min
Shock	300 m/s ² (≈ 30 G) in each X, Y, Z direction for 3 times
Shock (malfunction)	100 m/s ² (≈ 10 G) in each X, Y, Z direction for 3 times
Ambient temperature⁰¹⁾	-30 to 80 °C (in case of the rated input voltage 90 - 240 VAC~: -20 to 70 °C), storage: -30 to 100 °C (no freezing or no condensation)
Ambient humidity	45 to 85 %RH, storage: 45 to 85 %RH (no freezing or no condensation)
Input terminal connection	≥ 1×0.5 mm ² (1×AWG 20), ≤ 1×1.5 mm ² (1×AWG 16) or ≤ 2×1.5 mm ² (2×AWG 16)
Output terminal connection⁰²⁾	Rated load current 10 / 15 / 20 A : ≥ 1×0.75 mm ² (1×AWG 18), ≤ 1×4 mm ² (1×AWG 12) or ≤ 2×2.5 mm ² (2×AWG 14) Rated load current 30 / 40 / 60 A : ≥ 1×1.5 mm ² (1×AWG 16), ≤ 1×16 mm ² (1×AWG 6) or ≤ 2×6 mm ² (2×AWG 10)
Input terminal fixed torque	0.75 to 0.95 N m
Output terminal fixed torque	Rated load current 10 / 15 / 20 A: 1.0 to 1.35 N m Rated load current 30 / 40 / 60 A: 1.6 to 2.2 N m
Approval	CE, RoHS, ENEC
Weight (packaged)	Rated load current 10 / 15 / 20 A: ≈ 225 g (≈ 298 g) Rated load current 30 / 40 A: ≈ 410 g (≈ 500 g) Rated load current 60 A: ≈ 680 g (≈ 770 g)

01) See the 'SSR Derating Curve' in the product manual because the capacity of the rated load current is differ depending on the ambient temperature.

02) Connect the wire met the capacity of the load current to the output terminal.

Single-Phase Right / Left Terminal SSR with Integrated Heatsink

SRHL1 Series



Features

- Rated input voltage: 10 - 30 VDC \equiv , 90 - 240 VAC \sim
- Rated load voltage: 24 - 240 VAC \sim , 48 - 480 VAC \sim
- Rated load current: 10 A, 15 A, 20 A, 25 A, 40 A
- Zero cross turn-on / Random turn-on models available
- Input indicator (green)
- Overheat prevention function
 - Rated load current 10 / 15 / 20 / 25 A: alarm indicator (red)
 - Rated load current 40 A: alarm output indicator (red), alarm output
- DIN Rail or panel mount installation

Specifications

[Input]

Rated input voltage range	10 - 30 VDC \equiv	90 - 240 VACrms \sim (50 / 60 Hz)
Allowable input voltage range	9 - 32 VDC \equiv	85 - 264 VACrms \sim (50 / 60 Hz)
Max. input current	15 mA	22 mA
Operating voltage	\geq 9 VDC \equiv	\geq 85 VACrms \sim
Releasing voltage	\leq 1 VDC \equiv	\leq 10 VACrms \sim
Operating time	Zero cross turn-on	\leq 0.5 cycle of load power + 1 ms
	Random turn-on	\leq 1 ms
Releasing time	\leq 0.5 cycle of load power + 1 ms	\leq 2 cycle of load power + 1 ms

[Output]

Rated load voltage range	24 - 240 VACrms \sim (50 / 60 Hz)					
Allowable load voltage range	24 - 264 VACrms \sim (50 / 60 Hz)					
Rated load current	Resistive load (AC-51) ⁰¹⁾	10 Arms	15 Arms	20 Arms	25 Arms	40 Arms
Min. load current		0.15 Arms	0.15 Arms	0.2 Arms	0.2 Arms	0.5 Arms
Max. 1 cycle surge current(60 Hz)		160 A	160 A	250 A	250 A	400 A
Max. non-repetitive surge current (I ² t, t = 8.3 ms)		130 A ² s	130 A ² s	300 A ² s	300 A ² s	910 A ² s
Peak voltage (non-repetitive)		600 V				
Leakage current (Ta = 25 °C)		\leq 10 mA (240 VAC \sim /60 Hz)				
Output ON voltage drop [Vpk](max. load current)		\leq 1.6 V				
Static off state dv/dt		500 V/ μ s				

Rated load voltage range		48 - 480 VACrms~ (50 / 60 Hz)				
Allowable load voltage range		48 - 528 VACrms~ (50 / 60 Hz)				
Rated load current	Resistive load (AC-51) ⁰¹⁾	10 Arms	15 Arms	20 Arms	25 Arms	40 Arms
Min. load current		0.5 Arms				
Max. 1 cycle surge current (60 Hz)		300 A	300 A	500 A	500 A	500 A
Max. non-repetitive surge current (I²t, t = 8.3 ms)		350 A ² s	350 A ² s	1000 A ² s	1000 A ² s	1000 A ² s
Peak voltage (non-repetitive)		1200 V (zero cross turn-on), 1000 A (random turn-on)				
Leakage current (Ta = 25 °C)		≤ 10 mArms (480 VAC~/60 Hz)				
Output ON voltage drop [Vpk] (max. load current)		≤ 1.6 V				
Static off state dv/dt		500 V/μs				

01) AC-51 is utilization category at IEC60947-4-3.

[Overheat prevention function]

Overheat prevention function is when SSR internal temperature is overheated, the load output is cut off to prevent internal device damage and also the alarm indicator and alarm output turn ON. The operating temperature of the overheat prevention function may vary depending on the external environment, product configuration, and load current.

Rated input voltage range	10 - 30 VDC==	90 - 240 VACrms~ (50 / 60 Hz)
Load voltage	≤ 30 VDC==	≤ 30 VDC==
Load current	≤ 50 mA	≤ 50 mA
Turn-off time	≤ 50 ms	≤ 100 ms

• Alarm output is only for the rated load current 40 A model, in case of the rated load current 10 / 15 / 20 / 25 A model, the alarm indicator turns ON without the alarm output.

• To clear alarm, cut off the input signal during over the alarm output return time at the rated ambient temperature.

[General specifications]

Dielectric strength (Vrms)	Input-output: 2500 VAC~ 50 / 60 Hz for 1 min Input / output-case: 4000 VAC~ 50 / 60 Hz for 1 min
Insulation resistance	Input-output, input/output-case: ≥ 100 MΩ (500 VDC== megger)
Indicator	Input indicator (green), alarm indicator (red)
Vibration	0.75 mm double amplitude at frequency of 10 to 55 Hz (for 1 min) in each X, Y, Z direction for 1 hour
Vibration (malfunction)	0.5 mm double amplitude at frequency of 10 to 55 Hz (for 1 min) in each X, Y, Z direction for 10 min
Shock	300 m/s ² (≈ 30 G) in each X, Y, Z direction for 3 times
Shock (malfunction)	100 m/s ² (≈ 10 G) in each X, Y, Z direction for 3 times
Ambient temperature⁰¹⁾	-30 to 70 °C, storage: -30 to 100 °C (no freezing or condensation)
Ambient humidity	45 to 85 %RH, storage: 45 to 85 %RH (no freezing or condensation)
Input terminal connection	≥ 1×0.5 mm ² (1×AWG 20), ≤ 1×4 mm ² (1×AWG 12) or ≤ 2×1.5 mm ² (2×AWG 16)
Output terminal connection⁰²⁾	Rated load current 10 / 15 / 20 / 25 A : ≥ 1×0.75 mm ² (1×AWG 18), ≤ 1×6 mm ² (1×AWG 10) or ≤ 2×2.5 mm ² (2×AWG 14) Rated load current 40 A : ≥ 1×1.5 mm ² (1×AWG 16), ≤ 1×16 mm ² (1×AWG 6) or ≤ 2×6 mm ² (2×AWG 10)
Input terminal fixed torque	0.75 to 0.95 N m
Output terminal fixed torque	Rated load current 10 / 15 / 20 / 25 A: 1.0 to 1.35 N m Rated load current 40 A: 1.6 to 2.2 N m
Approval	CE   
Weight (packaged)	Rated load current 10 / 15 / 20 / 25 A: ≈ 192 g (≈ 270 g) Rated load current 40 A: ≈ 372 g (≈ 468 g)

01) See the 'SSR Derating Curve' because the capacity of the rated load current is differ depending on the ambient temperature.
02) Connect the wire met the capacity of the load current to the output terminal.

Single-Phase

SSR with
Detachable
Heatsink

SR1 Series



Features

- Compact, universal design for flexible installation
- High heat dissipation efficiency with ceramic PCB
- Zero cross turn-on, random turn-on models available
- Input Indicator (green)

Specifications

[Input]

Rated input voltage range	4 - 30 VDC $\overline{=}$	90 - 240 VACrms \sim (50 / 60 Hz)
Allowable input voltage range	4 - 32 VDC $\overline{=}$	85 - 264 VACrms \sim (50 / 60 Hz)
Max. input current	18 mA	18 mArms (240 VACrms \sim)
Operating voltage	\geq 4 VDC $\overline{=}$	\geq 85 VACrms \sim
Releasing voltage	\leq 1 VDC $\overline{=}$	\leq 10 VACrms \sim
Operating time	Zero cross turn-on	\leq 0.5 cycle of load power + 1 ms
	Random turn-on	\leq 1 ms
Releasing time	\leq 0.5 cycle of load power + 1 ms	\leq 2 cycle of load power + 1 ms

[Output]

Rated load voltage range	24 - 240 VACrms \sim (50 / 60 Hz)								
Allowable load voltage range	24 - 264 VACrms \sim (50 / 60 Hz)								
Rated load current	Resistive load (AC-51) ⁰¹⁾	10 Arms	15 Arms	20 Arms	25 Arms	30 Arms	40 Arms	50 Arms	75 Arms
	Min. load current	0.15 Arms		0.2 Arms		0.2 Arms		0.5 Arms	
Max. 1 cycle surge current(60 Hz)	160 A		250 A		400 A		1000 A		
Max. non-repetitive surge current (I ² t, t = 8.3 ms)	130 A ² s		300 A ² s		910 A ² s		4000 A ² s		
Peak voltage (non-repetitive)	600 V								
Leakage current (Ta = 25 °C)	\leq 10 mArms (240 VAC \sim /60 Hz)								
Output ON voltage drop [Vpk] (max. load current)	\leq 1.6 V								
Static off state dv/dt	500 V/ μ s								

Rated load voltage range		48 - 480 VACrms~(50 / 60 Hz)							
Allowable load voltage range		48 - 528 VACrms~ (50 / 60 Hz)							
Rated load current	Resistive load (AC-51) ⁰¹⁾	10 Arms	15 Arms	20 Arms	25 Arms	30 Arms	40 Arms	50 Arms	75 Arms
Min. load current		0.5 Arms		0.5 Arms		0.5 Arms		0.5 Arms	
Max. 1 cycle surge current (60 Hz)		300 A		500 A		500 A		1000 A	
Max. non-repetitive surge current (I²t, t = 8.3 ms)		350 A ² s		1000 A ² s		1000 A ² s		4000 A ² s	
Peak voltage (non-repetitive)		1200 V (zero cross turn-on), 1000 V (random turn-on)							
Leakage current (Ta = 25 °C)		≤ 10 mA Arms (480 VAC~/ 60 Hz)							
Output ON voltage drop[Vpk] (max. load current)		≤ 1.6 V							
Static off state dv / dt		500 V/μs							

01) AC-51 is utilization category at IEC60947-4-3.

[General specifications]

Dielectric strength (Vrms)	Input-output, input / output-case : 2500 VAC~ 50 / 60 Hz for 1 min
Insulation resistance	Input-output, input / output-case : ≥ 100 MΩ (500 VDC== megger)
Indicator	Input indicator (green)
Vibration	0.75 mm double amplitude at frequency of 10 to 55 Hz (for 1 min) in each X, Y, Z direction for 1 hour
Vibration (malfunction)	0.5 mm double amplitude at frequency of 10 to 55 Hz (for 1 min) in each X, Y, Z direction for 10 min
Shock	300 m/s ² (≈ 30 G) in each X, Y, Z direction for 3 times
Shock (malfunction)	100 m/s ² (≈ 10 G) in each X, Y, Z direction for 3 times
Ambient temperature⁰¹⁾	-30 to 80 °C (in case of the rated input voltage 90 - 240 VAC~: -20 to 70 °C), storage: -30 to 100 °C (no freezing or condensation)
Ambient humidity	45 to 85 %RH, storage: 45 to 85 %RH (no freezing or condensation)
Input terminal connection	≥ 1×0.5 mm ² (1×AWG 20), ≤ 1×1.5 mm ² (1×AWG 16) or ≤ 2×1.5 mm ² (2×AWG 16)
Output terminal connection⁰²⁾	≥ 1×1.5 mm ² (1×AWG 16), ≤ 1×16 mm ² (1×AWG 6) or ≤ 2×6 mm ² (2×AWG 10)
Input terminal fixed torque	0.75 to 0.95 N m
Output terminal fixed torque	1.6 to 2.2 N m
Approval	CE, RoHS, ENEC
Weight (packaged)	≈ 73 g (≈ 111g)

01) Please refer to Autonics website.

02) Connect the wire met the capacity of the load current to the output terminal.

Single-Phase Slim

SSR with
Detachable
Heatsink

SRC1 Series



Features

- Slim, compact size (22.5 mm width)
- High heat dissipation efficiency with ceramic PCB
- Zero cross turn-on, random turn-on models available
- Input Indicator (green)

Specifications

[Input]

Rated input voltage range	4 - 30 VDC \equiv	90 - 240 VACrms \sim (50 / 60 Hz)
Allowable input voltage range	4 - 32 VDC \equiv	85 - 264 VACrms \sim (50 / 60 Hz)
Max. input current	18 mA	18 mArms (240 VACrms \sim)
Operating voltage	\geq 4 VDC \equiv	\geq 85 VACrms \sim
Releasing voltage	\leq 1 VDC \equiv	\leq 10 VACrms \sim
Operating time	Zero cross turn-on	\leq 0.5 cycle of load power + 1 ms
	Random turn-on	\leq 1 ms
Releasing time	\leq 0.5 cycle of load power + 1 ms	\leq 2 cycle of load power + 1 ms

[Output]

Rated load voltage range	24 - 240 VACrms \sim (50 / 60 Hz)			
Allowable load voltage range	24 - 264 VACrms \sim (50 / 60 Hz)			
Rated load current	Resistive load (AC-51) ⁰¹⁾	10 Arms	15 Arms	20 Arms
	Min. load current	0.15 Arms	0.2 Arms	0.5 Arms
Max. 1 cycle surge current (60 Hz)	160 A	250 A	300 A	
Max. non-repetitive surge current (I ² t, t = 8.3 ms)	130 A ² s	300 A ² s	350 A ² s	
Peak voltage (non-repetitive)	600 V			
Leakage current (Ta = 25 °C)	\leq 10 mArms (240 VAC \sim /60 Hz)			
Output ON voltage drop [Vpk](Max. load current)	\leq 1.6 V			
Static off state dv / dt	500 V/ μ s			

Rated load voltage range	48 - 480 VACrms~ (50 / 60 Hz)	
Allowable load voltage range	48 - 528 VACrms~ (50 / 60 Hz)	
Rated load current	Resistive load (AC-51) ⁰¹⁾	20 Arms
Min. load current	0.5 Arms	
Max. 1 cycle surge current (60 Hz)	300 A	
Max. non-repetitive surge current (I²t, t = 8.3 ms)	350 A ² s	
Peak voltage (non-repetitive)	1200 V (zero cross turn-on), 1000 V (random turn-on)	
Leakage current (Ta = 25 °C)	≤ 10 mArms (480 VAC~/60 Hz)	
Output ON voltage drop [Vpk] (Max. load current)	≤ 1.6 V	
Static off state dv/dt	500V/μs	

01) AC-51 is utilization category at IEC60947-4-3.

[General specifications]

Dielectric strength (Vrms)	Input-output, input / output-case : 2500 VAC~ 50 / 60 Hz for 1 min
Insulation resistance	Input-output, input / output-case : ≥ 100 MΩ (500 VDC= megger)
Indicator	Input indicator (green)
Vibration	0.75 mm double amplitude at frequency of 10 to 55 Hz (for 1 min) in each X, Y, Z direction for 1 hour
Vibration (malfunction)	0.5 mm double amplitude at frequency of 10 to 55 Hz (for 1 min) in each X, Y, Z direction for 10 min
Shock	300 m/s ² (≈ 30 G) in each X, Y, Z direction for 3 times
Shock (malfunction)	100 m/s ² (≈ 10 G) in each X, Y, Z direction for 3 times
Ambient temperature⁰¹⁾	-30 to 80 °C (in case of the rated input voltage 90 - 240 VAC~: -20 to 70 °C), storage: -30 to 100 °C (no freezing or condensation)
Ambient humidity	45 to 85 %RH, storage: 45 to 85 %RH (no freezing or condensation)
Input terminal connection	≥ 1×0.5 mm ² (1×AWG 20), ≤ 1×1.5 mm ² (1×AWG 16) or ≤ 2×1.5 mm ² (2×AWG 16)
Output terminal connection⁰²⁾	≥ 1×0.75 mm ² (1×AWG 16), ≤ 1×4 mm ² (1×AWG 12) or ≤ 2×2.5 mm ² (2×AWG 14)
Input terminal fixed torque	0.75 to 0.95 N m
Output terminal fixed torque	1.0 to 1.35 N m
Approval	CE cULus ENEC
Weight (packaged)	≈ 85 g (≈ 119 g)

01) See the 'SSR Derating Curve' because the capacity of the rated load current is differ depending on the ambient temperature.
02) Connect the wire met the capacity of the load current to the output terminal.

Single-Phase Socket

SSR with
Detachable
Heatsink

SRS1 Series



Features

- Dielectric strength : 2,500 VAC~
- Rated input voltage
 - SRS1-A: AC, DC, AC / DC
 - SRS1-B: AC
 - SRS1-C: AC, DC, AC / DC
- Socket type for easier installation and maintenance
 - SRS1-A: Autonics SK-G05 sockets
 - SRS1-B: General LY2 sockets
 - SRS1-C: General MY4 sockets
- Zero cross turn-on, random turn-on models available
- Input indicator (red)

Specifications

[Input]

Model	SRS1-A	SRS1-B	SRS1-C120 □	SRS1-C1 □
Rated input voltage range	4 - 24 VDC≡	4 - 30 VDC≡	4 - 30 VDC≡	4 - 24 VDC≡
Allowable input voltage range	4 - 26.4 VDC≡	4 - 32 VDC≡	4 - 32 VDC≡	4 - 26.4 VDC≡
Max. input current	15 mA (Random turn-on)	13 mA (Random turn-on)	13 mA (Random turn-on)	15 mA
Operating voltage	≥ 4 VDC≡			
Releasing voltage	≤ 1 VDC≡			

[Output (AC load)]

Model	SRS1-A			SRS1-B / SRS1-C		
	1202(R)	1203(R)	1205(R)	1202(R)-2	1203(R)-1	1205(R)-1
Rated input load range	24 - 240 VACrms~ (50 / 60 Hz)			90 - 240 VACrms~ (50 / 60 Hz)		
Allowable input load range	24 - 264 VACrms~ (50 / 60 Hz)			90 - 264 VACrms~ (50 / 60 Hz)		
Rated load current Resistive load (AC-51 ⁰¹⁾)	2 Arms	3 Arms	5 Arms	2 Arms	3 Arms	5 Arms
Min. load current	0.15 Arms	0.2 Arms		0.15 Arms		
Max. 1 cycle surge current (60 Hz)	126 A	250 A		126 A		250 A
Max. non-repetitive surge current (I ² t, t = 8.3 ms)	65 A ² s	400 A ² s		65 A ² s		220 A ² s
Peak voltage (non-repetitive)	600 V					
Leakage current (Ta = 25 °C)	≤ 2 mArms (240 VAC~ 50/60 Hz)					
Output ON voltage drop [Vpk] (Max. load current)	≤ 1.6 V					
Static off state dv/dt	500 V/μs					
Operating time	Zero cross turn-on: ≤ 0.5 cycle of load power + 1 ms Random turn-on: ≤ 1 ms					
Releasing time	≤ 0.5 cycle of load power + 1 ms					

01) AC-51 is utilization category at IEC60947-4-3.

[Output (DC load)]

Model	SRS1-A1D101	SRS1-A1D102	SRS1-A1D201	SRS1-C1D102-1
Rated input load range	5 - 100 VDC \equiv		5 - 200 VDC \equiv	5 - 100 VDC \equiv
Allowable input load range	3 - 120 VDC \equiv		3 - 220 VDC \equiv	3 - 120 VDC \equiv
Rated load current	1 Adc	2 Adc	1 Adc	2 Adc
Resistive load (AC-51 ⁰¹⁾)				
Min. load current	10 mA			
Max. surge current (t=10 ms)	5 A	10 A	4 A	10 A
Leakage current (Ta = 25 °C)	\leq 100 μ A			
Output ON voltage drop [Vpk] (Max. load current)	\leq 1.1 V			
Static off state dv/dt	500 V/ μ s			-
Operating time	\leq 1 ms	\leq 2 ms	\leq 1 ms	\leq 1 ms
Releasing time	\leq 1 ms			

01) AC-51 is utilization category at IEC60947-4-3.

[Output (AC / DC load)]

Model	SRS1-A1X201	SRS1-C1X201-1
Rated input load range	5 - 240 VACrms \sim (50 / 60 Hz) / 5 - 200 VDC \equiv	
Allowable input load range	3 - 264 VACrms \sim (50 / 60 Hz) / 3 - 220 VDC \equiv	
Rated load current	1 Arms / 1 Adc	
Resistive load (AC-51 ⁰¹⁾)		
Min. load current	10 mA	
Max. surge current (t=10 ms)	4 A	
Leakage current (Ta = 25 °C)	\leq 2 mArms	\leq 2 mArms (240 VAC \sim 50 / 60 Hz)
Output ON voltage drop [Vpk] (Max. load current)	\leq 2.2 V	
Static off state dv/dt	500 V/ μ s	-
Operating time	\leq 2 ms	
Releasing time	\leq 1 ms	

01) AC-51 is utilization category at IEC60947-4-3.

[General specifications]

Dielectric strength (Vrms)	Input - output, input / output-case: 2500 VAC \sim 50/60 Hz for 1 min
Insulation resistance	\geq 100 M Ω (500 VDC \equiv megger)
Indicator	Input indicator (red)
Ambient temperature ⁰¹⁾	-20 ~ 80 °C (SRS1-A: -20 ~ 70 °C), storage: -30 ~ 100 °C (no freezing or no condensation)
Ambient humidity	45 ~ 85 %RH, storage: 45 ~ 85 %RH (no freezing or condensation)
Protection	According to protection of the using socket
Approval	CE  EAC

01) Refer to the 'SSR Derating Curve' because the capacity of the rated load current is differ depending on the ambient temperature.

Model	SRS1-A	SRS1-B	SRS1-C
Weight (packaged) ⁰¹⁾	\leq 3 A: \approx 17 g (\approx 270 g), 5 A: \approx 28 g (\approx 380 g)	\approx 30 g (\approx 400 g)	\approx 30 g (\approx 400 g)

01) The weight is per 10 units with packing and the weight of parenthesis is per 1

2 / 3-Phase

SSR with Detachable / Integrated Heatsink

SR2 / SR3 / SRH2 / SRH3 Series



Features

- Two mounting hole types and sizes
- Alarm function (overheat prevention): alarm indicator (red), disconnect output, alarm output
- Improved dielectric strength: 4,000 VAC~ (some are 2,500 VAC~ model)
- Rated input voltage: 4 - 30 VDC \equiv , 24 VAC~, 90 - 240 VAC~
- Rated load voltage: 24 - 240 VAC~, 48 - 480 VAC~
- Rated load current: 15 A, 30 A, 40 A, 50 A, 75 A
- High heat dissipation efficiency with ceramic PCB and integrated heatsink
- Zero cross turn-on / Random turn-on models available
- Input indicator (green)

Specifications

[Input]

Rated input voltage range	4 - 30 VDC \equiv	240 VACrms~ (50/60 Hz)	90 - 240 VACrms~ (50/60 Hz)
Allowable input voltage range	4 - 32 VDC \equiv	19 - 26.4 VACrms~ (50/60 Hz)	85 - 264 VACrms~ (50/60 Hz)
Max. input current	25 mA	15 mA	25 mA
Operating voltage	≥ 4 VDC \equiv	≥ 19 VACrms~	≥ 85 VACrms~
Releasing voltage	≤ 1 VDC \equiv	≤ 4 VACrms~	≤ 10 VACrms~
Operating time	Zero cross turn-on	≤ 0.5 cycle of load power + 1 ms	≤ 1.5 cycle of load power + 1 ms
	Random turn-on	≤ 1 ms	-
Releasing time	≤ 0.5 cycle of load power + 1 ms	≤ 1.5 cycle of load power + 1 ms	≤ 1.5 cycle of load power + 1 ms

[Output]

Rated load voltage range	24 - 240 VACrms~ (50/60 Hz)				
Allowable load voltage range	24 - 264 VACrms~ (50/60 Hz)				
Rated load current	Resistive load (AC-51) ⁰¹⁾	15 Arms	30 Arms	50 Arms	75 Arms
	Min. load current	0.15 Arms	0.2 Arms	0.5 Arms	0.5 Arms
Max. 1 cycle surge current (60 Hz)	250 A	400 A	1000 A	1000 A	
Max. non-repetitive surge current (I ² t, t = 8.3 ms)	340 A ² s	1000 A ² s	4000 A ² s	4000 A ² s	
Peak voltage (non-repetitive)	600 V				
Leakage current (Ta = 25 °C)	≤ 10 mA Arms (240 VAC~/60 Hz)				
Output ON voltage drop [Vpk] (max. load current)	≤ 1.6 V				
Static off state dv/dt	500 V/ μ s				

heatsink type

heatsink type

Rated load voltage range	48 - 480 VACrms~ (50/60 Hz)					
Allowable load voltage range	48 - 528 VACrms~ (50/60 Hz)					
Rated load current	Resistive load (AC-51) ⁰¹⁾	15 Arms	30 Arms	40 Arms	50 Arms	75 Arms
Min. load current	0.5 Arms					
Max. 1 cycle surge current (60 Hz)	300 A	500 A	500 A	1000 A	1000 A	
Max. non-repetitive surge current (I ² t, t = 8.3 ms)	350 A ² s	1000 A ² s	1000 A ² s	4000 A ² s	4000 A ² s	
Peak voltage (non-repetitive)	1200 V (zero cross turn-on), 1000 A (random turn-on)					
Leakage current (Ta = 25 °C)	≤ 10 mA Arms (480 VAC~/60 Hz)					
Output ON voltage drop [Vpk] (max. load current)	≤ 1.6 V					
Static off state dv/dt	500 V/μs					

01) AC-51 is utilization category at IEC609s47-4-3.

[Alarm output (overheat prevention function)]

Rated input voltage range	4 - 30 VDC=	24 VACrms~ (50/60 Hz)	90 - 240 VACrms~ (50/60 Hz)
Load voltage	≤ 30 VDC=	≤ 30 VDC=	≤ 30 VDC=
Load current	≤ 100 mA	≤ 50 mA	≤ 50 mA
Turn-off time	≤ 20 ms	≤ 40 ms	≤ 40 ms

• Overheat prevention function is when SSR internal temperature is overheated, the load output is cut off to prevent internal device damage and also the alarm indicator and alarm output turn ON.

[General specifications]

Dielectric strength (Vrms) : 24-240 VAC~	Rated load current 15 / 30 A : 2500 VAC~ 50/60 Hz for 1 min (input-output, input/output-case) Rated load current 50 / 75 A : 4000 VAC~ 50/60 Hz for 1 min (input-output, input/output-case)
Dielectric strength (Vrms) : 48-480 VAC~	4000 VAC~ 50/60 Hz for 1 min (input-output, input/output-case)
Insulation resistance	≥ 100 MΩ (500 VDC= megger) (input-output, input/output-case)
Indicator	Input indicator (green), alarm indicator (red)
Vibration	0.75 mm double amplitude at frequency of 10 to 55 Hz (for 1 min) in each X, Y, Z direction for 1 hour
Vibration (malfunction)	0.5 mm double amplitude at frequency of 10 to 55 Hz (for 1 min) in each X, Y, Z direction for 10 min
Shock	300 m/s ² (≈ 30 G) in each X, Y, Z direction for 3 times
Shock (malfunction)	100 m/s ² (≈ 10 G) in each X, Y, Z direction for 3 times
Ambient temperature ⁰¹⁾	-30 to 80 °C (in case of the rated input voltage 90 - 240 VAC~: -30 to 70 °C), storage: -30 to 100 °C (no freezing or condensation)
Ambient humidity	45 to 85%RH, storage: 45 to 85%RH (no freezing or condensation)
Input terminal connection / alarm output terminal connection	≥ 1×0.5 mm ² (1×AWG 20), ≥ 1×1.5 mm ² (1×AWG 16) or ≤ 2×1.5 mm ² (2×AWG 16)
Output terminal connection ⁰²⁾	≥ 1×1.5 mm ² (1×AWG 16), ≥ 1×16 mm ² (1×AWG 6) or ≤ 2×6 mm ² (2×AWG 10)
Input terminal fixed torque	0.75 to 0.95 N m
Output terminal fixed torque	1.6 to 2.2 N m
Approval	CE  ENEC

01) Refer to the 'SSR Derating Curve' in the product manual because the capacity of the rated load current is differ depending on the ambient temperature.

02) Connect the wire met the capacity of the load current to the output terminal.

Weight (packaged)		
Detachable heatsink type	≈ 275 g (≈ 365 g)	
Integrated heatsink type	15 / 30 / 40 A	≈ 686 g (≈ 896 g)
	50 A	≈ 1268 g (≈ 1508 g)
	75 A	≈ 2064 g (≈ 2354 g)



F3. Power Controllers

Power controllers are used to control the amount of electric currents in devices such as heaters, furnaces, thermostats, or motors.

F3-1	Multi-Channel	SPRM Series	Multi-Channel Power Controllers
F3-2	Single-Phase	SPR Series	Single-Phase / 3-Phase Slim Power Controllers
		DPU Series	Single-Phase / 3-Phase Digital Power Controllers
		SPC Series	Single-Phase Power Controllers

Multi-Channel Power Controllers



SPRM Series



Features

- Single-phase control / three-phase control
- Supports a wide range of rated voltages from 220 to 440 VAC~
- Various rated current models of 25 / 40 / 55 / 70 / 90 / 110 / 160 A
- Improved visibility with 4-line LCD display
- Monitoring load current / voltage / output / resistance / heatsink temperature / power
- Detachable display module can be installed on a separate panel
- Supports various alarms, heater brake, partial heater brake, fuse break, heatsink over heat, overcurrent, FAN error, etc. and saving alarm history
- Improved fuse replacement convenience with open / close structure
- Supports RS485, EtherCAT communication

Specifications

Model	SPRM3-F□R	SPRM3-F□EC
Control phases	Single phase 3 Ch or 3-phase	
Rated load voltage	Free voltage 220 - 440 VAC~ 50 / 60 Hz	
Rated load current ⁰¹⁾	25 / 40 / 55 / 70 / 90 / 110 / 160 A	
Display method	5 digit 11 segment LCD (white) × 4, Output BAR	
Auto control input	DC 4 - 20 mA × 3 Ch, 0 - 5 / 1 - 5 / 0 - 10 VDC=, External adjuster (10 kΩ), RS485, EtherCAT	
Manual control input	Parameter setting	
Digital input (DI)	RUN / STOP selectable, AUTO / MANU selectable, RESET	
Alarm output	250 VAC~ 2 A, 30 VDC= 2 A, 1c resistance load	
Comm. output	RS485	RS485, EtherCAT
Cooling method	Rated load current 25 / 40 / 55 A: natural cooling Rated load current 70 / 90 / 110 / 160 A: forced air cooling (with cooling fan)	
Unit weight (packaged)	Rated load current 25 / 40 / 55 A: ≈ 4.75 kg (≈ 5.75 kg) Rated load current 70 A: ≈ 4.8 kg (≈ 5.8 kg) Rated load current 90 / 110 / 160 A: ≈ 9.42 kg (≈ 10.55 kg)	
Approval	CE, RoHS, REACH, IEC	
01) It is the rated load current of each channel in single-phase operation.		
Control method	Phase control	Cycle control
Control mode	Normal / Constant current feedback / Constant voltage feedback / Constant power feedback	Fixed cycle / Variable cycle
Applied load	Resistance load, inductive load	Resistance load
Output range	0 to 98 %	0 to 100 %
Output accuracy	Varies by control mode	
Normal	Within ± 10 % F.S. of rated load voltage	-
Constant current / voltage / power feedback	Within ± 3 % F.S. of rated load current / voltage / power	-
Power supply	24 VDC= ± 10 %	
Min. load current	1 A	
Power consumption	≤ 15 W	
Insulation resistance	≥ 200 MΩ (500 VDC= megger)	
Dielectric strength	Between load input and power terminal: 3,000 VAC~ 50 / 60 Hz for 1 min	
Output leakage current	≤ 10 mA _{rms}	
Noise immunity	± 500 V square wave noise (pulse width: 1 μs) by the noise simulator	
Memory retention	≈ 10 years (when using non-volatile semiconductor memory type)	
Vibration	0.5 mm double amplitude at frequency of 5 to 55 Hz (for 1 min) in each X, Y, Z direction for 2 hours	
Vibration (malfunction)	0.5 mm double amplitude at frequency of 5 to 55 Hz (for 1 min) in each X, Y, Z direction for 10 min	
Ambient temperature	-10 to 40 °C, storage: -20 to 80 °C (no freezing or condensation)	
Ambient humidity	35 to 85 %RH, storage: 35 to 85 %RH (no freezing or condensation)	
Comm. protocol	Modbus RTU (16 bit CRC), Modbus ASCII, EtherCAT	

Single-Phase / 3-Phase Slim Power Controllers

SPR Series



Features

- Slim and elegant design
- LED display allows real-time monitoring of control input, load voltage, load current, load power, load resistance, and heat-sink temperature
- Stable control with feedback control (constant current, constant voltage, constant power)
- Communication output models available: RS485 (Modbus RTU)
- Parameter configuration via PCs (RS485): Free device management software (DAQMaster)
- Various alarm functions (alarm output): over current, over voltage, heater disconnection, fuse break, heat-sink over heat, diode (SCR) error
- Easy installation with mounting brackets
- Easy fuse replacement and maintenance
- High performance SCR (IXYS) diode

Specifications

[Single-Phase]

Model	SPR1-1 □	SPR1-2 □	SPR1-□	SPR1-4 □
Control phase	Single-phase			
Rated load voltage	110 VAC~ 50 / 60 Hz	220 VAC~ 50 / 60 Hz	380 VAC~ 50 / 60 Hz	440 VAC~ 50 / 60 Hz
Rated load current	25 / 35 / 50 / 70 / 100 / 150 A			
Display method	3-digit 7segment LED			
Indicators	Operation / manual control indicator (green) Alarm / output / unit (V, A) indicator (red)			
Auto control input	Current: DC 4 - 20 mA, voltage: 1 - 5 VDC=, contact (non-voltage): ON / OFF, contact (voltage): 5 - 12 VDC=, communication: RS485			
Manual control input	External adjuster (10 kΩ), output control adjuster (OUT ADJ)			
Digital input (DI)	RUN / STOP selectable, AUTO / MAN selectable, RESET			
Alarm output	250 VAC~ 3 A, 30 VDC= 3 A, 1c resistance load			
RS485 comm. output	Modbus RTU method			
Cooling method	Rated load current 25 / 35 / 50 A: natural cooling Rated load current 70 / 100 / 150 A: forced air cooling (with cooling fan)			
Unit weight (packaged)	Rated load current 25 / 35 / 50 A: ≈ 1.3 kg (≈ 1.6 kg) Rated load current 70 A: ≈ 1.35 kg (≈ 1.65 kg) Rated load current 100 / 150 A: ≈ 2.8 kg (≈ 3.2 kg)			
Approval	CE			
Control method	Phase control	Cycle control	ON/OFF control	
Control mode	Normal, constant current feedback/ constant voltage feedback/ constant power feedback	Fixed cycle / variable cycle	-	
Applied load	Resistance load, inductive load	Resistance load	Resistance load, inductive load	
Output range	0 to 98 %	0 to 100 %	0 / 100 %	
Output accuracy	Varies by control mode			
Normal	Within ± 10 % F.S. of rated load voltage	-	-	
Constant current / voltage / power feedback	Within ± 3 % F.S. of rated load current / voltage / power	-	-	

Next Page ►

Power supply	100 - 240 VAC ~ ± 10 % 50 / 60Hz
Min. load current	1 A
Power consumption	Rated load current 25 / 35 / 50 A: ≤ 7 VA Rated load current 70 / 100 / 150 A: ≤ 12 VA
Insulation resistance	≥ 200 MΩ (500 VDC≡ megger)
Dielectric strength	Between input and power terminal: 2,000 VAC ~ 50 / 60 Hz for 1 min
Output leakage currents	≤ 10 mArms
Noise immunity	±2 kV square wave noise (pulse width: 1 μs) by the noise simulator
Memory retention	≈ 10 years (when using non-volatile semiconductor memory type)
Vibration	0.75 mm double amplitude at frequency of 5 to 55 Hz (for 1 min) in each X, Y, Z direction for 2 hours
Vibration (malfunction)	0.5 mm double amplitude at frequency of 5 to 55 Hz (for 1 min) in each X, Y, Z direction for 10 min
Ambient temp.	-10 to 55 °C, storage: -20 to 80 °C (no freezing or condensation)
Ambient humi.	35 to 85 %RH, storage: 35 to 85 %RH (no freezing or condensation)
Comm. protocol	Modbus RTU

[3-Phase]

Model	SPR3-1 □	SPR3-2 □	SPR3-3 □	SPR3-4 □
Control phase	3-Phase			
Rated load voltage	110 VAC ~ 50 / 60 Hz	220 VAC ~ 50 / 60 Hz	380 VAC ~ 50 / 60 Hz	440 VAC ~ 50 / 60 Hz
Rated load current	25 / 35 / 50 / 70 / 100 / 150 A			
Display method	3-digit 7segment LED			
Indicators	Operation / manual control indicator (green) Alarm / output / unit (V, A) indicator (red)			
Auto control input	Current: DC 4 - 20 mA, voltage: 1 - 5 VDC≡, contact (non-voltage): ON / OFF, contact (voltage): 5 - 12 VDC≡, communication: RS485			
Manual control input	External adjuster (10 kΩ), output control adjuster (OUT ADJ)			
Digital input (DI)	RUN / STOP selectable, AUTO / MAN selectable, RESET			
Alarm output	250 VAC ~ 3 A, 30 VDC≡ 3 A, 1c resistance load			
RS485 comm. output	Modbus RTU method			
Cooling method	Rated load current 25 / 35 / 50 A: natural cooling Rated load current 70 / 100 / 150 A: forced air cooling (with cooling fan)			
Unit weight (packaged)	Rated load current 25 / 35 / 50 A: ≈ 4.1 kg (≈ 4.9 kg) Rated load current 70 A: ≈ 4.2 kg (≈ 5 kg) Rated load current 100 / 150 A: ≈ 8.7 kg (≈ 9.7 kg)			
Approval	CE			
Control method	Phase control	Cycle control	ON/OFF control	
Control mode	Normal / constant current feedback / constant voltage feedback / constant power feedback	Fixed cycle	-	
Applied load	Resistance load, inductive load	Resistance load	Resistance load, inductive load	
Output range	0 to 98 %	0 to 100 %	0 / 100 %	
Phase control output accuracy	<ul style="list-style-type: none"> • Normal control: within ± 10 % F.S. of rated load voltage • Constant current feedback control: within ± 3 % F.S. of rated load current • Constant voltage feedback control: within ± 3 % F.S. of rated load voltage • Constant power feedback control: within ± 3 % F.S. of rated load power 			
Power supply	100 - 240 VAC ~ ± 10 % 50 / 60 Hz			
Min. load current	1 A			
Power consumption	Rated load current 25 / 35 / 50 A: ≤ 14 VA Rated load current 70 A: ≤ 22 VA Rated load current 100 / 150 A: ≤ 32 VA			
Insulation resistance	≥ 200 MΩ (500 VDC≡ megger)			
Dielectric strength	Between input and power terminal: 2,000 VAC ~ 50 / 60 Hz for 1 min			
Output leakage currents	≤ 10 mArms			
Noise immunity	±2 kV square wave noise (pulse width: 1 μs) by the noise simulator			
Memory retention	≈ 10 years (when using non-volatile semiconductor memory type)			
Vibration	0.75 mm double amplitude at frequency of 5 to 55 Hz (for 1 min) in each X, Y, Z direction for 2 hours			
Vibration (malfunction)	0.5 mm double amplitude at frequency of 5 to 55 Hz (for 1 min) in each X, Y, Z direction for 10 min			
Ambient temp.	-10 to 55 °C, storage: -20 to 80 °C (no freezing or condensation)			
Ambient humi.	35 to 85 %RH, storage: 35 to 85 %RH (no freezing or condensation)			
Comm. protocol	Modbus RTU			

Single-Phase / 3-Phase Digital Power Controllers

DPU Series



Features

- High speed and high accuracy by digital control using high speed CPU
- Various controls
 - Phase control, feedback control (constant voltage / constant current / constant power)
 - Zero crossing cycle control (fixed / variable cycles)
 - Zero crossing ON / OFF control
- Improved maintainability with built-in fast-acting fuse and easy fuse replacement
- Communication output model: RS485 (Modbus RTU)
- Various control inputs and DI inputs
 - Control input: analog (current, voltage), ON / OFF (voltage pulse, no voltage), communication (RS485), potentiometer
 - DI input: AUTO / MAN switching, RUN / STOP switching, Reset, output holding, SP designation (6 setting points can be customized)
- Various alarm output
 - Overcurrent, overvoltage, fuse break, heat sink overheat, device fault, heater break alarm (partial heater break detection)
- Improved convenience by separating operation part
- Applicable load
 - Supercantal, platinum, molybdenum, carbon, halogen lamps, chrome, nickel, etc.

Specifications

Series	DPU1	DPU3
Control phase	Single-phase	3-phase
Rated frequency	50 / 60 Hz (auto recognition), allowable frequency range: ± 2 Hz	
Min. load current	1 A	
Output range	Phase control: 0 to 98 %, Z.C. control: 0 to 100 %	
Control method	<ul style="list-style-type: none"> • Phase control: normal / constant current feedback / constant voltage feedback / constant power feedback • Cycle control (Z.C.): fixed cycle / variable cycle⁰¹⁾ • ON / OFF control (Z.C.) 	
Load	<ul style="list-style-type: none"> • Phase control: resistance load, inductive load • ON / OFF, cycle control : resistance load 	
Phase control output accuracy	<ul style="list-style-type: none"> • Normal: within ± 10 % F.S. of rated load voltage • Constant voltage feedback: within ± 3 % F.S. of rated load voltage (within variable ± 10 % F.S. of rated voltage) • Constant current feedback: within ± 3 % F.S. of rated load current (within variable 1 to 10 times of rated resistance) • Constant power feedback: within ± 3 % F.S. of rated load power (within variable ± 10 % F.S. of rated power, within variable 1 to 10 times of rated resistance) 	
Control input	<ul style="list-style-type: none"> • Auto : 4 - 20 mA / 0 - 20 mA / 0 - 5 VDC\equiv / 1 - 5 VDC\equiv / 0 - 10 VDC\equiv / voltage pulse (0 / 12 VDC\equiv (24 VDC\equiv)) / non-voltage input (ON / OFF) / communication input (RS485) • Manual : internal 10 kΩ adjuster, external 3 to 10 kΩ adjuster (≥ 2 W) 	
Digital input (DI)	AUTO / MAN selectable, RUN / STOP selectable, RESET, output holding, SP set (SP 1 to 6)	
Display type	Control input, load voltage, load current, load power, load resistance, power supply frequency	
Min. display output	Over 2.5 % of rated voltage / current	
Approval	CE ENEC	
<small>01) Only for single-phase</small>		
Power supply	110 / 220 / 380 / 440 VAC \sim model (fan and control power 220 VACs \sim 50 / 60 Hz separately)	
Allowable voltage range	Single-phase: 90 to 110 % of power supply 3-phase: 85 to 115 % of power supply	
Power consumption	Single-phase: ≤ 7 W (except fan power) 3-phase: ≤ 10 W (except fan power)	
Display method	<ul style="list-style-type: none"> • Display value and setting value display: 7 segment 4-digit • State display: Single-phase LED \times 4, 3-phase LED \times 6 • Display value percentage display: 11 LED bar 	
Dielectric strength	Between input terminal and power terminal: 2000 VAC \sim 50 / 60 Hz for 1 min	
Vibration	0.75 mm double amplitude at frequency of 5 to 55 Hz (for 1 min) in each X, Y, Z direction for 2 hours	
Insulation resistance	≥ 200 M Ω (500 VDC \equiv megger)	
Noise immunity	± 2 kV square wave noise (pulse width: 1 μ s) by the noise simulator	
Ambient temp.	-10 to 50 $^{\circ}$ C, storage: -20 to 80 $^{\circ}$ C (no freezing or condensation)	
Ambient humidity	5 to 90 %RH, storage: 5 to 90 %RH (no freezing or condensation)	
Comm. protocol	Modbus RTU	
Unit weight (packaged)	Single-phase	3-phase
A	≈ 3.0 kg (≈ 3.2 kg)	≈ 6.5 kg (≈ 7.6 kg)
B	≈ 3.0 kg (≈ 5.6 kg)	≈ 11.5 kg (≈ 13.0 kg)
C	≈ 11.0 kg (≈ 12.1 kg)	≈ 20.0 kg (≈ 21.1 kg)
D	≈ 11.0 kg (≈ 19.3 kg)	≈ 30.8 kg (≈ 35.7 kg)

Single-Phase Power Controllers

SPC Series

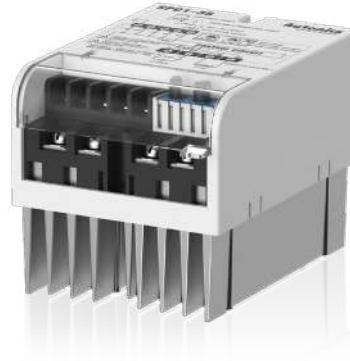

Features

- Various and simple input specification
 - DC 4 - 20 mA, 1 - 5 VDC \Rightarrow , External 24 VDC \Rightarrow
 - External adjuster (1 k Ω)
 - External contact (ON / OFF)
- Various function
 - Out ADJ (output limit) function
 - Soft Start function
(except for ON / OFF control type)
 - Out display function
 - 50 / 60 Hz automatic converting function
- Various control by mode switches
 - Phase control
 - Cycle control (zero cross turn-on)
 - ON / OFF control (zero cross turn-on)

Specifications

Model	SPC1-35	SPC1-50	
Control phase	Single-phase		
Rated load current	35 A	50 A	
Indicator	Output indicator (red)		
Control input	1 - 5 VDC \Rightarrow , DC 4 - 20 mA (250 Ω), ON / OFF (external contact or 24 VDC \Rightarrow), external adjuster (1 k Ω), output limit input (front output limit adjuster)		
Cooling method	Natural air cooling		
Control circuit	MICOM control method		
Unit weight	\approx 1 kg		
Approval	ERC		
Control mode	Normal	Fixed cycle	-
Applied load	Resistance load		
Output range	0 to 98 %	0 to 100 %	0 / 100 %
Power supply	220 VAC \sim \pm 10 % 50 / 60Hz \pm 1 Hz		
Min. load current	5 % of rated load current		
Insulation resistance	100 M Ω (500 VDC \Rightarrow megger)		
Dielectric strength	2000 VAC \sim 50 / 60 Hz for 1 min		
Noise immunity	\pm 2 kV square wave noise (pulse width: 1 μ s) by the noise simulator		
Vibration	0.75 mm double amplitude at frequency of 10 to 55 Hz (for 1 min) in each X, Y, Z direction for 1 hour		
Vibration (malfunction)	0.5 mm double amplitude at frequency of 10 to 55 Hz (for 1 min) in each X, Y, Z direction for 10 min		
Shock	300 m/s ² (\approx 30 G) in each X, Y, Z direction for 3 times		
Shock (malfunction)	100 m/s ² (\approx 10 G) in each X, Y, Z direction for 3 times		
Ambient temperature	0 to 50 $^{\circ}$ C, storage: -25 to 65 $^{\circ}$ C (no freezing or condensation)		
Ambient humidity	35 to 85 %RH, storage: 35 to 85 %RH (no freezing or condensation)		
Wiring spec.	Rated load current 35 A: AWG 16 to 8 Rated load current 50 A: AWG 8 to 6		

G. Motion Devices

Motion devices are used to convert electrical energy into mechanical energy acting as actuators in automation processes.

- G1. Closed Loop Stepper System
- G2. 2-Phase Stepper Motor Drivers
- G3. 5-Phase Stepper Motor & Drivers
- G4. Motion Controllers

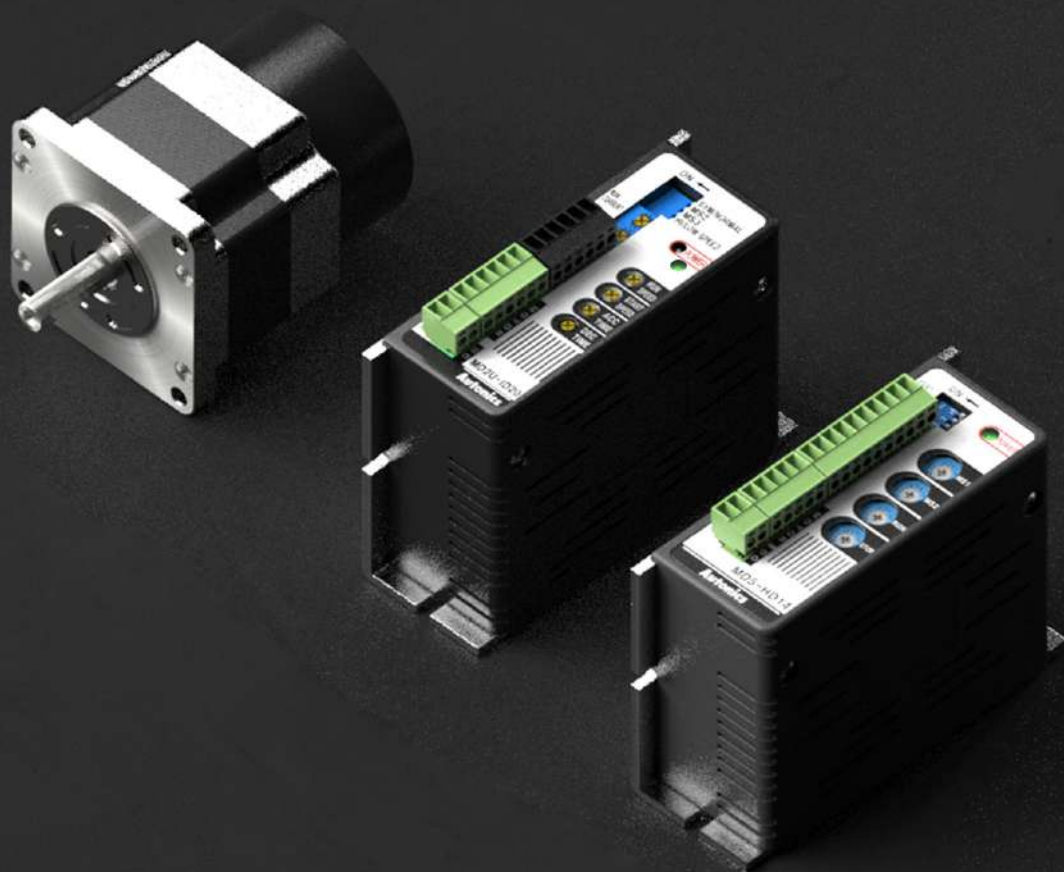





G1. 2-Phase Closed-Loop Stepper Motor System

Closed-loop stepper motor systems consist of motors with integrated encoders for feedback and higher precision control.

G1-1	Closed-Loop Stepper Motor System	AiS Series	2-Phase Closed-Loop Stepper Motor System
		AiSA Series	AC Power Input 2-Phase Closed-Loop Stepper Motor System
		AiC Series	2-Phase Closed-Loop Stepper Motor Drivers with Integrated Controller
		AiC-CL Series	CC-Link Comm. Type 2-Phase Closed-Loop Stepper Motor System
		AiC-EC Series	EtherCAT Comm. Type 2-Phase Closed-Loop Stepper Motor System
		AiCA Series	AC Power Input 2-Phase Closed-Loop Stepper Motor System
		AiCA-EC Series	AC Power Input EtherCAT Comm. Type 2-Phase Closed-Loop Stepper Motor System
Closed-Loop Stepper Motor System (Motor)	Ai-M / Ai-M-B Series	Standard / Built-In Brake Type 2-Phase Closed-Loop Stepper Motor	
	Ai-M Series	Standard Type 2-Phase Closed-Loop Stepper Motor	
	Ai-M-G / Ai-M-R Series	Built-In Gear / Rotary Actuator Type 2-Phase Closed-Loop Stepper Motor	
	AiA-M / AiA-M-B Series	Standard / Built-In Brake Type AC Power Input 2-Phase Closed-Loop Stepper Motor	
	AiA-M-G / AiA-M-R Series	Built-In Gear / Rotary Actuator Type AC Power Input 2-Phase Closed-Loop Stepper Motor	

2-Phase Closed-Loop Stepper Motor System

AiS Series



Features

- Closed-loop system with real-time position control
- High speed & high torque drive without missing steps
- Easy operation setting with external adjuster (Gain, Speed filter, In-position, Resolution)
- Built-in brake type motors available (AiS-D-B Series)

[Supported Motor*]

- Standard type: 20, 28, 35, 42, 56, 60 mm
- Built-in brake type: 42, 56, 60 mm
- Built-in gear type: 42, 60 mm
- Built-in rotary actuator type : 60 mm

Specifications

[Supported Driver]

Model	AiS-D-20□A	AiS-D-28□B	AiS-D-35□B
Power supply	24 VDC \pm 10%		
Max. RUN power ⁰¹⁾	≤ 50 W	≤ 60 W	
Stop power ⁰²⁾	≤ 10 W		
Max. RUN current ⁰³⁾	0.6 A / Phase	1.0 A / Phase	1.2 A / Phase
Stop current	25% or 50% (factory default: 50%) of max. RUN current		
Resolution	500 (factory default), 1000, 1600, 2000, 3600, 4000, 5000, 6400, 7200, 10000 PPR	500 (factory default), 1000, 1600, 2000, 3600, 5000, 6400, 7200, 10000, 16000 PPR	

Model	AiS-D-42□A-□	AiS-D-56□A-□	AiS-D-60□A-□
Power supply	24 VDC \pm 10%		
Max. RUN power ⁰¹⁾	≤ 60 W	≤ 120 W	≤ 240 W
Stop power ⁰²⁾	S: ≤ 7 W (≤ 16 W) M: ≤ 7.5 W (≤ 16 W) L: ≤ 8 W (≤ 17 W)	S: ≤ 9.5 W (≤ 23 W) M: ≤ 10 W (≤ 23 W) L: ≤ 11 W (≤ 25 W)	S: ≤ 12 W (≤ 25 W) M: ≤ 13 W (≤ 26 W) L: ≤ 14 W (≤ 26 W)
Max. RUN current ⁰³⁾	1.7 A / Phase	3.5 A / Phase	
Stop current	25% or 50% (factory default: 50%) of max. RUN current		
Resolution	500 (factory default), 1000, 1600, 2000, 3200, 3600, 5000, 6400, 7200, 10000 PPR		

01) When changing the load rapidly, instantaneous peak current may increase. The capacity of power supply should be over 1.5 to 2 times of max. RUN power.

02) Based on ambient temp. 25°C, ambient humi. 55%RH, stop current 50%. The value in the bracket indicates built-in brake type.

03) RUN current varies depending on the input RUN frequency and max. RUN current at the moment varies also.

Run method	2-phase bipolar closed-loop control method
Speed filter	Disable, 2, 4, 6, 8, 10, 20, 40, 60 (factory default), 80, 100, 120, 140, 160, 180, 200 ms
Control Gain	(P Gain, I Gain)=(1, 1), (2, 1), (3, 1), (4, 1), (5, 1), (1, 2), (2, 2), (3, 2), (4, 2), (5, 2), (1, 3), (2, 3), (3, 3), (4, 3), (5, 3)
Max. rotation speed	3000 rpm
In-Position	Fast Response: 0 (factory default) to 7, Accurate Response: 0 to 7
Rotation direction	CW (factory default), CCW
Input	CW/CCW (RUN pulse), Servo ON/OFF, Alarm Reset (Photocoupler input)
Output	In-Position, Alarm Out (Photocoupler output), Encoder Signal (A, \bar{A} , B, \bar{B} , Z, \bar{Z} , Line driver output), Brake (at supplying: 0.2 sec 24 VDC \pm , normal status: 11.5 VDC \pm 10%)
Pulse input method	1 pulse, 2 pulse (factory default)
Pulse input voltage	CW, CCW-[H]: 4 - 8 VDC \pm , [L]: 0 - 0.5 VDC \pm , Servo ON/OFF, Alarm Reset-[H]: 24 VDC \pm , [L]: 0 - 0.5 VDC \pm
Max. input pulse frequency	□ 20 / 28 / 35 mm: CW, CCW: 800 kHz □ 42 / 56 / 60 mm: CW, CCW: 500 kHz
Pulse width	CW, CCW: Input Pulse Frequency Duty 50% (□ 20 mm: ≥ 2 μ s, □ 28 / 35 mm: ≥ 1.25 μ s) Servo ON/OFF: ≥ 1 ms Alarm Reset: ≥ 20 ms
Rise fall time	CW, CCW: < 0.5 μ s

Input resistance	220 Ω (CW, CCW), 10 k Ω (Servo ON/OFF, Alarm Reset)
Insulation resistance	\geq 100 M Ω (500 VDC= megger)
Dielectric strength	1,000 VAC~ 60 Hz for 1 minute
Vibration	1.5 mm double amplitude at frequency 10 to 55 Hz (for 1 minute) in each X, Y, Z direction for 2 hours
Shock	300 m/s ² (\approx 30 G) in each X, Y, Z direction for 3 times
Ambient temp.	<input type="checkbox"/> 20 / 28 / 35 mm: 0 to 50°C, storage: -20 to 70°C (no freezing or condensation) <input type="checkbox"/> 42 / 56 / 60 mm: 0 to 50°C, storage: -10 to 60°C (no freezing or condensation) Built-in brake type: 0 to 50°C, storage: -20 to 70°C (no freezing or condensation)
Ambient humi.	35 to 85%RH, storage: 10 to 90%RH (no freezing or condensation)
Protection rating	IP20 (IEC standard)
Approval	CE ENEC
Unit weight (packaged)	\approx 290 g (\approx 400 g)

AC Power Input

2-Phase Closed-Loop Stepper Motor System

AiSA Series



Features

- Closed-loop system with real-time position control
- High speed & high torque drive without missing steps
- Supports 200 - 240 VAC~ AC power
- Easy operation setting with external adjuster (Gain, Speed filter, In-position, Resolution)
- 7 segment display for alarm / status reading
- Supports torque mode
- Supports Auto Current Down mode
- Built-in brake type motors available (AiSA-D-B Series)

[Supported Motor*]

- Standard type: 60, 86 mm
- Built-in brake type: 60, 86 mm
- Built-in gear type: 60, 86 mm
- Built-in rotary actuator type : 60 mm

Specifications

[Supported Driver]

Model	AiSA-D-60MA-□	AiSA-D-60LA-□	AiSA-D-86MA-□	AiSA-D-86LA-□	
Main	Power supply	200 - 240 VAC~ 50 / 60 Hz			
	Max. RUN power ⁰¹⁾	≤ 800 VA			
	Stop power ⁰²⁾	≤ 60 VA		≤ 65 VA	≤ 70 VA
AUX ⁰³⁾	Power supply	24 VDC≒			
	Input current	0.3 A		0.5 A	
	Max. RUN current ⁰⁴⁾	2.0 A / Phase			
Stop current	20% to 100% of max. RUN current				
Resolution	500 (factory default), 1000, 1600, 2000, 3200, 3600, 5000, 6400, 7200, 10000 PPR				

01) When changing the load rapidly, instantaneous peak current may increase. The capacity of power supply should be over 1.5 to 2 times of max. RUN power.

02) Based on ambient temp. 25°C, ambient humi. 55%RH, stop current 50%

03) Auxiliary power is only available in built-in brake type and not available in standard type.

04) RUN current varies depending on the input RUN frequency and max. RUN current at the moment varies also.

Run method	2-phase bipolar closed-loop control method
Speed filter	Disable (factory default), 2, 4, 6, 8, 10, 20, 40, 60, 80, 100, 120, 140, 160, 180, 200 ms
Control Gain	Standard Gain: 0 to F, Inertia Gain: 0 to F
Max. rotation speed	3000 rpm
In-Position	Fast Response: 0 (factory default) to 7, Accurate Response: 0 to 7
Rotation direction	CW (factory default), CCW
Operation mode	Standard mode, Torque mode
Input	CW/CCW (RUN pulse), Servo ON/OFF, Alarm Reset (Photocoupler input)
Output	In-Position, Alarm Out (Photocoupler output), Encoder Signal (A, \bar{A} , B, \bar{B} , Z, \bar{Z} , Line driver output)
Pulse input method	1 pulse, 2 pulse (factory default)
Pulse input voltage	CW, CCW-[H]: 4 - 8 VDC≒, [L]: 0 - 0.5 VDC≒, Servo ON/OFF, Alarm Reset-[H]: 24 VDC≒, [L]: 0 - 0.5 VDC≒
Max. input pulse frequency	CW, CCW: 500 kHz
Pulse width	CW, CCW: Input pulse frequency duty 50% Servo ON/OFF: ≥ 1 ms Alarm Reset: ≥ 10 ms
Rise fall time	CW, CCW: < 0.5 μs
Input resistance	4.7 kΩ (Anode Pull-Up)
Insulation resistance	≥ 200 MΩ (500 VDC≒ megger)
Dielectric strength	1,500 VAC~ 60 Hz for 1 minute
Vibration	1.5 mm double amplitude at frequency 10 to 55 Hz (for 1 minute) in each X, Y, Z direction for 2 hours
Shock	300 m/s ² (≈ 30 G) in each X, Y, Z direction for 3 times
Ambient temp.	0 to 50°C, storage: -10 to 60°C (no freezing or condensation)
Ambient humi.	35 to 85%RH, storage: 10 to 90%RH (no freezing or condensation)
Protection rating	IP20 (IEC standard)
Approval	CE ENEC
Unit weight (packaged)	≈ 780 g (≈ 1,020 g)

2-Phase Closed-Loop Stepper Motor System with Integrated Controller

AiC Series



Features

- Closed-loop system with real-time position control
- High speed & high torque drive without missing steps
- Motor driver+Controller integrated type
- Control up to 31 axes with RS-485 communication
- Windows-based software (atMotion) for easy parameter setting and monitoring
- 4 operation mode: Jog mode, Continuous mode, Index mode, Program Mode
- Built-in brake type motors available (AiC-D-B Series)

[Supported Motor*]

- Standard type: 20, 28, 35, 42, 56, 60 mm
- Built-in brake type: 42, 56, 60 mm
- Built-in gear type: 42, 60 mm
- Built-in rotary actuator type : 60 mm

Specifications

[Supported Driver]

Model	AiC-D-20□A	AiC-D-28□B	AiC-D-35□B
Power supply	24 VDC \pm 10%		
Max. RUN power ⁰¹⁾	\leq 60 W		
Stop power ⁰²⁾	\leq 10 W		
Max. RUN current ⁰³⁾	0.6 A / Phase	1.0 A / Phase	1.2 A / Phase
Stop current	20 to 100% of max. RUN current (factory default: 50%)		
Resolution	500 (factory default), 1000, 1600, 2000, 3600, 4000, 5000, 6400, 7200, 10000 PPR		

Model	AiC-D-42□A-□	AiC-D-56□A-□	AiC-D-60□A-□
Power supply	24 VDC \pm 10%		
Max. RUN power ⁰¹⁾	\leq 60 W	\leq 120 W	\leq 240 W
Stop power ⁰²⁾	\leq 10 W	\leq 12 W	\leq 15 W
Max. RUN current ⁰³⁾	1.7 A / Phase	3.5 A / Phase	
Stop current	20 to 100% of max. RUN current (factory default: 50%)		
Resolution	500 (factory default), 1000, 1600, 2000, 3200, 3600, 5000, 6400, 7200, 10000 PPR		

01) When changing the load rapidly, instantaneous peak current may increase. The capacity of power supply should be over 1.5 to 2 times of max. RUN power.

02) Based on ambient temp. 25°C, ambient humi. 55%RH, stop current 50%

03) RUN current varies depending on the input RUN frequency and max. RUN current at the moment varies also.

Run method	2-phase bipolar closed-loop control method
Speed filter	Disable, 2, 4, 6, 8, 10, 20, 40, 60 (factory default), 80, 100, 120, 140, 160, 180, 200 ms
Control Gain	0 (factory default) ~ 14, Fine Gain
Max. rotation speed	3000 rpm
Positioning range	-2,147,483,648 to +2,147,483,647
In-Position	Fast Response: 0 (factory default) to 7, Accurate Response: 0 to 7
Rotation direction	CW (factory default), CCW
Operation mode	Jog mode, Continuous mode, Index mode, Program mode
Home search mode	General mode, Limit mode, Zero point mode, Torque mode
Index step	64 step
Program step	256 step
Program function	Power On Program Start, Power On Home Search
Control command	ABS, INC, HOM, ICJ, IRD, OPC, OPT, JMP, REP, RPE, END, POS, TIM, CMP
I/O voltage level	[H]: 5 - 30 VDC \pm , [L]: 0 - 2 VDC \pm
Input ⁰¹⁾	Exclusive input: 20, General input: 9
Output	Standard type - Exclusive output: 4, General output: 10 Built-in brake type - Exclusive output: 6, Generaloutput: 9
External power supply	VEX (recommended: 24 VDC \pm): 2, GEX (GND): 2
Insulation resistance	\geq 100 M Ω (500 VDC \pm megger)
Dielectric strength	1,000 VAC \sim 60 Hz for 1 minute
Vibration	1.5 mm double amplitude at frequency 10 to 55 Hz (for 1 minute) in each X, Y, Z direction for 2 hours
Shock	300 m/s ² (\approx 30 G) in each X, Y, Z direction for 3 times
Ambient temp.	0 to 50°C, storage: -10 to 60°C (no freezing or condensation)
Ambient humi.	35 to 85%RH, storage: 10 to 90%RH (no freezing or condensation)
Protection rating	IP20 (IEC standard)
Approval	CE ENEC
Unit weight (packaged)	\approx 300 g (\approx 460 g)
Comm. protocol	Modbus RTU

01) Brake ON/OFF function can be changed from general input IN8 in case of built-in brake type.

CC-Link Comm. Type

2-Phase Closed-Loop Stepper Motor System

AiC-CL Series



Features

- Closed-loop system with real-time position control
- High speed & high torque drive without missing steps
- Multi-axis simultaneous control with CC-Link communication
- Windows-based software (atMotion) for easy parameter setting and monitoring
- 7 segment display for alarm / status reading
- Built-in brake type motors available (AiC-D-B-CL Series)

[Supported Motor*]

- Standard type: 20, 28, 35, 42, 56, 60 mm
- Built-in brake type: 42, 56, 60 mm
- Built-in gear type: 42, 60 mm
- Built-in rotary actuator type : 60 mm

Specifications

[Supported Driver]

Model	AiC-D-20□A-CL	AiC-D-28□B-CL	AiC-D-35□B-CL
Power supply	24 VDC \pm 10%		
Max. RUN power ⁰¹⁾	\leq 60 W		
Stop power ⁰²⁾	\leq 10 W		
Max. RUN current ⁰³⁾	0.6 A / Phase	1.0 A / Phase	1.2 A / Phase
Stop current	20 to 100% of max. RUN current (factory default: 50%)		
Resolution	500 (factory default), 1000, 1600, 2000, 3600, 4000, 5000, 6400, 7200, 10000 PPR	500 (factory default), 1000, 1600, 2000, 3600, 5000, 6400, 7200, 10000, 16000 PPR	

Model	AiC-D-42□A-□-CL	AiC-D-56□A-□-CL	AiC-D-60□A-□-CL
Power supply	24 VDC \pm 10%		
Max. RUN power ⁰¹⁾	\leq 60 W	\leq 120 W	\leq 240 W
Stop power ⁰²⁾	\leq 10 W	\leq 12 W	\leq 15 W
Max. RUN current ⁰³⁾	1.7 A / Phase	3.5 A / Phase	
Stop current	20 to 100% of max. RUN current (factory default: 50%)		
Resolution	500 (factory default), 1000, 1600, 2000, 3200, 3600, 5000, 6400, 7200, 10000 PPR		

01) When changing the load rapidly, instantaneous peak current may increase. The capacity of power supply should be over 1.5 to 2 times of max. RUN power.

02) Based on ambient temp. 25°C, ambient humi. 55%RH, stop current 50%

03) RUN current varies depending on the input RUN frequency and max. RUN current at the moment varies also.

Run method	2-phase bipolar closed-loop control method
Speed filter	Disable, 2, 4, 6, 8, 10, 20, 40, 60 (factory default), 80, 100, 120, 140, 160, 180, 200 ms
Control Gain	0 (factory default) to 14, Fine Gain
Max. rotation speed	3000 rpm
Positioning range	-2,147,483,648 to +2,147,483,647
In-Position	Fast response: 0 (factory default) to 7, Accurate response: 0 to 7
Rotation direction	CW (factory default), CCW
Operation mode	Jog mode, Continuous mode, Index mode, Program mode
Home search mode	General mode, Limit mode, Zero point mode, Torque mode
Index steps	64 step
Program steps	256 step
Program function	Power On Program Start, Power On Home Search
Control command	ABS, INC, HOM, ICJ, IRD, OPC, OPT, JMP, REP, RPE, END, POS, TIM
I/O voltage level	[H]: 5 - 30 VDC \pm , [L]: 0 - 2 VDC \pm
Input	Exclusive input: 3, General input: 8
Output	General output: 7
External power supply	VEX (recommended: 24 VDC \pm), GEX (GND)
Insulation resistance	\geq 100 M Ω (500 VDC \pm megger)
Dielectric strength	1,000 VAC \sim 60 Hz for 1 minute
Vibration	1.5 mm double amplitude at frequency of 10 to 55 Hz (for 1 minute) in each X, Y, Z direction for 2 hours
Shock	300 m/s ² (\approx 30 G) in each X, Y, Z direction for 3 times
Ambient temp.	0 to 50°C, storage: -10 to 60°C (no freezing or condensation)
Ambient humi.	35 to 85%RH, storage: 10 to 90%RH (no freezing or condensation)
Protection rating	IP20 (IEC standard)
Approval	CE
Unit weight (packaged)	\approx 320 g (\approx 470 g)
Comm. protocol	CC-Link Ver.1.10, Modbus RTU

EtherCAT Comm. Type

2-Phase Closed-Loop Stepper Motor System

AiC-EC Series



Features

- Closed-loop system with real-time position control
- High speed & high torque drive without missing steps
- Multi-axis simultaneous control with EtherCAT communication
- Windows-based software (atMotion) for easy parameter setting and monitoring
- 7-segment display for alarm / status reading
- Built-in brake type motors available (AiC-D-B-EC Series)

[Supported Motor*]

- Standard type: 20, 28, 35, 42, 56, 60 mm
- Built-in brake type: 42, 56, 60 mm
- Built-in gear type: 42, 60 mm
- Built-in rotary actuator type : 60 mm

Specifications

[Supported Driver]

Model	AiC-D-20□A-□-EC	AiC-D-28□B-EC	AiC-D-35□B-EC
Power supply	24 VDC \pm 10%		
Max. RUN power ⁰¹⁾	\leq 60 W		
Stop power ⁰²⁾	\leq 10 W		
Max. RUN current ⁰³⁾	0.6 A / Phase	1.0 A / Phase	1.2 A / Phase
Stop current	20 to 100% of max. RUN current		
Basic step angle	1.8° / Phase		
Resolution	500, 1000, 1600, 2000, 3600, 4000, 5000, 6400, 7200, 10000 (factory default) PPR	500, 1000, 1600, 2000, 3600, 5000, 6400, 7200, 10000 (factory default), 16000 PPR	

Model	AiC-D-42□A-□-EC	AiC-D-56□A-□-EC	AiC-D-60□A-□-EC
Power supply	24 VDC \pm 10%		
Max. RUN power ⁰¹⁾	\leq 60 W	\leq 120 W	\leq 240 W
Stop power ⁰²⁾	\leq 10 W	\leq 12 W	\leq 15 W
Max. RUN current ⁰³⁾	1.7 A / Phase	3.5 A / Phase	
Stop current	20 to 100% of max. RUN current		
Basic step angle	1.8° / Phase		
Resolution	500, 1000, 1600, 2000, 3200, 3600, 5000, 6400, 7200, 10000 (factory default) PPR		



01) When changing the load rapidly, instantaneous peak current may increase. The capacity of power supply should be over 1.5 to 2 times of max. RUN power.

02) Based on ambient temp. 25°C, ambient humi. 55%RH, stop current 50%

03) RUN current varies depending on the input RUN frequency and max. RUN current at the moment varies also.

Run method	2-phase bipolar closed-loop control method
Speed filter	Disable, 2, 4, 6, 8, 10, 20, 40, 60 (factory default), 80, 100, 120, 140, 160, 180, 200 ms
Control Gain	0 (factory default) to 15, (15: Fine Gain)
Max. rotation speed	3,000 rpm
In-Position	Fast Response: 0 (factory default) to 7, Accurate Response: 0 to 7
Operation mode	CSP, CSV, PP, PV, HM
Home search	Homing on the negative limit switch and index pulse Homing on the positive limit switch and index pulse Homing on the home switch and index pulse (Positive) Homing on the home switch and index pulse (Negative) Homing without an index pulse (negative limit switch) Homing without an index pulse (positive limit switch) Homing without an index pulse (Positive and Home sensor ON) Homing without an index pulse (Negative and Home sensor ON) Homing on the index pulse (Negative) Homing on the index pulse (Positive) Set the Origin with Home offset Set the Origin and Reset Current Position Torque Homing Search- with Home offset Torque Homing Search+ with Home offset

Next Page ►

I/O voltage level	[H]: 5 - 30 VDC≐, [L]: 0 - 2 VDC≐
Input	Exclusive input: 7, General input: 5
Output	Exclusive output: 2, General output: 4
External power supply	VEX (Default: 24 VDC≐), GEX (GND)
Insulation resistance	≥ 100 MΩ (500 VDC≐ megger)
Dielectric strength	1,000 VAC~ 60 Hz for 1 minute
Vibration	1.5 mm double amplitude at frequency 10 to 55 Hz (for 1 minute) in each X, Y, Z direction for 2 hours
Shock	300 m/s ² (≈ 30 G) in each X, Y, Z direction for 3 times
Ambient temp.	0 to 50°C, storage: -10 to 60°C (no freezing or condensation)
Ambient humi.	35 to 85%RH, storage: 10 to 90%RH (no freezing or condensation)
Protection rating	IP20 (IEC standard)
Approval	CE  
Unit weight (packaged)	≈ 350 g (≈ 500 g)
Comm. protocol	EtherCAT

AC Power Input

2-Phase Closed-Loop Stepper Motor System

AiCA Series



Features

- Closed-loop system with real-time position control
- High speed & high torque drive without missing steps
- Supports 200 - 240 VAC~ AC power
- Motor driver+Controller integrated type
- Control up to 31 axes with RS-485 communication
- Windows-based software (atMotion) for easy parameter setting and monitoring
- 4 operation mode: Jog mode, Continuous mode, Index mode, Program Mode
- 7 segment display for alarm / status reading
- Supports torque mode
- Supports Auto Current Down mode
- Built-in brake type motors available (AiCA-D-B Series)

[Supported Motor*]

- Standard type: 60, 86 mm
- Built-in brake type: 60, 86 mm
- Built-in gear type: 60, 86 mm
- Built-in rotary actuator type : 60 mm

Specifications

[Supported Driver]

Model	AiCA-D-60MA-□	AiCA-D-60LA-□	AiCA-D-86MA-□	AiCA-D-86LA-□
Main	Power supply	200 - 240 VAC~ 50 / 60 Hz		
	Max. RUN power ⁰¹⁾	≤ 800 VA		
	Stop power ⁰²⁾	≤ 60 VA		≤ 65 VA
AUX ⁰³⁾	Power supply	24 VDC≐		
	Input current	0.3 A		0.5 A
	Max. RUN current ⁰⁴⁾	2.0 A / Phase		
	Stop current	20 to 100% of max. RUN current		
	Resolution	500 (factory default), 1000, 1600, 2000, 3200, 3600, 5000, 6400, 7200, 10000 PPR		
	Run method	2-phase bipolar closed-loop control method		
	Speed filter	Disable, 2, 4, 6, 8, 10, 20, 40, 60 (factory default), 80, 100, 120, 140, 160, 180, 200 ms		
	Control Gain	0 (factory default) to 30, Fine Gain		
	Max. rotation speed	3000 rpm		
	Position setting range	-2,147,483,648 to +2,147,483,647		
	In-Position	Fast Response: 0 (factory default) to 7, Accurate Response: 0 to 7		
	Rotation direction	CW (factory default), CCW		
	Operation mode	Jog mode, Continuous mode, Index mode, Program mode		
	Home search mode	General mode, Limit mode, Zero point mode, Torque mode		
	Index step	64 step		
	Program step	256 step		
	Program function	Power On Program Start, Power On Home Search		
	Control command	ABS, INC, HOM, ICJ, IRD, OPC, OPT, JMP, REP, RPE, END, POS, TIM, CMP, TOQ		
	I/O voltage level	[H]: 5 - 30 VDC≐, [L]: 0 - 2 VDC≐		
	Input ⁰¹⁾	Exclusive input: 20, General input: 9		
	Output	Exclusive output: 4, General output: 10		
	External power supply	VEX (24 VDC≐ fixed): 2, GEX (GND): 2		
	Input resistance	4.7 kΩ (Anode Pull-up)		
	Insulation resistance	≥ 200 MΩ (500 VDC≐ megger)		
	Dielectric strength	1,500 VAC~ 60 Hz for 1 minute		
	Vibration	1.5 mm double amplitude at frequency 10 to 55 Hz (for 1 minute) in each X, Y, Z direction for 2 hours		
	Shock	300 m/s ² (≈ 30 G) in each X, Y, Z direction for 3 times		
	Ambient temp.	0 to 50°C, storage: -10 to 60°C (no freezing or condensation)		
	Ambient humi.	35 to 85%RH, storage: 10 to 90%RH (no freezing or condensation)		
	Protection rating	IP20 (IEC standard)		
	Approval	CE		
	Unit weight (packaged)	≈ 780 g (≈ 1,050 g)		
	Comm. protocol	Modbus RTU		

01) Brake ON/OFF function can be changed from general input IN8 in case of built-in brake type.

AC Power Input EtherCAT Comm. Type 2-Phase Closed-Loop Stepper Motor System

AiCA-EC Series



Features

- Closed-loop system with real-time position control
- High speed & high torque drive without missing steps
- Supports 200 - 240 VAC~ AC power
- Multi-axis simultaneous control with EtherCAT communication
- Windows-based software (atMotion) for easy parameter setting and monitoring
- 7-segment display for alarm / status reading
- Supports torque mode
- Supports Auto Current Down mode
- Built-in brake type motors available (AiCA-D-B-EC Series)
- Built-in geared / rotary actuator type motors available

[Supported Motor*]

- Standard type: 60, 86 mm
- Built-in brake type: 60, 86 mm
- Built-in gear type: 60, 86 mm
- Built-in rotary actuator type : 60 mm

Specifications

[Supported Driver]

Model	AiCA-D-60MA-□-EC	AiCA-D-60LA-□-EC	AiCA-D-86MA-□-EC	AiCA-D-86LA-□-EC	
Main power	Power supply	200 - 240 VAC~ 50/60 Hz			
	Max. RUN power ⁰¹⁾	≤ 800 VA			
	Stop power ⁰²⁾	≤ 60 VA		≤ 65 VA	
AUX power ⁰³⁾	Power supply	24 VDC≡			
	Input current	0.3 A		0.5 A	
Max. RUN current ⁰⁴⁾		2.0 A / Phase			
Stop current		20 to 100% of max. RUN current			
Resolution		500, 1000, 1600, 2000, 3200, 3600, 5000, 6400, 7200, 10000 (factory default) PPR			

01) When changing the load rapidly, instantaneous peak current may increase.

The capacity of power supply should be over 1.5 to 2 times of max. RUN power.

02) Based on ambient temp. 25 °C, ambient humi. 55 %RH, stop current 20%

03) Auxiliary power is only available in built-in brake type and not available in standard type.

04) RUN current varies depending on the input RUN frequency and max. RUN current at the moment varies also.

Run method	2-phase bipolar closed-loop control method
Speed filter	Disable, 2, 4, 6, 8, 10, 20, 40, 60(factory default), 80, 100, 120, 140, 160, 180, 200 ms
Control Gain	0 (factory default) to 31, (31: Fine Gain)
Max. rotation speed	3,000 rpm
In-Position	Fast Response: 0 to 7 (factory default), Accurate Response: 0 to 7
Operation mode	CSP, CSV, CST, PP, PV, HM
Home search	Homing on the negative limit switch and index pulse Homing on the positive limit switch and index pulse Homing on the home switch and index pulse (Positive) Homing on the home switch and index pulse (Negative) Homing without an index pulse (negative limit switch) Homing without an index pulse (positive limit switch) Homing without an index pulse (Positive and Home sensor ON) Homing without an index pulse (Negative and Home sensor ON) Homing on the index pulse (Negative) Homing on the index pulse (Positive) Set the Origin with Home offset Set the Origin and Reset Current Position Torque Homing Search- with Home offset Torque Homing Search+ with Home offset
Input	Exclusive input: 7, General input: 5
Output	Exclusive output: 2 General output: 4
External power supply	VEX (Default: 24 VDC≡), GEX (GND)
Input resistance	4.7 kΩ (Anode Pull-Up)
Insulation resistance	≥ 200 MΩ (500 VDC≡ megger)
Dielectric strength	1,500 VAC~ 60 Hz for 1 minute
Vibration	1.5 mm double amplitude at frequency 10 to 55 Hz (for 1 minute) in each X, Y, Z direction for 2 hours
Shock	300 m/s ² (≈ 30 G) in each X, Y, Z direction for 3 times
Ambient temp.	0 to 50°C, storage: -10 to 60°C (no freezing or condensation)
Ambient humi.	35 to 85%RH, storage: 10 to 90%RH (no freezing or condensation)
Protection rating	IP20 (IEC standard)
Approval	CE
Unit weight (packaged)	≈ 770 g (≈ 1,040 g)
Comm. protocol	EtherCAT

Standard / Built-In Brake Type 2-Phase Closed-Loop Stepper Motor

Ai-M / Ai-M-B Series



Features

- Supports □ 42 mm, □ 56 mm, □ 60 mm
- Non-excitation electromagnetic built-in brake type motor (Ai-M-B Series)

Specifications

Model	Ai-M-42SA-□	Ai-M-42MA-□	Ai-M-42LA-□
Max. stop torque	0.25 N m	0.4 N m	0.48 N m
Rotor inertia moment	35×10^{-7} kg · m ²	54×10^{-7} kg · m ²	77×10^{-7} kg · m ²
Rated current	1.7 A / Phase		
Basic step angle	1.8° / 0.9° (Full / Half step)		
Resistance	1.7 Ω / Phase ±10%	1.85 Ω / Phase ±10%	2.1 Ω / Phase ±10%
Inductance	1.9 mH / Phase ±20%	3.5 mH / Phase ±20%	4.4 mH / Phase ±20%
Unit weight (packaged) ⁰¹⁾	≈ 0.34 kg (≈ 0.45 kg) ≈ 0.67 kg (≈ 0.77 kg)	≈ 0.41 kg (≈ 0.52 kg) ≈ 0.73 kg (≈ 0.83 kg)	≈ 0.48 kg (≈ 0.59 kg) ≈ 0.80 kg (≈ 0.90 kg)

Model	Ai-M-56SA-□	Ai-M-56MA-□	Ai-M-56LA-□
Max. stop torque	0.6 N m	1.2 N m	2.0 N m
Rotor inertia moment	140×10^{-7} kg · m ²	280×10^{-7} kg · m ²	480×10^{-7} kg · m ²
Rated current	3.5 A / Phase		
Basic step angle	1.8° / 0.9° (Full / Half step)		
Resistance	0.55 Ω / Phase ±10%	0.57 Ω / Phase ±10%	0.93 Ω / Phase ±10%
Inductance	1.05 mH / Phase ±20%	1.8 mH / Phase ±20%	3.7 mH / Phase ±20%
Unit weight (packaged) ⁰¹⁾	≈ 0.62 kg (≈ 0.76 kg) ≈ 1.15 kg (≈ 1.30 kg)	≈ 0.85 kg (≈ 0.99 kg) ≈ 1.38 kg (≈ 1.52 kg)	≈ 1.22 kg (≈ 1.36 kg) ≈ 1.75 kg (≈ 1.90 kg)

Model	Ai-M-60SA-□	Ai-M-60MA-□	Ai-M-60LA-□
Max. stop torque	1.1 N m	2.2 N m	2.9 N m
Rotor inertia moment	240×10^{-7} kg · m ²	490×10^{-7} kg · m ²	690×10^{-7} kg · m ²
Rated current	3.5 A / Phase		
Basic step angle	1.8° / 0.9° (Full / Half step)		
Resistance	1.0 Ω / Phase ±10%	1.23 Ω / Phase ±10%	1.3 Ω / Phase ±10%
Inductance	1.5 mH / Phase ±20%	2.6 mH / Phase ±20%	3.8 mH / Phase ±20%
Unit weight (packaged) ⁰¹⁾	≈ 0.75 kg (≈ 0.89 kg) ≈ 1.36 kg (≈ 1.53 kg)	≈ 1.13 kg (≈ 1.27 kg) ≈ 1.74 kg (≈ 1.90 kg)	≈ 1.44 kg (≈ 1.58 kg) ≈ 2.07 kg (≈ 2.23 kg)

01) Listed in order of

Standard type	Built-in brake type
---------------	---------------------

Motor phase	2-phase
RUN method	Bipolar
Insulation class	B type (130°C)
Insulation resistance	Between motor coil and case: ≥ 100 MΩ (500 VDC= megger)
Dielectric strength	Between motor coil and case: 500 VAC ~ 50 / 60 Hz for 1 minute
Vibration	1.5 mm double amplitude at frequency 10 to 55 Hz (for 1 minute) in each X, Y, Z direction for 2 hours
Shock	≤ 50 G
Ambient temp.	0 to 50°C, storage: -20 to 70°C (no freezing or condensation)
Ambient humi.	20 to 85%RH, storage: 15 to 90%RH (no freezing or condensation)
Protection rating	IP30 (IEC34-5 standard)
Approval	CE ENEC
Stop angle error	± 0.09° (Full step, no load)
Shaft vibration	0.03 mm T.I.R.
Radial movement ⁰¹⁾	≤ 0.025 mm T.I.R.
Axial movement ⁰²⁾	≤ 0.01 mm T.I.R.
Shaft concentricity	0.05 mm T.I.R.
Shaft perpendicularity	0.075 mm T.I.R.

01) Amount of radial shaft displacement when applying radial load (25 N) to the end of the shaft.
02) Amount of axial shaft displacement when applying axial load (50 N) to the motor shaft.

Next Page ▶

Encoder type	Incremental rotary encoder		
Power supply	5 VDC \pm 5% (ripple P-P: \leq 5%)		
Current consumption	\leq 50 mA (no load)		
Resolution	10,000 PPR (2,500 PPR \times 4)		
Control output	Line driver output		
Output phase	A, \bar{A} , B, \bar{B} , Z, \bar{Z}		
Output waveform	Output duty rate: $\frac{T}{2} \pm \frac{T}{4}$, A-B phase difference: $\frac{T}{4} \pm \frac{T}{8}$ (T = 1 cycle of A)		
Inflow current	\leq 20 mA		
Residual voltage	\leq 0.5 VDC \pm		
Outflow current	\leq -20 mA		
Output voltage	\geq 2.5 VDC \pm		
Response speed	\leq 0.5 μ s (based on cable length: 2 m, I sink = 20 mA)		
Max. response freq.	300 kHz		
Built-in brake type frame size	<input type="checkbox"/> 42 mm	<input type="checkbox"/> 56 mm	<input type="checkbox"/> 60 mm
Rated excitation voltage <small>01)</small>	24 VDC \pm \pm 10%		
Rated excitation current	0.208 A	0.275 A	
Static friction torque	\geq 0.18 N m	\geq 0.8 N m	
Rotation part inertia moment	6×10^{-7} kg \cdot m ²	19×10^{-7} kg \cdot m ²	
Insulation class	B type (130°C)		
B type brake	Brake is released when power ON, brake is locked when power OFF		
Operating time	\leq 25 ms	\leq 30 ms	
Releasing time	\leq 10 ms	\leq 20 ms	

01) In order to reduce the heat generation of the built-in brake, the voltage drops from 24 VDC \pm to 11.5 VDC \pm to control.

Standard Type

2-Phase Closed-Loop Stepper Motor

Ai-M Series



Features

- Supports □ 20 mm, □ 28 mm, □ 35 mm

Specifications

Model	Ai-M-20MA	Ai-M-20LA	
Max. stop torque	0.018 N m	0.035 N m	
Rotor inertia moment	$2 \times 10^{-7} \text{ kg} \cdot \text{m}^2$		
Rated current	0.6 A / Phase		
Basic step angle	1.8° / 0.9° (Full / Half step)		
Resistance	6.6 Ω / Phase ±10%	10.5 Ω / Phase ±10%	
Inductance	2.1 mH / Phase ±20%	4.0 mH / Phase ±20%	
Unit weight (packaged)	≈ 0.092 kg (≈ 0.192 kg)	≈ 0.120 kg (≈ 0.219 kg)	
Model	Ai-M-28SB	Ai-M-28MB	Ai-M-28LB
Max. stop torque	0.05 N m	0.14 N m	0.16 N m
Rotor inertia moment	$9 \times 10^{-7} \text{ kg} \cdot \text{m}^2$	$12 \times 10^{-7} \text{ kg} \cdot \text{m}^2$	$18 \times 10^{-7} \text{ kg} \cdot \text{m}^2$
Rated current	1.0 A / Phase		
Basic step angle	1.8° / 0.9° (Full / Half step)		
Resistance	5.78 Ω / Phase ±10%	8.8 Ω / Phase ±10%	10.1 Ω / Phase ±10%
Inductance	3.2 mH / Phase ±20%	6.0 mH / Phase ±20%	6.2 mH / Phase ±20%
Unit weight (packaged)	≈ 0.162 kg (≈ 0.260 kg)	≈ 0.222 kg (≈ 0.318 kg)	≈ 0.248 kg (≈ 0.342 kg)
Model	Ai-M-35SB	Ai-M-35MB	Ai-M-35LB
Max. stop torque	0.07 N m	0.13 N m	0.31 N m
Rotor inertia moment	$8 \times 10^{-7} \text{ kg} \cdot \text{m}^2$	$14 \times 10^{-7} \text{ kg} \cdot \text{m}^2$	$22 \times 10^{-7} \text{ kg} \cdot \text{m}^2$
Rated current	1.2 A / Phase		
Basic step angle	1.8° / 0.9° (Full / Half step)		
Resistance	2.1 Ω / Phase ±10%	3.25 Ω / Phase ±10%	5.0 Ω / Phase ±10%
Inductance	1.25 mH / Phase ±20%	2.85 mH / Phase ±20%	5.6 mH / Phase ±20%
Unit weight (packaged)	≈ 0.180 kg (≈ 0.278 kg)	≈ 0.250 kg (≈ 0.347 kg)	≈ 0.366 kg (≈ 0.456 kg)
Motor phase	2-phase		
Run method	Bipolar		
Insulation class	B type (130°C)		
Insulation resistance	Between motor coil and case: ≥ 100 MΩ (500 VDC= megger)		
Dielectric strength	Between motor coil and case: 500 VAC~ 50 / 60 Hz for 1 minute		
Vibration	1.5 mm double amplitude at frequency 10 to 55 Hz (for 1 minute) in each X, Y, Z direction for 2 hours		
Shock	≤ 50 G		
Ambient temp.	0 to 50°C, storage: -20 to 70°C (no freezing or condensation)		
Ambient humi.	20 to 85%RH, storage: 15 to 90%RH (no freezing or condensation)		
Protection rating	IP30 (IEC34-5 standard)		
Approval	CE EAC		
Stop angle error	± 0.09° (Full step, no load)		
Shaft vibration	0.03 mm T.I.R.		
Radial movement ⁰¹⁾	≤ 0.025 mm T.I.R.		
Axial movement ⁰²⁾	≤ 0.005 mm T.I.R.		
Shaft concentricity	0.05 mm T.I.R.		
Shaft perpendicularity	0.075 mm T.I.R.		

01) Amount of radial shaft displacement when adding a radial load (450 g) to the top of the shaft.
02) Amount of radial shaft displacement when adding an axial load (920 g) to the shaft.

Next Page ►

Encoder type	Incremental Rotary Encoder		
Frame size	<input type="checkbox"/> 20 mm	<input type="checkbox"/> 28 mm	<input type="checkbox"/> 35 mm
Power supply	5 VDC \pm 5% (ripple P-P: \leq 5%)		
Current consumption	\leq 50 mA (No load)		
Resolution	4,000 PPR (1,000 PPR \times 4)	16,000 PPR (4,000 PPR \times 4)	
Control output	Line driver Output		
Output phase	A, \bar{A} , B, \bar{B} , Z, \bar{Z}		
Output waveform	Output phase: $\frac{T}{2} \pm \frac{T}{3}$, A-B phase difference: $\frac{T}{4} \pm \frac{T}{4}$ (T = 1 cycle of A)		
Inflow current	\leq 20 mA		
Residual voltage	\leq 0.5 VDC \pm		
Outflow current	\leq -20 mA		
Output voltage	\geq 2.5 VDC \pm		
Response speed ⁰¹⁾	\leq 1.5 μ s	\leq 1 μ s	
Max. response freq.	200 kHz	1,000 kHz	

01) Cable length: 2 m, I sink = 20 mA

Built-In Gear / Rotary Actuator Type 2-Phase Closed-Loop Stepper Motor

Ai-M-G / Ai-M-R Series



Features

- Built-in planetary gear type motor (Ai-M-G)
- Built-in rotary actuator type motor (Ai-M-R)
- Supports □ 42 mm, □ 60 mm

Specifications

Model	Ai-M-42MA-G5	Ai-M-42MA-G7.2	Ai-M-42MA-G10
Max. stop torque	1.5 N m	2 N m	2 N m
Rotor inertia moment	54×10 ⁻⁷ kg · m ²		
Rated current	1.7 A / Phase		
Allowable torque	1 N m	1.5 N m	1.5 N m
Standard step angle	0.36°	0.25°	0.18°
Backlash	35 min (0.58°)		
Resistance	1.85 Ω / Phase ±10%		
Inductance	3.5 mH / Phase ±20%		
Unit weight (packaged)	≈ 0.58 kg (≈ 0.70 kg)		

Model	Ai-M-60MA-□5	Ai-M-60MA-□7.2	Ai-M-60MA-□10
Max. stop torque	7 N m	9 N m	11 N m
Rotor inertia moment	490×10 ⁻⁷ kg · m ²		
Rated current	3.5 A / Phase		
Allowable torque	5 N m	6 N m	7 N m
Standard step angle	0.36°	0.25°	0.18°
Backlash	35 min (0.58°)		
Resistance	1.23 Ω / Phase ±10%		
Inductance	2.6 mH / Phase ±20%		
Unit weight (packaged)	≈ 1.52 kg (≈ 1.68 kg)		
	≈ 1.60 kg (≈ 1.76 kg)		

01) Listed in order of $\frac{\text{Built-in gear type}}{\text{Built-in rotary actuator type}}$

Motor phase	2-phase
Run method	Bipolar
Insulation class	B type (130°C)
Insulation resistance	Between motor coil and case: ≥ 100 MΩ (500 VDC≡ megger)
Dielectric strength	Between motor coil and case: 500 VAC~ 50 / 60 Hz for 1 minute
Vibration	1.5 mm double amplitude at frequency 10 to 55 Hz (for 1 minute) in each X, Y, Z direction for 2 hours
Shock	≤ 50 G
Ambient temp.	0 to 50°C, storage: -20 to 70°C (no freezing or condensation)
Ambient humi.	20 to 85%RH, storage: 15 to 90%RH (no freezing or condensation)
Protection rating	IP30 (IEC standard)
Approval	CE
Stop angle error	± 0.09° (Full step, no load)
Shaft vibration	0.03 mm T.I.R.
Radial Movement ⁰¹⁾	≤ 0.025 mm T.I.R.
Axial Movement ⁰²⁾	≤ 0.01 mm T.I.R.
Shaft concentricity	0.05 mm T.I.R.
Shaft perpendicularity	0.075 mm T.I.R.

01) Amount of radial shaft displacement when applying radial load (25 N) to the end of the motor shaft
02) Amount of axial shaft displacement when applying axial load (50 N) to the motor shaft

Next Page ►

Encoder type	Incremental Rotary Encoder
Power supply	5 VDC \pm 5% (ripple P-P: \leq 5%)
Current consumption	\leq 50 mA (no load)
Resolution	10,000 PPR (2,500 PPR \times 4-multiply)
Control output	Line driver output
Output phase	A, \bar{A} , B, \bar{B} , Z, \bar{Z}
Output waveform	Output duty rate: $\frac{T}{2} \pm \frac{T}{4}$, A-B phase difference $\frac{T}{4} \pm \frac{T}{8}$ (T = 1 cycle of A)
Inflow current	\leq 20 mA
Residual voltage	\leq 0.5 VDC \pm
Outflow current	\leq -20 mA
Output voltage	\geq 2.5 VDC \pm
Response speed	\leq 0.5 μ s (based on cable length: 2 m, I sink = 20 mA)
Max. response frequency	300 kHz

Standard / Built-In Brake Type AC Power Input 2-Phase Closed-Loop Stepper Motor

AiA-M / AiA-M-B Series



Features

- Supports □ 60 mm, □ 86 mm
- Non-excitation electromagnetic built-in brake type Motor (AiA-M-B Series)

Specifications

Model	AiA-M-60MA-□	AiA-M-60LA-□
Max. stop torque	1.1 N m	2.2 N m
Rotor inertia moment	$240 \times 10^{-7} \text{ kg} \cdot \text{m}^2$	$490 \times 10^{-7} \text{ kg} \cdot \text{m}^2$
Rated current	2.0 A / Phase	
Basic step angle	1.8° / 0.9° (Full / Half step)	
Resistance	1.5 Ω / Phase ±10%	2.4 Ω / Phase ±10%
Inductance	3.9 mH / Phase ±20%	8.5 mH / Phase ±20%
Unit weight (packaged) ⁰¹⁾	≈ 0.75 kg (≈ 0.95 kg) ≈ 1.35 kg (≈ 1.53 kg)	≈ 1.15 kg (≈ 1.35 kg) ≈ 1.75 kg (≈ 1.90 kg)
Model	AiA-M-86MA-□	AiA-M-86LA-□
Max. stop torque	2.8 N m	4.0 N m
Rotor inertia moment	$1,100 \times 10^{-7} \text{ kg} \cdot \text{m}^2$	$1,800 \times 10^{-7} \text{ kg} \cdot \text{m}^2$
Rated current	2.0 A / Phase	
Basic step angle	1.8° / 0.9° (Full / Half step)	
Resistance	2.3 Ω / Phase ±10%	1.9 Ω / Phase ±10%
Inductance	11.5 mH / Phase ±20%	16.2 mH / Phase ±20%
Unit weight (packaged) ⁰¹⁾	≈ 1.70 kg (≈ 2.00 kg) ≈ 2.50 kg (≈ 2.76 kg)	≈ 2.30 kg (≈ 2.60 kg) ≈ 3.10 kg (≈ 3.36 kg)

01) Listed in order of

Standard type		Built-in brake type
---------------	--	---------------------

Motor phase	2-phase
Run method	Bipolar
Insulation class	B type (130°C)
Insulation resistance	Between motor coil and case: $\geq 100 \text{ M}\Omega$ (500 VDC≡ megger)
Dielectric strength	Between motor coil and case: 1,000 VAC~ 50 / 60 Hz for 1 minute
Vibration	1.5 mm double amplitude at frequency 10 to 55 Hz (for 1 minute) in each X, Y, Z direction for 2 hours
Shock	$\leq 50 \text{ G}$
Ambient temp.	0 to 50°C, storage: -20 to 70°C (no freezing or condensation)
Ambient humi.	20 to 85%RH, storage: 15 to 90%RH (no freezing or condensation)
Protection rating	IP30 (IEC34-5 standard)
Approval	CE
Stop angle error	$\pm 0.09^\circ$ (Full step, no load)
Shaft vibration	0.03 mm T.I.R.
Radial movement ⁰¹⁾	$\leq 0.025 \text{ mm}$ T.I.R.
Axial movement ⁰²⁾	$\leq 0.01 \text{ mm}$ T.I.R.
Shaft concentricity	0.05 mm T.I.R.
Shaft perpendicularity	0.075 mm T.I.R.

01) Amount of radial shaft displacement when applying radial load (25 N) to the end of the shaft.
02) Amount of axial shaft displacement when applying axial load (50 N) to the shaft.

Next Page ►

Encoder type	Incremental Rotary Encoder	
Power supply	5 VDC \pm 5% (ripple P-P: \leq 5%)	
Current consumption	\leq 50 mA (No load)	
Resolution	10,000 PPR (2,500 PPR \times 4)	
Control output	Line driver Output	
Output phase	A, \bar{A} , B, \bar{B} , Z, \bar{Z}	
Output waveform	Output Duty rate: $\frac{T}{2} \pm \frac{T}{4}$, A-B phase difference: $\frac{T}{4} \pm \frac{T}{8}$ (T = 1 cycle of A)	
Inflow current	\leq 20 mA	
Residual voltage	\leq 0.5 VDC \pm	
Outflow current	\leq -20 mA	
Output voltage	\geq 2.5 VDC \pm	
Response speed	\leq 0.5 μ s (Cable length: 2 m, I sink = 20 mA)	
Max. response freq.	300 kHz	
Built-in brake type frame size	<input type="checkbox"/> 60 mm	<input type="checkbox"/> 86 mm
Rated excitation voltage	24 VDC \pm 10%	
Rated excitation current	0.275 A	0.479 A
Static friction torque	0.75 N m	2.6 N m
Rotation part inertia moment	1.9×10^{-6} kg \cdot m ²	12×10^{-6} kg \cdot m ²
Insulation class	B type (130°C)	
B type brake	Brake is released when power ON, brake is locked when power OFF	
Operating time	30 ms	40 ms
Releasing time	10 ms	25 ms

Built-In Gear / Rotary Actuator Type AC Power Input 2-Phase Closed-Loop Stepper Motor

AiA-M-G / AiA-M-R Series



Features

- Built-in planetary gear type motor (AiA-M-G)
- Built-in rotary actuator type motor (AiA-M-R)
- Supports □ 60 mm, □ 86 mm

Specifications

Model	AiA-M-60LA-□5	AiA-MA-60LA-□7.2	AiA-MA-60LA-□10
Max. stop torque	7 N m	9 N m	11 N m
Rotor inertia moment	490×10 ⁻⁷ kg · m ²		
Rated current	2.0 A / Phase		
Allowable torque	5 N m	6 N m	7 N m
Standard step angle	0.36°	0.25°	0.18°
Backlash	35 min (0.58°)		
Resistance	2.4 Ω / Phase ±10%		
Inductance	8.5 mH / Phase ±20%		
Unit weight (packaged) ⁰¹⁾	≈ 1.54 kg (≈ 1.70 kg)		
	≈ 1.62 kg (≈ 1.78 kg)		

01) Listed in order of $\frac{\text{Built-in gear type}}{\text{Built-in rotary actuator type}}$

Model	AiA-M-86LA-G5	AiA-M-86LA-G7.2	AiA-M-86LA-G10
Max. stop torque	20 N m	28 N m	35 N m
Rotor inertia moment	1800×10 ⁻⁷ kg m ²		
Rated current	2.0 A / Phase		
Allowable torque	14 N m	20 N m	20 N m
Standard step angle	0.36°	0.25°	0.18°
Backlash	35 min (0.58°)		
Resistance	1.9 Ω / Phase ±10%		
Inductance	16.2 mH / Phase ±20%		
Unit weight (packaged)	≈ 3,700 kg (≈ 3,950 kg)		
Motor phase	2-phase		
Run method	Bipolar		
Insulation class	B type (130°C)		
Insulation resistance	Between motor coil and case: ≥ 100 MΩ (500 VDC= megger),		
Dielectric strength	Between motor coil and case: 1,000 VAC ~ 50 / 60 Hz for 1 minute		
Vibration	1.5 mm double amplitude at frequency 10 to 55 Hz (for 1 minute) in each X, Y, Z direction for 2 hours		
Shock	≤ 50 G		
Ambient temp.	0 to 50°C, storage: -20 to 70°C (no freezing or condensation)		
Ambient humi.	20 to 85%RH, storage: 15 to 90%RH (no freezing or condensation)		
Protection rating	IP30 (IEC standard)		
Approval	CE		
Stop angle error	± 0.09° (Full step, no load)		
Shaft vibration	0.05 mm T.I.R.		
Radial Movement ⁰¹⁾	≤ 0.025 mm T.I.R.		
Axial Movement ⁰²⁾	≤ 0.01 mm T.I.R.		
Shaft concentricity	0.075 mm T.I.R.		
Shaft perpendicularity	0.075 mm T.I.R.		

01) Amount of radial shaft displacement when applying radial load (25 N) to the end of the motor shaft
02) Amount of axial shaft displacement when applying axial load (50 N) to the motor shaft

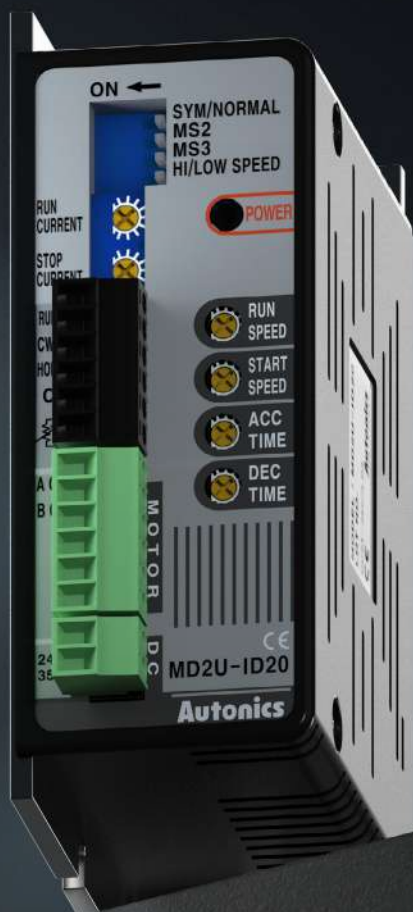

G2. 2-Phase Stepper Motor Drivers

Stepper motor drivers receive pulse signals from a controlling unit such as a motion controller and transmits electric currents to motors.

G2-1	2-Phase Stepper Motor Drivers	MD2U-ID20 Series	Intelligent Type 2-Phase Stepper Motor Drivers
		MD2U-MD20 Series	Micro Step 2-Phase Stepper Motor Drivers

Intelligent Type 2-Phase Stepper Motor Drivers

MD2U-ID20 Series



Features

- Unipolar constant current drive method
- STOP current setting provides holding torque (brake function)
- Isolated photocoupler input design minimizes influence from electrical noise
- Power supply Range: 24 - 35 VDC \pm

Specifications

Model	MD2U-ID20
Power supply ⁰¹⁾	24 - 35 VDC \pm \pm 10%
Max. current consumption	3 A (based on ambient temp. 25°C, ambient humi. 55%RH)
RUN current ⁰²⁾	0.5 - 2 A / Phase
STOP current	20 to 70% of RUN current (set by STOP current setting rotary switch)
RUN method	Unipolar constant current drive
Standard step angle	1.8° / Step
Max. RUN speed	1500 rpm
Input resistance	3.3 k Ω (CW/CCW, RUN/STOP, HOLD OFF)
Insulation resistance	Between all terminal and case: \geq 200 M Ω (500 VDC \pm megger)
Dielectric strength	Between all terminal and case: 1,000 VAC \sim 50 / 60 Hz for 1 minute
Noise immunity	\pm 500 VDC \pm square wave noise (pulse width: 1 μ s) by the noise simulator
Vibration	1.5 mm double amplitude at frequency 10 to 55 Hz (for 1 minute) in each X, Y, Z direction for 2 hours
Shock	300 m/s ² (\approx 30 G) in each X, Y, Z direction for 3 times
Ambient temp.	0 to 50°C, storage: -10 to 60°C (no freezing or condensation)
Ambient humi.	35 to 85% RH, storage: 35 to 85% RH (no freezing or condensation)
Approval	CE [REDACTED]
Unit weight (packaged)	\approx 109 g (\approx 303 g)

01) If a power supply is over 30 VDC \pm , the torque characteristics in the high speed range will improve, but the driver's temperature will increase as well. Install the unit in well-ventilated area.

02) RUN current varies depending on the RUN frequency, and the max. instantaneous RUN current varies depending on load.

Micro Step

2-Phase Stepper

Motor Drivers

MD2U-MD20 Series



Features

- Unipolar constant current drive method
- STOP current setting provides holding torque (brake function)
- Low vibration operation with micro stepping drive
- Isolated photocoupler input design minimizes influence from electrical noise
- Power supply Range: 24 - 35 VDC \pm

Specifications

Model	MD2U-MD20
Power supply ⁰¹⁾	24 - 35 VDC \pm \pm 10%
Max. current consumption	3 A (based on ambient temp. 25°C, ambient humi. 55%RH)
RUN current ⁰²⁾	0.5 - 2 A / Phase
STOP current	20 to 70% of RUN current (set by stop current setting rotary switch)
RUN method	Unipolar constant current drive
Basic step angle	1.8° / Step
Resolution	1, 2, 4, 5, 8, 10, 16, 20 division (1.8° to 0.09° / Step)
Pulse width	\geq 10 μ s (CW / CCW), 1 ms (HOLD OFF)
Duty rate	50% (CW / CCW)
Rise, Fall time	\leq 0.5 μ s (CW / CCW)
Pulse input voltage	[H]: 4 - 8 VDC \pm , [L]: 0 - 0.5 VDC \pm
Pulse input current	4 mA (CW / CCW), 10 mA (HOLD OFF)
Max. input pulse frequency	\leq 50 kHz (CW / CCW)
Input resistance	300 Ω (CW / CCW), 390 Ω (HOLD OFF)
Insulation resistance	Between all terminal and case: \geq 200 M Ω (500 VDC \pm megger)
Dielectric strength	Between all terminal and case: 1,000 VAC \sim 50 / 60 Hz for 1 minute
Noise immunity	\pm 500 VDC \pm square wave noise (pulse width: 1 μ s) by the noise simulator
Vibration	1.5 mm double amplitude at frequency 10 to 55 Hz (for 1 minute) in each X, Y, Z direction for 2 hours
Shock	300 m/s ² (\approx 30 G) in each X, Y, Z direction for 3 times
Ambient temp.	0 to 50°C, storage: -10 to 60°C (no freezing or condensation)
Ambient humi.	35 to 85% RH, storage: 35 to 85% RH (no freezing or condensation)
Approval	CE ENEC
Unit weight (packaged)	\approx 180 g (\approx 295 g)

01) If a power supply is over 30 VDC \pm , the torque characteristics in the high speed range will improve, but the driver's temperature will increase as well. Install the unit in well-ventilated area. The torque may vary depending on power supply.

02) RUN current varies depending on the RUN frequency, and the max. instantaneous RUN current varies depending on load.



G3. 5-Phase Stepper Motor & Drivers

Stepper motors are electric motors which rotate by converting electric current from motor drivers into equally divided steps of a full rotation.

G

G3-1	5-Phase Stepper Motors	AK Series	Standard / Built-In Brake Type 5-Phase Stepper Motors (□ 24 / 42 / 60 / 85 mm)
		AHK Series	Hollow Shaft Type 5-Phase Stepper Motor (□ 42 / 60 / 85 mm)
		AK-G / AK-R Series	Built-In Gear / Rotary Actuator Type 5-Phase Stepper Motors (□ 42 / 60 / 85 mm)
G3-2	5-Phase Stepper Drivers	MD5-HD14 Series	Micro Step 5-Phase Stepper Motor Drivers
		MD5-HF14 Series	Micro Step 5-Phase Stepper Motor Drivers
		MD5-HF14-AO Series	Micro Step 5-Phase Stepper Motor Drivers
		MD5-HF28 Series	Micro Step 5-Phase Stepper Motor Drivers
		MD5-ND14 Series	Micro Step 5-Phase Stepper Motor Drivers
		MD5-HD14-2X / MD5-HD14-3X Series	Micro Step 5-Phase Stepper Motor Drivers

Standard / Built-In Brake Type 5-Phase Stepper Motors

(□ 24 / 42 / 60 / 85 mm)

AK Series



Features

- Compact and light weight with high accuracy, high speed and high torque
- Ideal for building compact sized system
- Low price for improved cost efficiency
- In pursuit of compact equipment applied with □ 42 mm, □ 60 mm, □ 85 mm built-in brake type (AK-B Series)
- Brake releases when power is applied on brake wire (AK-B Series)

Specifications

Model	02K-S523□	04K-S525□	
Max. stop torque	0.18 kgf cm (0.018 N m)	0.28 kgf cm (0.028 N m)	
Rotor inertia moment	4.2×10^{-7} kg · m ²	8.2×10^{-7} kg · m ²	
Rated current	0.75 A / Phase		
Basic step angle	0.72° / 0.36° (Full / Half step)		
Unit weight (packaged)	≈ 0.08 kg (≈ 0.10 kg)	≈ 0.12 kg (≈ 0.16 kg)	
Model	A1K-S543□-□	A2K-S544□-□	A3K-S545□-□
Max. stop torque	1.3 kgf cm (0.13 N m)	1.8 kgf cm (0.18 N m)	2.4 kgf cm (0.24 N m)
Rotor inertia moment	35×10^{-7} kg · m ²	54×10^{-7} kg · m ²	68×10^{-7} kg · m ²
Rated current	0.75 A / Phase		
Basic step angle	0.72° / 0.36° (Full / Half step)		
Unit weight (packaged) ⁰¹⁾	≈ 0.25 kg (≈ 0.34 kg) ≈ 0.39 kg (≈ 0.44 kg)	≈ 0.30 kg (≈ 0.39 kg) ≈ 0.44 kg (≈ 0.49 kg)	≈ 0.40 kg (≈ 0.49 kg) ≈ 0.54 kg (≈ 0.59 kg)
Model	A4K-□564□-□	A8K-□566□-□	A16K-□569□-□
Max. stop torque	4.2 kgf cm (0.42 N m)	8.3 kgf cm (0.83 N m)	16.6 kgf cm (1.66 N m)
Rotor inertia moment	175×10^{-7} kg · m ²	280×10^{-7} kg · m ²	560×10^{-7} kg · m ²
Rated current	S: 0.75 A / Phase M: 1.4 A / Phase G: 2.8 A / Phase		
Basic step angle	0.72° / 0.36° (Full / Half step)		
Unit weight (packaged) ⁰¹⁾	≈ 0.60 kg (≈ 0.85 kg) ≈ 0.95 kg (≈ 1.03 kg)	≈ 0.80 kg (≈ 1.05 kg) ≈ 1.25 kg (≈ 1.33 kg)	≈ 1.30 kg (≈ 1.55 kg) ≈ 1.65 kg (≈ 1.73 kg)
Model	A21K-□596□-□	A41K-□599□-□	A63K-□5913□-□
Max. stop torque	21 kgf cm (2.1 N m)	41 kgf cm (4.1 N m)	63 kgf cm (6.3 N m)
Rotor inertia moment	$1,400 \times 10^{-7}$ kg · m ²	$2,700 \times 10^{-7}$ kg · m ²	$4,000 \times 10^{-7}$ kg · m ²
Rated current	M: 1.4 A / Phase G: 2.8 A / Phase		
Basic step angle	0.72° / 0.36° (Full / Half step)		
Unit weight (packaged) ⁰¹⁾	≈ 1.70 kg (≈ 2.15 kg) ≈ 2.64 kg (≈ 2.74 kg)	≈ 2.80 kg (≈ 3.25 kg) ≈ 3.74 kg (≈ 3.84 kg)	≈ 3.80 kg (≈ 4.25 kg) ≈ 4.74 kg (≈ 4.84 kg)

01) Listed in order of

Standard type	Built-in brake type
---------------	---------------------

Motor phase	5-phase
Insulation class	B type (130°C)
Insulation resistance	Between motor coil and case: $\geq 100 \text{ M}\Omega$ (500 VDC= megger)
Dielectric strength ⁰¹⁾	Between motor coil and case: 1,000 VAC~ 50 / 60 Hz for 1 minute
Temperature rise	$\leq 80^\circ\text{C}$ (5-phase excitation for rated current, while stop)
Ambient temp.	-10 to 50°C, storage: -25 to 85°C (no freezing or condensation)
Ambient humi.	35 to 85%RH, storage: 35 to 85%RH (no freezing or condensation)
Protection rating	IP30 (IEC34-5 standard)
Approval	CE ENEC
Stop angle error	$\pm 3'$ ($\pm 0.05^\circ$) (Full step, no load)
Shaft vibration	0.05 mm T.I.R.
Radial movement ⁰²⁾	$\leq 0.025 \text{ mm}$ T.I.R.
Axial movement ⁰³⁾	$\leq 0.075 \text{ mm}$ T.I.R.
Shaft concentricity	0.075 mm T.I.R.
Shaft perpendicularity	0.075 mm T.I.R.

01) In case of rated current: 0.75 A / Phase, Between motor coil and case: 500 VAC~ 50 / 60 Hz for 1 minute

02) Amount of radial shaft displacement when applying radial load (5 N) to the end of the shaft.

03) Amount of axial shaft displacement when applying axial load (10 N) to the shaft.

Built-in brake type Frame size	<input type="checkbox"/> 42 mm	<input type="checkbox"/> 60 mm	<input type="checkbox"/> 85 mm
Rated excitation voltage	24 VDC= $\pm 10\%$		
Rated excitation current	0.2 A	0.33 A	0.62 A
Static friction torque	$\geq 0.18 \text{ N}\cdot\text{m}$	$\geq 0.8 \text{ N}\cdot\text{m}$	$\geq 4.0 \text{ N}\cdot\text{m}$
Rotation part inertia moment	$3 \times 10^{-7} \text{ kg} \cdot \text{m}^2$	$29 \times 10^{-7} \text{ kg} \cdot \text{m}^2$	$153 \times 10^{-7} \text{ kg} \cdot \text{m}^2$
Insulation class	B type (130°C)		
B type brake	Brake is released when power ON, brake is locked when power OFF		
Operating time	$\leq 25 \text{ ms}$	$\leq 25 \text{ ms}$	$\leq 60 \text{ ms}$
Releasing time	$\leq 15 \text{ ms}$	$\leq 20 \text{ ms}$	$\leq 15 \text{ ms}$

Hollow Shaft Type

5-Phase Stepper Motors

(□ 42 / 60 / 85 mm)

AHK Series

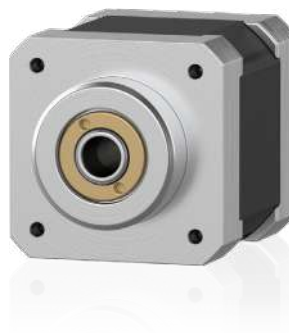

Features

- Direct connection of Ball-screw, TM-screw and etc. without couplings
- No resonance (vibration, noise) due to removed coupling
- Low cost of applied system by improving the coupling accuracy and reducing the number of parts and installation process
- Compact and light weight with high accuracy, high speed and high torque
- Ideal for building compact sized system

Specifications

Model	AH1K-S543-□	AH2K-S544-□	AH3K-S545-□
Max. stop torque	1.3 kgf cm (0.13 N m)	1.8 kgf cm (0.18 N m)	2.4 kgf cm (0.24 N m)
Rotor inertia moment	$35 \times 10^{-7} \text{ kg} \cdot \text{m}^2$	$54 \times 10^{-7} \text{ kg} \cdot \text{m}^2$	$68 \times 10^{-7} \text{ kg} \cdot \text{m}^2$
Rated current	0.75 A / Phase		
Basic step angle	0.72° / 0.36° (Full / Half step)		
Unit weight (packaged)	≈ 0.25 kg (≈ 0.35 kg)	≈ 0.30 kg (≈ 0.40 kg)	≈ 0.40 kg (≈ 0.50 kg)
Model	AH4K-□564□-□	AH8K-□566□-□	AH16K-□569□-□
Max. stop torque	4.2 kgf cm (0.42 N m)	8.3 kgf cm (0.83 N m)	16.6 kgf cm (1.66 N m)
Rotor inertia moment	$175 \times 10^{-7} \text{ kg} \cdot \text{m}^2$	$280 \times 10^{-7} \text{ kg} \cdot \text{m}^2$	$560 \times 10^{-7} \text{ kg} \cdot \text{m}^2$
Rated current	S: 0.75 A / Phase M: 1.4 A / Phase		
Basic step angle	0.72° / 0.36° (Full / Half step)		
Unit weight (packaged)	≈ 0.60 kg (≈ 0.87 kg)	≈ 0.80 kg (≈ 1.07 kg)	≈ 1.30 kg (≈ 1.57 kg)
Model	AH21K-□596□-□	AH41K-□599□-□	AH63K-□5913□-□
Max. stop torque	21 kgf cm (2.1 N m)	41 kgf cm (4.1 N m)	63 kgf cm (6.3 N m)
Rotor inertia moment	$1,400 \times 10^{-7} \text{ kg} \cdot \text{m}^2$	$2,700 \times 10^{-7} \text{ kg} \cdot \text{m}^2$	$4,000 \times 10^{-7} \text{ kg} \cdot \text{m}^2$
Rated current	M: 1.4 A / Phase G: 2.8 A / Phase		
Basic step angle	0.72° / 0.36° (Full / Half step)		
Unit weight (packaged)	≈ 1.70 kg (≈ 2.18 kg)	≈ 2.80 kg (≈ 3.28 kg)	≈ 3.80 kg (≈ 4.28 kg)
Motor phase	5-phase		
Insulation class	B type (130°C)		
Insulation resistance	Between motor coil and case: $\geq 100 \text{ M}\Omega$ (500 VDC≡ megger)		
Dielectric strength ⁰¹⁾	Between motor coil and case: 1,000 VAC~ 50 / 60 Hz for 1 minute		
Temperature rise	$\leq 80^\circ\text{C}$ (5-phase excitation for rated current, while stop)		
Ambient temp.	-10 to 50°C, storage: -25 to 85°C (no freezing or condensation)		
Ambient humi.	35 to 85%RH, storage: 35 to 85%RH (no freezing or condensation)		
Protection rating	IP30 (IEC34-5 standard)		
Approval	CE [RE]		

01) In case of rated current: 0.75 A / Phase, Between motor coil and case: 500 VAC~ 50 / 60 Hz for 1 minute

Built-In Gear / Rotary Actuator Type 5-Phase Stepper Motors

(□ 42 / 60 / 85 mm)

AK-G / AK-R Series



Features

- Ideal for building compact sized system
- Low price for improved cost efficiency
- Backlash □ 42 mm: ± 35' (0.58°),
□ 60 mm: ± 20' (0.33°), □ 85 mm: ± 15' (0.25°)
- Brake releases when 24 VDC is applied on
brake wire (AK-GB Series, AK-RB Series)
- Basic step angle 1:5 → 0.144°, 1:7.2 → 0.1°,
1:10 → 0.072°
- Allowable speed 1:5 → 0 to 360 rpm,
1:7.2 → 0 to 250 rpm, 1:10 → 0 to 180 rpm

Specifications

Model	A10K-S545□-□5	A15K-S545□-□7.2	A15K-S545□-□10
Max. allowable torque	10 kgf cm (1.0 N m)	15 kgf cm (1.5 N m)	
Rotor inertia moment ⁰¹⁾	68×10 ⁻⁷ kg · m ²		
Rated current	0.75 A / Phase		
Basic step angle	0.144° / 0.072° (Full / Half step)	0.1° / 0.05° (Full / Half step)	0.072° / 0.036° (Full / Half step)
Allowable speed range	0 to 360 rpm	0 to 250 rpm	0 to 180 rpm
Backlash	± 35' (0.58°)		
Unit weight (packaged) ⁰²⁾	≈ 0.58 kg (≈ 0.68 kg) ≈ 0.72 kg (≈ 0.78 kg)		

Model	A35K-M566□-□5	A40K-M566□-□7.2	A50K-M566□-□10
Max. allowable torque	35 kgf cm (3.5 N m)	40 kgf cm (4.0 N m)	50 kgf cm (5.0 N m)
Rotor inertia moment ⁰¹⁾	280×10 ⁻⁷ kg · m ²		
Rated current	1.4 A / Phase		
Basic step angle	0.144° / 0.072° (Full / Half step)	0.1° / 0.05° (Full / Half step)	0.072° / 0.036° (Full / Half step)
Allowable speed range	0 to 360 rpm	0 to 250 rpm	0 to 180 rpm
Backlash	± 20' (0.33°)		
Unit weight (packaged) ⁰²⁾	Built-in gear type: ≈ 1.30 kg (≈ 1.57 kg) Built-in rotary actuator type: ≈ 1.30 kg (≈ 1.40 kg) Built-in gear type: ≈ 0.95 kg (≈ 1.03 kg) Built-in rotary actuator type: ≈ 1.60 kg (≈ 1.70 kg)		

Model	A140K-□599□-□5	A200K-□599□-□7.2	A200K-□599□-□10
Max. allowable torque	140 kgf cm (14.0 N m)	200 kgf cm (20.0 N m)	
Rotor inertia moment ⁰¹⁾	2,700×10 ⁻⁷ kg · m ²		
Rated current	M: 1.4 A / Phase G: 2.8 A / Phase		
Basic step angle	0.144° / 0.072° (Full / Half step)	0.1° / 0.05° (Full / Half step)	0.072° / 0.036° (Full / Half step)
Allowable speed range	0 to 360 rpm	0 to 250 rpm	0 to 180 rpm
Backlash	± 15' (0.25°)		
Unit weight (packaged) ⁰¹⁾	≈ 4.40 kg (≈ 4.88 kg) ≈ 2.64 kg (≈ 2.74 kg)		

01) Listed in order of Standard type
Built-in brake type

Next Page ►

Motor phase	5-phase
Insulation class	B type (130°C)
Insulation resistance	Between motor coil and case: $\geq 100 \text{ M}\Omega$ (500 VDC= megger)
Dielectric strength ⁰¹⁾	Between motor coil and case: 1,000 VAC~ 50 / 60 Hz for 1 minute
Temperature rise ⁰²⁾	$\leq 80^\circ\text{C}$ (5-phase excitation for rated current, while stop)
Ambient temp.	-10 to 50°C, storage: -25 to 85°C (no freezing or condensation)
Ambient humi.	35 to 85%RH, storage: 35 to 85%RH (no freezing or condensation)
Protection rating	IP30 (IEC34-5 standard)
Approval	CE EAC
Stop angle error ⁰²⁾	$\pm 3'$ ($\pm 0.05^\circ$) (Full step, no load)
Absolut position error ⁰³⁾	$\pm 20'$ ($\pm 0.33^\circ$)
Lost motion ⁰³⁾	$\pm 20'$ ($\pm 0.33^\circ$)
Shaft vibration	0.05 mm T.I.R.
Radial movement ⁰⁴⁾	$\leq 0.025 \text{ mm}$ T.I.R.
Axial movement ⁰⁵⁾	$\leq 0.075 \text{ mm}$ T.I.R.
Shaft concentricity	0.075 mm T.I.R.
Shaft perpendicularity	0.075 mm T.I.R.

01) In case of rated current: 0.75 A / Phase, Between motor coil and case: 500 VAC~ 50 / 60 Hz for 1 minute

02) The corresponding value is only available in built-in gear type.

03) The corresponding value is only available in built-in rotary actuator type.

04) Amount of radial shaft displacement when applying radial load (5 N) to the end of the shaft.

05) Amount of axial shaft displacement when applying axial load (10 N) to the shaft.

Built-in brake type Frame size	<input type="checkbox"/> 42 mm	<input type="checkbox"/> 60 mm	<input type="checkbox"/> 85 mm
Rated excitation voltage	24 VDC= $\pm 10\%$		
Rated excitation current	0.2 A	0.33 A	0.62 A
Static friction torque	$\geq 0.18 \text{ N}\cdot\text{m}$	$\geq 0.8 \text{ N}\cdot\text{m}$	$\geq 4.0 \text{ N}\cdot\text{m}$
Rotation part inertia moment	$3 \times 10^{-7} \text{ kg}\cdot\text{m}^2$	$29 \times 10^{-7} \text{ kg}\cdot\text{m}^2$	$153 \times 10^{-7} \text{ kg}\cdot\text{m}^2$
Insulation class	B type (130°C)		
B type brake	Brake is released when power ON, brake is locked when power OFF		
Operating time	$\leq 25 \text{ ms}$	$\leq 25 \text{ ms}$	$\leq 60 \text{ ms}$
Releasing time	$\leq 15 \text{ ms}$	$\leq 20 \text{ ms}$	$\leq 15 \text{ ms}$

Micro Step 5-Phase Stepper Motor Drivers

MD5-HD14 Series



Features

- Bipolar constant current pentagon drive method
- Various built-in functions including auto current down and self-diagnosis
- Low speed rotation and extreme precision control with micro stepping drive (Max. resolution is 250 divisions. In case of 5 phase stepper motor with 0.72° basic step angle, it can be controlled down to 0.00288° per pulse, 125000 pulses are required for a single revolution.)
- Isolated photocoupler input design minimizes influence from electrical noise

Specifications

Model	MD5-HD14
Power supply ⁰¹⁾	24 - 35 VDC \pm \pm 10%
Max. current consumption	3 A (based on ambient temp. 25°C, ambient humi. 55%RH)
RUN current ⁰²⁾	0.4 - 1.4 A / Phase
Stop current	27 to 90% of RUN current (set by STOP current setting rotary switch)
RUN method	Bipolar constant current pentagon drive
Basic step angle	0.72° / Step
Resolution	1, 2, 4, 5, 8, 10, 16, 20, 25, 40, 50, 80, 100, 125, 200, 250 division (0.72° to 0.00288° / Step)
Pulse width	\geq 10 μ s (CW / CCW), \geq 1 ms (HOLD OFF)
Duty rate	50% (CW / CCW)
Rise, Fall time	\leq 130 ns (CW / CCW)
Pulse input voltage	[H]: 4 - 8 VDC \pm , [L]: 0 - 0.5 VDC \pm
Pulse input current	7.5 - 14 mA (CW / CCW), 10 - 16 mA (HOLD OFF, DIVISION SELECTION, ZERO OUT)
Max. input pulse freq.	\leq 500 kHz (CW / CCW)
Input resistance	270 Ω (CW / CCW), 390 Ω (HOLD OFF, DIVISION SELECTION), 10 Ω (ZERO OUT)
Insulation resistance	Between all terminal and case: \geq 100 M Ω (500 VDC \pm megger)
Dielectric strength	Between all terminal and case: 1,000 VAC \sim 50 / 60 Hz for 1 minute
Noise immunity	\pm 500 VDC \pm square wave noise (pulse width: 1 μ s) by the noise simulator
Vibration	1.5 mm double amplitude at frequency 5 to 60 Hz (for 1 minute) in each X, Y, Z direction for 2 hours
Vibration (malfunction)	1.5 mm double amplitude at frequency 5 to 60 Hz (for 1 minute) in each X, Y, Z direction for 10 minutes
Ambient temp.	0 to 40°C, storage: -10 to 60°C (no freezing or condensation)
Ambient humi.	35 to 85% RH, storage: 35 to 85% RH (no freezing or condensation)
Approval	CE ENEC
Unit weight (packaged)	\approx 220 g (\approx 327.5 g)

01) If a power supply is over 30 VDC \pm , the torque characteristics in the high speed range will improve, but the driver's temperature will increase as well. Install the unit in well-ventilated area. The torque may vary depending on power supply.

02) RUN current varies depending on the RUN frequency, and the max. instantaneous RUN current varies depending on load.

Micro Step

5-Phase Stepper

Motor Drivers

MD5-HF14 Series



Features

- Bipolar constant current pentagon drive method
- Various built-in functions including auto current down and self-diagnosis
- Low speed rotation and extreme precision control with micro stepping drive (Max. resolution is 250 divisions. In case of 5 phase stepper motor with 0.72° basic step angle, it can be controlled down to 0.00288° per pulse, 125000 pulses are required for a single revolution.)
- Isolated photocoupler input design minimizes influence from electrical noise

Specifications

Model	MD5-HF14
Power supply	100 - 220 VAC~ 50 / 60 Hz ± 10%
Max. current consumption	3 A (based on ambient temp. 25°C, ambient humi. 55%RH)
RUN current ⁰¹⁾	0.4 - 1.4 A / Phase
Stop current	27 to 90% of RUN current (set by STOP current setting rotary switch)
RUN method	Bipolar constant current pentagon drive
Basic step angle	0.72° / Step
Resolution	1, 2, 4, 5, 8, 10, 16, 20, 25, 40, 50, 80, 100, 125, 200, 250 division (0.72° to 0.00288° / Step)
Pulse width	≥ 1 μs (CW / CCW), ≥ 1 ms (HOLD OFF)
Duty rate	50% (CW / CCW)
Rise, Fall time	≤ 130 ns (CW / CCW)
Pulse input voltage	[H]: 4 - 8 VDC≡, [L]: 0 - 0.5 VDC≡
Pulse input current	7.5 - 14 mA (CW / CCW), 10 - 16 mA (HOLD OFF, DIVISION SELECTION, ZERO OUT)
Max. input pulse freq.	≤ 500 kHz (CW / CCW)
Input resistance	270 Ω (CW / CCW), 390 Ω (HOLD OFF, DIVISION SELECTION), 10 Ω (ZERO OUT)
Insulation resistance	Between all terminal and case: ≥ 100 MΩ (500 VDC≡ megger)
Dielectric strength	Between all terminal and case: 1,000 VAC~ 50 / 60 Hz for 1 minute
Noise immunity	± 2000 VDC≡ square wave noise (pulse width: 1 μs) by the noise simulator
Vibration	1.5 mm double amplitude at frequency 5 to 60 Hz (for 1 minute) in each X, Y, Z direction for 2 hours
Vibration (malfunction)	1.5 mm double amplitude at frequency 5 to 60 Hz (for 1 minute) in each X, Y, Z direction for 10 minutes
Ambient temp.	0 to 50°C, storage: -10 to 60°C (no freezing or condensation)
Ambient humi.	35 to 85% RH, storage: 35 to 85% RH (no freezing or condensation)
Approval	CE  ENEC
Unit weight (packaged)	≈ 690 g (≈ 840 g)

01) RUN current varies depending on the RUN frequency, and the max. instantaneous RUN current varies depending on load.

Micro Step 5-Phase Stepper Motor Drivers

MD5-HF14-AO Series



Features

- Bipolar constant current pentagon drive method
- Various built-in functions including auto current down and self-diagnosis
- Low speed rotation and extreme precision control with micro stepping drive (Max. resolution is 250 divisions. In case of 5 phase stepper motor with 0.72° basic step angle, it can be controlled down to 0.00288° per pulse, 125000 pulses are required for a single revolution.)
- Isolated photocoupler input design minimizes influence from electrical noise

Specifications

Model	MD5-HF14-AO
Power supply	100 - 220 VAC~ 50 / 60 Hz ± 10%
Max. current consumption	3 A (based on ambient temp. 25°C, ambient humi. 55%RH)
RUN current ⁰¹⁾	0.4 - 1.4 A / Phase
Stop current	27 to 90% of RUN current (set by STOP current setting rotary switch)
RUN method	Bipolar constant current pentagon drive
Basic step angle	0.72° / Step
Resolution	1, 2, 4, 5, 8, 10, 16, 20, 25, 40, 50, 80, 100, 125, 200, 250 division (0.72° to 0.00288° / Step)
Pulse width	≥ 1 μs (CW / CCW), ≥ 1 ms (HOLD OFF)
Duty rate	50% (CW / CCW)
Rise, Fall time	≤ 130 ns (CW / CCW)
Pulse input voltage	[H]: 4 - 8 VDC≐, [L]: 0 - 0.5 VDC≐
Pulse input current	7.5 - 14 mA (CW / CCW), 10 - 16 mA (HOLD OFF)
Max. input pulse freq.	≤ 500 kHz (CW / CCW)
Input resistance	270 Ω (CW / CCW), 390 Ω (HOLD OFF), 10 Ω (ALARM)
Insulation resistance	Between all terminal and case: ≥ 100 MΩ (500 VDC≐ megger)
Dielectric strength	Between all terminal and case: 1,000 VAC~ 50 / 60 Hz for 1 minute
Noise immunity	± 2000 VDC≐ square wave noise (pulse width: 1 μs) by the noise simulator
Vibration	1.5 mm double amplitude at frequency 5 to 60 Hz (for 1 minute) in each X, Y, Z direction for 2 hours
Vibration (malfunction)	1.5 mm double amplitude at frequency 5 to 60 Hz (for 1 minute) in each X, Y, Z direction for 10 minutes
Ambient temp.	0 to 50°C, storage: -10 to 60°C (no freezing or condensation)
Ambient humi.	35 to 85% RH, storage: 35 to 85% RH (no freezing or condensation)
Approval	CE, RoHS, EAC
Unit weight (packaged)	≈ 660 g (≈ 820 g)

01) RUN current varies depending on the RUN frequency, and the max. instantaneous RUN current varies depending on load.

Micro Step

5-Phase Stepper

Motor Drivers

MD5-HF28 Series

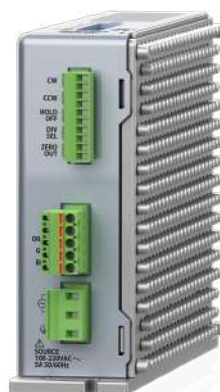

Features

- Bipolar constant current pentagon drive method
- Various built-in functions including auto current down and self-diagnosis
- Low speed rotation and extreme precision control with micro stepping drive (Max. resolution is 250 divisions. In case of 5 phase stepper motor with 0.72° basic step angle, it can be controlled down to 0.00288° per pulse, 125000 pulses are required for a single revolution.)
- Isolated photocoupler input design minimizes influence from electrical noise

Specifications

Model	MD5-HF28
Power supply	100 - 220 VAC~ 50 / 60 Hz ± 10%
Max. current consumption	5 A (based on ambient temp. 25°C, ambient humi. 55%RH)
RUN current ⁰¹⁾	1.0 - 2.8 A / Phase
Stop current	27 to 90% of RUN current (set by STOP current setting rotary switch)
RUN method	Bipolar constant current pentagon drive
Basic step angle	0.72° / Step
Resolution	1, 2, 4, 5, 8, 10, 16, 20, 25, 40, 50, 80, 100, 125, 200, 250 division (0.72° to 0.00288° / Step)
Pulse width	≥ 1 μs (CW / CCW), ≥ 1 ms (HOLD OFF)
Duty rate	50% (CW / CCW)
Rise, Fall time	≤ 130 ns (CW / CCW)
Pulse input voltage	[H]: 4 - 8 VDC≡, [L]: 0 - 0.5 VDC≡
Pulse input current	7.5 - 14 mA (CW / CCW), 10 - 16 mA (HOLD OFF, DIVISION SELECTION, ZERO OUT)
Max. input pulse freq.	≤ 500 kHz (CW / CCW)
Input resistance	270 Ω (CW / CCW), 390 Ω (HOLD OFF, DIVISION SELECTION), 10 Ω (ZERO OUT)
Insulation resistance	Between all terminal and case: ≥ 100 MΩ (500 VDC≡ megger)
Dielectric strength	Between all terminal and case: 1,000 VAC~ 50 / 60 Hz for 1 minute
Noise immunity	± 2000 VDC≡ square wave noise (pulse width: 1 μs) by the noise simulator
Vibration	1.5 mm double amplitude at frequency 5 to 60 Hz (for 1 minute) in each X, Y, Z direction for 2 hours
Vibration (malfunction)	1.5 mm double amplitude at frequency 5 to 60 Hz (for 1 minute) in each X, Y, Z direction for 10 minutes
Ambient temp.	0 to 50°C, storage: -10 to 60°C (no freezing or condensation)
Ambient humi.	35 to 85% RH, storage: 35 to 85% RH (no freezing or condensation)
Approval	CE  ENEC
Unit weight (packaged)	≈ 1.2 kg (≈ 1.35 kg)

01) RUN current varies depending on the RUN frequency, and the max. instantaneous RUN current varies depending on load.

Micro Step

5-Phase Stepper

Motor Drivers

MD5-ND14 Series

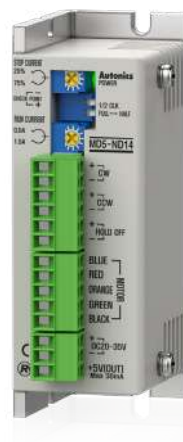

Features

- Bipolar constant current pentagon drive method
- Various built-in functions including auto current down and self-diagnosis
- Isolated photocoupler input design minimizes influence from electrical noise

Specifications

Model	MD5-ND14
Power supply ⁰¹⁾	20 - 35 VDC \pm 10%
Max. current consumption	3 A (based on ambient temp. 25°C, ambient humi. 55%RH)
RUN current ⁰²⁾	0.5 - 1.5 A / Phase
Stop current	25 to 75% of RUN current (set by STOP current setting rotary switch)
RUN method	Bipolar constant current pentagon drive
Basic step angle	0.72° / Step
Resolution	1 division (0.72° / Step), 2 division (0.36° / Step)
Pulse width	\geq 10 μ s (CW / CCW), 1 ms (HOLD OFF)
Duty rate	50% (CW / CCW)
Rise, Fall time	\leq 130 ns (CW / CCW)
Pulse input voltage	[H]: 4 - 8 VDC \pm , [L]: 0 - 0.5 VDC \pm
Pulse input current	7.5 - 14 mA (CW / CCW), 10 - 16 mA (HOLD OFF)
Max. input pulse freq.	\leq 50 kHz (CW / CCW)
Input resistance	390 Ω (CW/CCW, HOLD OFF)
Insulation resistance	Between all terminal and case: \geq 100 M Ω (500 VDC \pm megger)
Dielectric strength	Between all terminal and case: 1,000 VAC \sim 50 / 60 Hz for 1 minute
Noise immunity	\pm 500 VDC \pm square wave noise (pulse width: 1 μ s) by the noise simulator
Vibration	1.5 mm double amplitude at frequency 5 to 60 Hz (for 1 minute) in each X, Y, Z direction for 2 hours
Vibration (malfunction)	1.5 mm double amplitude at frequency 5 to 60 Hz (for 1 minute) in each X, Y, Z direction for 10 minutes
Ambient temp.	0 to 40°C, storage: -10 to 60°C (no freezing or condensation)
Ambient humi.	35 to 85% RH, storage: 35 to 85% RH (no freezing or condensation)
Approval	CE ENEC
Unit weight (packaged)	\approx 130 g (\approx 183 g)

01) If a power supply is over 30 VDC \pm , the torque characteristics in the high speed range will improve, but the driver's temperature will increase as well. Install the unit in well-ventilated area. The torque may vary depending on power supply.

02) RUN current varies depending on the RUN frequency, and the max. instantaneous RUN current varies depending on load.

Micro Step

5-Phase Stepper Motor Drivers

MD5-HD14-2X / MD5-HD14-3X Series



Features

- Bipolar constant current pentagon drive method
- Various built-in functions including auto current down and self-diagnosis
- Isolated photocoupler input design minimizes influence from electrical noise

Specifications

Model	MD5-HD14-2X	MD5-HD14-3X
Number of axes	2-axis	3-axis
Power supply ⁰¹⁾	20 - 35 VDC \pm 10%	
Max. current consumption ⁰²⁾	5 A	7 A
RUN current ⁰³⁾	0.4 - 1.4 A / Phase	
Stop current	27 to 90% of RUN current (set by STOP current setting rotary switch)	
RUN method	Bipolar constant current pentagon drive	
Basic step angle	0.72° / Step	
Resolution	1, 2, 4, 5, 8, 10, 16, 20, 25, 40, 50, 80, 100, 125, 200, 250 division (0.72° to 0.00288° / Step)	
Pulse width	$\geq 1 \mu\text{s}$ (CW / CCW), $\geq 1 \text{ms}$ (HOLD OFF)	
Duty rate	50% (CW / CCW)	
Rise, Fall time	$\leq 130 \text{ns}$ (CW / CCW)	
Pulse input voltage	[H]: 4 - 8 VDC \pm , [L]: 0 - 0.5 VDC \pm	
Pulse input current	7.5 - 14 mA (CW / CCW), 10 - 16 mA (HOLD OFF, ZERO OUT)	
Max. input pulse freq.	$\leq 500 \text{kHz}$ (CW / CCW)	
Input resistance	270 Ω (CW / CCW), 390 Ω (HOLD OFF), 10 Ω (ZERO OUT)	
Insulation resistance	Between all terminal and case: $\geq 100 \text{M}\Omega$ (500 VDC \pm megger)	
Dielectric strength	Between all terminal and case: 1,000 VAC \sim 50 / 60 Hz for 1 minute	
Noise immunity	$\pm 500 \text{VDC}\pm$ square wave noise (pulse width: 1 μs) by the noise simulator	
Vibration	1.5 mm double amplitude at frequency 5 to 60 Hz (for 1 minute) in each X, Y, Z direction for 2 hours	
Vibration (malfunction)	1.5 mm double amplitude at frequency 5 to 60 Hz (for 1 minute) in each X, Y, Z direction for 10 minutes	
Ambient temp.	0 to 40°C, storage: -10 to 60°C (no freezing or condensation)	
Ambient humi.	35 to 85% RH, storage: 35 to 85% RH (no freezing or condensation)	
Approval	CE EAC	
Unit weight (packaged)	$\approx 292 \text{g}$ ($\approx 446 \text{g}$)	$\approx 411 \text{g}$ ($\approx 597 \text{g}$)

01) If a power supply is over 30 VDC \pm , the torque characteristics in the high speed range will improve, but the driver's temperature will increase as well. Install the unit in well-ventilated area. The torque may vary depending on power supply.

02) Based on ambient temp. 25°C, ambient humi. 55%RH

03) RUN current varies depending on the RUN frequency, and the max. instantaneous RUN current varies depending on load.



G4. Motion Controllers

Motion controllers are devices that generate pulse signals for precise and proper control of stepper motor drivers and stepper motors.

G4-1	Stand-Alone	PMC-1HS / PMC-2HS Series	1 Axis / 2 Axis Motion Controllers
		PMC-2HSP Series	2 Axis Interpolation Type Motion Controllers
G4-2	PCI Card	PMC-4B-PCI Series	4 Axis Board Type Motion Controllers

1 Axis / 2 Axis Motion Controllers

PMC-1HS / PMC-2HS Series



Features

- High-speed processing up to 4 Mpps
- 4 operation modes: Scan mode, Continuous mode, Index mode, Program mode
- 12 control commands and up to 64 steps of programming per axis
- Parallel interface input/output terminal to communicate with various PLCs
- Operation programming, parameter configuration and editing with dedicated software
- Joystick signal support for convenient XY stage control
- Remote controlling possible with serial port (RS232C) on all models
- Teaching and monitoring with Teaching Unit (PMC-2TU-232)

Specifications

Model	PMC-1HS-232	PMC-1HS-USB	PMC-2HS-232	PMC-2HS-USB
Power supply	24 VDC \pm 10%			
Power consumption	\leq 6 W			
Control axes	1 axis		2 axis (each axis can be programmed independently)	
Motor control	Pulse input stepper motor or servo motor			
In-Position setting	ABSOLUTE method / INCREMENTAL method			
In-Position range	-8,388,608 to +8,388,607 (available pulse scaling function)			
Drive speed	1 pps to 4 Mpps (1 to 8000 \times magnification 1 to 500)			
Pulse output method	2 pulse output method (line driver output)			
Operation mode	Jog mode, Continuous mode, Index mode, Program mode			
No. of drive speed	4			
Program save	EEPROM			
Index steps	64 step per each axis			
Steps	64 Step			
Control command	ABS, INC, HOM, IJP, OUT, OTP, JMP, REP, RPE, END, TIM, NOP			
Program function	Power On Program Start, Power On Home Search			
Home search mode	High speed near home search (STEP1) \rightarrow Low speed near home search (STEP2) \rightarrow Encoder Z phase search (STEP3) \rightarrow Offset movement (STEP4) Configuring the detection direction and Enable/Disable in each step			
General output	1 point		2 point	
Control interface	Parallel I/F			
Ambient temp.	0 to 45°C (no freezing or condensation)			
Ambient humi.	35 to 85%RH (no freezing or condensation)			
Approval	CE EAC			
Unit weight (packaged)	\approx 96.8 g (\approx 386 g)	\approx 96.9 g (\approx 421.6 g)	\approx 100.2 g (\approx 393.6 g)	\approx 100.4 g (\approx 432.2 g)

2 Axis Interpolation Type Motion Controllers

PMC-2HSP Series



Features

- High speed independent 2 axis control with processing speed up to 4 Mpps
- Supports linear and circular interpolation control
- 17 control commands and up to 200 steps of operation programming
- Supports various control interfaces (USB, RS232C, RS485, Parallel I/F)
- Multiple control of up to 32 axes (16 units) with RS485 communication (Modbus RTU)
- 4 operation modes: Jog mode, Continuous mode, Index mode, Program mode
- Symmetrical / asymmetrical trapezoid or S-shaped acceleration/deceleration control

Specifications

Model	PMC-2HSP-USB	PMC-2HSP-485
Power supply	24 VDC \pm 10%	
Power consumption	\leq 6 W	
Control output	50 mA	
Control axes	2 axis	
Motor control	Pulse input stepper motor or servo motor	
In-Position range	-8,388,608 to +8,388,607 (selectable absolute / relative value, available pulse scaling function)	
Drive speed	1 pps to 4 Mpps (1 to 8,000 pps \times magnification 1 to 500)	
Pulse output method	1 pulse / 2 pulse output method (line driver output)	
Operation mode	Jog mode, Continuous mode, Index mode, Program mode	
Index steps	64 step for each axis	
Steps	200 steps	
Control command	ABS, INC, HOM, LID, CID, FID, RID, FRID, TIM, JMP, REP, RPE, ICJ, IRD, OPC, OPT, NOP, END	
Program function	Power On Program Start, Power On Home Search	
Home search mode	High speed near home search (STEP1) \rightarrow Low speed near home search (STEP2) \rightarrow Encoder Z phase search (STEP3) \rightarrow Offset movement (STEP4)	
I/O	Parallel I/F (CN3): 13 inputs, 4 outputs X axis (CN4): 8 inputs, 6 outputs (2 general input, 2 general output) Y axis (CN5): 8 inputs, 6 outputs (2 general input, 2 general output)	
Ambient temp.	0 to 45°C, storage: -15 to 70°C (no freezing or condensation)	
Ambient humi.	20 to 90%RH, storage: 20 to 90%RH (no freezing or condensation)	
Approval	CE ENEC	CE ENEC
Unit weight (packaged)	\approx 101.5 g (\approx 344 g)	\approx 101.6 g (\approx 308.7 g)

4 Axis Board Type Motion Controllers

PMC-4B-PCI Series



Features

- Independent 4-axis control of AC servo motors and stepper motors
- PC-PCI card type
- Auto home search function and synchronous operation
- Interpolation control for circular, linear, bit pattern, continuous, acceleration, and deceleration drives
- 2-axis / 3-axis constant linear velocity
- Supports Windows 98, NT, 2000, XP, Windows 7
- Labview library and help, and C language library and samples available on www.autonics.com

Specifications

Model	PMC-4B-PCI
Power supply	5 VDC \pm 10% (using PC internal power)
External power supply	12 - 24 VDC \pm 10%
Control axes	4 axis
CPU data bus	8 / 16 bit selection
Ambient temp.	0 to 45°C, storage: -10 to 55°C (no freezing or condensation)
Ambient humi.	35 to 85%RH, storage: 35 to 85%RH (no freezing or condensation)
Approval	CE EMI
Unit weight (packaged)	\approx 100.4 g (\approx 654.4 g)
2/3 axis linear interpolation range	-2,147,483,648 to +2,147,483,647 for each axis
2/3 axis linear interpolation speed	1 pps to 4 Mpps
2/3 axis linear interpolation position accuracy	\leq \pm 0.5 LBS (within all interpolation range)
2/3 axis bit pattern interpolation speed	1 pps to 4 Mpps (depending on CPU data setup time)
Circular interpolation range	-2,147,483,648 to +2,147,483,647 for each axis
Circular interpolation speed	1 pps to 4 Mpps
Circular interpolation position accuracy	\leq \pm 1 LBS (within all interpolation range)
Other interpolation function	Select specific axis, constant linear velocity, continuous interpolation step transmission (command, external signal)
Encoder input pulse	2-phase pulse / up down pulse input, 2-phase pulse 1 / 2 / 4-multiply selection
Logic pos. counter range	-2,147,483,648 to +2,147,483,647 (for output pulse)
Actual pos. counter range	-2,147,483,648 to +2,147,483,647 (for input pulse)
Compare register	Comp. \pm register pos. comparison range: -2,147,483,648 to +2,147,483,647 Output and signal output when the current counter value and the user position counter are same Software limit operation
Auto home search	High speed near home search (step1) \rightarrow Low speed near home search (step2)
Interrupt function (except interpolation)	1 drive pulse output: when changing position counter \geq Comp. -, when changing position counter \geq Comp. +, when changing position counter $<$ Comp. -, when changing position counter $<$ Comp. +, when starting constant speed in accel/decel drive, when ending constant speed in accel/decel drive, when ending drive auto home search, when ending auto home search, when running synchronous operation
Drive control by external signal	\pm direction fixed/continuous pulse drive by EXP+, EXP- signal 2-phase encoder signal mode (encoder input) drive
External deceleration stop / immediate stop signal	IN 0 to 3 each axis 4 point Select signal valid/invalid and logic level selection, use general input
Servo motor input signal	Select alarm, INPOS signal valid/invalid and logic level
General output signal	OUT4 to 7 each axis 4 point (both drive status output signal and terminal)
Drive status signal output	ASND (while acceleration), DSND (while deceleration)
Overrun limit signal input	Select +direction, -direction each 1 point and logic level Select stop/deceleration stop at active
Emergency stop signal input	EMG 1 point, stop drive pulse for all axes by low level
Integral filter	Built-in integral filter at each input signal input terminal, pass time (8 type) selection
Others	Select specific axis, constant linear velocity, continuous interpolation, interpolation step transmission (command, external signal)

H. Industrial Networking

Industrial networking devices allow communication between devices using various protocols such as Ethernet, offering safe transmission of real-time data to control systems.

H1. Network Converters

H2. Remote I/O System

H3. Signal Conditioners







H1. Network Converters

Network Converters allow networking between devices with communication capability.

H1-1	Wireless Communication	SCM-WF48 Series	Wireless Serial Communication Converters
H1-2	Communication	SCM Series	Serial Communication Converters

Wireless Serial Communication Converters

SCM-WF48 Series



Features

- Converting USB or RS485 signal to Wi-Fi signal, and wireless communication up to max. 100 m
- Compact size
(W 48 × H 25.6 × L 76.3 mm, except antenna)
- Built-in surge protection circuit, reverse polarity protection circuit
- Supports AP mode and station mode
- Various mounting methods (DIN rail, panel)

Specifications

Model	SCM-WF48
Power supply	24 VDC \equiv
Allowable voltage range	12 - 28 VDC \equiv
Power consumption	\approx 3 W
Communication type	RS485, USB, WiFi
Isolation resistance	\geq 200 M Ω (at 500 VDC \equiv megger between external terminal and case)
Protection circuit	Reverse polarity protection circuit, surge protection circuit
Dielectric strength	1,000 VAC \sim 50/60 Hz for 1 min (between external terminal and case)
Noise immunity	\pm 500 VDC \equiv the square wave noise (pulse width: 1 μ s) by the noise simulator
Vibration	1.5 mm amplitude at frequency of 10 to 55 Hz (for 1 min) in each X, Y, Z direction for 2 hours
Shock	500 m/s 2 (\approx 50 G) in each X, Y, Z direction for 3 times
Ambient temperature	-10 to 55 $^{\circ}$ C, storage: -20 to 60 $^{\circ}$ C (no freezing or condensation)
Ambient humidity	35 to 80 %RH, storage: 35 to 80 %RH (no freezing or condensation)
Protection rating	IP20 (IEC standards)
Installation method	DIN rail or panel mounting
Accessory	USB 2.0 Mini B type cable (length: 1 m): 1, Connector for RS485 (4-pin, male type): 1
Indicator	Indicates state of mode
Approval	CE ENEC
Unit weight (packaged)	\approx 57 g (\approx 160 g)

Communication Interface

[WiFi]

Comm. protocol	TCP/IP (IPv4)
Application standard	802.11b/g/n (IEEE 802.11b) compatible
Comm. distance	\leq 100 m
Comm. speed	\leq 11 Mbps
Frequency range	2.4 to 2.497 GHz
Security	WEP, WPA, WPA2-PSK, Enterprise
Antenna	2dBi external antenna

[RS485]

Application standard	EIA RS485
Max. connection	\leq 31-unit
Comm. synchronous method	Asynchronous
Comm. method	2-wire half duplex
Comm. distance	\leq 800 m
Comm. speed ⁰¹⁾	4,800 / 9,600 (default) / 19,200 / 38,400 / 57,600 / 115,200 bps
Data bit	5 bit, 6 bit, 7 bit, 8 bit (default)
Parity bit	None (default), Even, Odd
Stop bit	1 bit (default), 2 bit
Connection type	4-wire screw terminal (2-wire communication method)

01) You can set via DAQMaster.

[USB]

Power	5 VDC \pm , 500 mA
Application standard	USB 2.0 (compatible sub-transmission)
Comm. method	2-wire half duplex
Comm. distance	$\leq 1\text{ m} \pm 30\%$
Connection type	USB 2.0 Mini B type (male)

Serial Communication Converters

SCM Series



Features

[SCM-US / SCM-USP / SCM-SFL: USB ↔ Serial]

- Both USB 1.1 and USB 2.0 HOST controller compatible
- Data transmission / power supply indicating LED
- Easy to connect with PC
- Built-in protection circuit
- Ferrite core cable for noise reduction
- Non-isolation type

[SCM-38I: RS232C ↔ RS485]

- Built-in surge protection circuit
- The insulation type of signal line (insulating RS232C and RS485)
- Create Tx-Enable signal automatically

[SCM-US48I: USB ↔ RS485]

- Available to transmit signals to max. 1.2 km by converting USB signal to RS485 signal
- Realizing electrical insulation (2500 VRMS) between USB port and RS485 port through RS485 transceiver
- Improved stability and durability with built-in surge protection circuit
- Easy connections between devices with bus power supplied from USB host controller without external power supply
- Offering USB 2.0 A / B type cable with built-in ferrite core for noise reduction
- User friendly features through compatibility with USB 1.1 and USB 2.0

Specifications

There might be some differences depending on PC environment.
(Supported OS: Microsoft Windows)

Model	SCM-US	SCM-USP / SCM-SFL
Power supply	5 VDC≡ USB bus power ⁰¹⁾	
Power consumption	≈ 1 W	
Max. com. speed ⁰²⁾	1,200 to 115,200 bps (recommended: 9,600 bps)	
Communication type	Half duplex type	
Available com. distance	1.5 m (not extension)	
Connection type	USB: USB 2.0 A type (male)	Earphone jack (4 pole stereo phone plug) 4-pin connector for communication
Isolation type	Non-isolation	
Indicator	A.C.C (green), O.P.R (red)	
Approval	CE ENEC	CE E
Unit weight (packaged)	≈ 41 g (≈ 80 g)	

Model	SCM-38I	SCM-US48I
Power supply	12 - 24 VDC≡ ±10 %	5 VDC≡ USB bus power ⁰¹⁾
Power consumption	≈ 1.7 W	≈ 1 W
Max. com. speed ⁰²⁾	1,200 to 115,200 bps (recommended: 9,600 bps)	
Communication type	Half duplex type	
Available com. distance	≤ 1.2 km	USB: ≤ 1 m ± 30 %, RS485: ≤ 1.2 km
Multi-drop	≤ 31 Multi-drop	
Protocol ⁰²⁾	Data bit: 5bit, 6bit, 7bit, 8bit / Stop bit: 1bit, 2bit / Parity bit: None, Odd, Even	
Connection type	RS232C: D-sub 9-pin RS485: 4-wire screw terminal (2-wire communication type)	USB: USB 2.0 B type (male)
Protection circuit	Surge protection circuit	
Isolation type	Isolation	
Dielectric strength	Between whole terminals and case: 2,000 VAC~ 50/60 Hz for 1 min Between RS232C and RS485: 2,500 VAC~ 50/60 Hz for 1 min	Between whole terminals and case: 2,500 VAC~ 50/60 Hz for 1 min Between RS232C and RS485: 2,500 VAC~ 50/60 Hz for 1 min
Isolation resistance	≥ 100 MΩ (500 VDC≡ megger)	
Noise immunity	±500 VDC≡ the square wave noise (pulse width: 1μs) by the noise simulator	
Indicator	RUN (red)	
Accessory	-	USB 2.0 AB type cable (length: 1 m, sold separately, model: USB AB CABLE)
Approval	CE ENEC	
Unit weight (packaged)	≈ 46 g (≈ 106 g)	≈ 34.5 g (≈ 197 g)

01) USB bus Power is supplied from PC or USB host controller.

02) They are set by Hyper terminal, DAQMaster, ParaSet, and Modbus Poll.

Vibration	0.75 mm double amplitude at frequency of 10 to 55 Hz (for 1 min) in each X, Y, Z direction for 1 hour
Vibration (malfunction)	0.5 mm double amplitude at frequency of 10 to 55 Hz (for 1 min) in each X, Y, Z direction for 10 min
Shock	300 m/s ² (≈ 30 G) in each X, Y, Z direction for 3 times
Shock (malfunction)	100 m/s ² (≈ 10 G) X, Y, Z in each X, Y, Z direction for 3 times
Ambient temperature	-10 to 55 °C, storage: -20 to 60 °C (no freezing or condensation)
Ambient humidity	35 to 85 %RH, storage: 35 to 85 %RH (no freezing or condensation)



H2. Remote I/O System

Remote I/O systems allow transmission of input and output signals between secondary devices and master devices such as PCs or PLCs through various open protocol networks.

H2-1	Remote I/O Box	ADIO Series	Remote I/O Boxes (EtherCAT)
			Remote I/O Boxes (EtherNet/IP)
			Remote I/O Boxes (PROFINET)
H2-2	Slim Remote I/O	ARIO Series	Slim Remote I/O
H2-3	Remote I/O	ARD-D Series	DeviceNet Remote I/O (Standard Terminal Block Type)
		ARD-D Series	DeviceNet Remote I/O (Sensor Connector Type)
		ARD-A Series	DeviceNet Remote I/O (Analog, Terminal Block Type)
		ARM Series	Modbus Remote I/O

Remote I/O Boxes (EtherCAT)

ADIO Series



Features

- The upper level communication protocol: EtherCAT
- The lower level communication protocol: IO-Link ver. 1.1 (port class: Class A)
- Housing material: Zinc Die casting
- Protection rating: IP67, IP69K
- The daisy chain allows the power supply using the connection technology in a standardized 7 / 8" connector
- The maximum output current of power supply: 2 A per port
- I/O port settings and status monitoring (cable short / disconnection, connection status, etc.)
- Supports digital input filter

Specifications

[Electrical / Mechanical specifications]

Mode	ADIO-EC
Supply voltage	18 - 30 VDC==
Rated voltage	24 VDC==
Current consumption	2.4 W (≤ 216 W)
Supplying current per port	≤ 2 A/Port
Sensor current (US)	≤ 9 A
Dimensions	W 66 × H 215 × D 38 mm
Material	Zinc Die casting
Ethernet port	M12 (Socket-Female), 4-pin, D-coded, Push-Pull Number of ports: 2 (IN/OUT) Supported function: daisy chain
Power supply port	Input: 7/8" (Plug-Male), 5-pin Output: 7/8" (Socket-Female), 5-pin Number of ports: 2 (IN/OUT) Supported function: daisy chain
PDCT port	M12 (Socket-Female), 5-pin, A-coded, Push-Pull Number of ports: 1 Connection method: USB serial communication
I/O port	M12 (Socket-Female), 5-pin, A-coded, Push-Pull Number of ports: 8
Mounting method	Mounting hole: fixed with M4 screw
Grounding method	Grounding hole: fixed with M4 screw
Unit weight (packaged)	≈ 700 g (≈ 900 g)
Comm. protocol	EtherCAT, IO-Link

[Mode specifications]

Mode	Digital Input
Number of channels	16-CH (I/Q: 8-CH, C/Q: 8-CH)
I/O common	NPN / PNP
Input current	5 mA
ON voltage/current	Voltage: ≥ 15 VDC== Current: ≥ 5 mA
OFF voltage	≤ 5 VDC==
Mode	Digital Output
Number of channels	8-CH (C/Q)
I/O common	NPN / PNP
Power supply	24 VDC== (18 - 30 VDC==), Max. 300 mA
Leakage current	≤ 0.1 mA
Residual voltage	≤ 1.5 VDC==
Short circuit protection	YES
Mode	IO-Link
Input current	2 mA
ON voltage / current	Voltage: ≥ 15 VDC== Current: ≥ 2 mA
OFF voltage	≤ 5 VDC==

[Environmental conditions]

Ambient temperature ⁰¹⁾	-5 to 70 °C, Storage: -25 to 70 °C (no freezing or condensation)
Ambient humidity	35 to 75%RH (no freezing or condensation)
Protection rating	IP67 (IEC standard), IP69K (DIN standard)

01) UL approved ambient temperature: 45 °C

[Approvals]

Approval	CE  
Association approval	 IO-Link 



Remote I/O Boxes (EtherNet/IP)

ADIO Series



Features

- The upper level communication protocol: EtherNet/IP
- The lower level communication protocol: IO-Link ver. 1.1 (port class: Class A)
- Housing material: Zinc Die casting
- Protection rating: IP67
- The daisy chain allows the power supply using the connection technology in a standardized 7 / 8" connector
- The maximum output current of power supply: 2 A per port
- I/O port settings and status monitoring (cable short / disconnection, connection status, etc.)
- Supports digital input filter

Specifications

[Electrical / Mechanical specifications]

Mode	ADIO-EI
Supply voltage	18 - 30 VDC \equiv
Rated voltage	24 VDC \equiv
Current consumption	2.4 W (\leq 216 W)
Supplying current per port	\leq 2 A/Port
Sensor current (US)	\leq 9 A
Dimensions	W 66 x H 215 x D 38 mm
Material	Zinc Die casting
Ethernet port	M12 (Socket-Female), 4-pin, D-coded, Push-Pull Number of ports: 2 (IN / OUT) Supported function: daisy chain
Power supply port	Input: 7/8" (Plug-Male), 5-pin Output: 7/8" (Socket-Female), 5-pin Number of ports: 2 (IN / OUT) Supported function: daisy chain
PDCT port	M12 (Socket-Female), 5-pin, A-coded, Push-Pull Number of ports: 1 Connection method: USB serial communication
I/O port	M12 (Socket-Female), 5-pin, A-coded, Push-Pull Number of ports: 8
Mounting method	Mounting hole: fixed with M4 screw
Grounding method	Grounding hole: fixed with M4 screw
Unit weight (packaged)	\approx 700 g (\approx 900 g)
Comm. protocol	EtherNet/IP, IO-Link

[Mode specifications]

Mode	Digital Input
Number of channels	16-CH (I/Q: 8-CH, C/Q: 8-CH)
I/O common	NPN / PNP
Input current	5 mA
ON voltage/current	Voltage: \geq 15 VDC \equiv Current: \geq 5 mA
OFF voltage	\leq 5 VDC \equiv
Mode	Digital Output
Number of channels	8-CH (C/Q)
I/O common	NPN / PNP
Power supply	24 VDC \equiv (18 - 30 VDC \equiv), Max. 300 mA
Leakage current	\leq 0.1 mA
Residual voltage	\leq 1.5 VDC \equiv
Short circuit protection	YES
Mode	IO-Link
Input current	2 mA
ON voltage / current	Voltage: \geq 15 VDC \equiv Current: \geq 2 mA
OFF voltage	\leq 5 VDC \equiv

[Environmental conditions]

Ambient temperature ⁰¹⁾	-5 to 70 °C, Storage: -25 to 70 °C (no freezing or condensation)
Ambient humidity	35 to 75%RH (no freezing or condensation)
Protection rating	IP67 (IEC standard)

01) UL approved ambient temperature: 45 °C

[Approvals]

Approval	CE  
Association approval	 IO-Link EtherNet/IP™



Remote I/O Boxes (PROFINET)

ADIO Series



Features

- The upper level communication protocol: PROFINET
- The lower level communication protocol: IO-Link ver. 1.1 (port class: Class A)
- Housing material: Zinc Die casting
- Protection rating: IP67
- The daisy chain allows the power supply using the connection technology in a standardized 7 / 8" connector
- The maximum output current of power supply: 2 A per port
- I/O port settings and status monitoring (cable short / disconnection, connection status, etc.)
- Supports digital input filter

Specifications

[Electrical / Mechanical specifications]

Mode	ADIO-PN
Supply voltage	18 - 30 VDC \equiv
Rated voltage	24 VDC \equiv
Current consumption	2.4 W (\leq 216 W)
Supplying current per port	\leq 2 A/Port
Sensor current (US)	\leq 9 A
Dimensions	W 66 x H 215 x D 38 mm
Material	Zinc Die casting
Ethernet port	M12 (Socket-Female), 4-pin, D-coded, Push-Pull Number of ports: 2 (IN/OUT) Supported function: daisy chain
Power supply port	Input: 7/8" (Plug-Male), 5-pin Output: 7/8" (Socket-Female), 5-pin Number of ports: 2 (IN/OUT) Supported function: daisy chain
PDCT port	M12 (Socket-Female), 5-pin, A-coded, Push-Pull Number of ports: 1 Connection method: USB serial communication
I/O port	M12 (Socket-Female), 5-pin, A-coded, Push-Pull Number of ports: 8
Mounting method	Mounting hole: fixed with M4 screw
Grounding method	Grounding hole: fixed with M4 screw
Unit weight (packaged)	\approx 700 g (\approx 900 g)
Comm. protocol	PROFINET, IO-Link

[Mode specifications]





Mode	Digital Input
Number of channels	16-CH (I/Q: 8-CH, C/Q: 8-CH)
I/O common	NPN / PNP
Input current	5 mA
ON voltage/current	Voltage: \geq 15 VDC \equiv Current: \geq 5 mA
OFF voltage	\leq 5 VDC \equiv
Mode	Digital Output
Number of channels	8-CH (C/Q)
I/O common	NPN / PNP
Power supply	24 VDC \equiv (18 - 30 VDC \equiv), Max. 300 mA
Leakage current	\leq 0.1 mA
Residual voltage	\leq 1.5 VDC \equiv
Short circuit protection	YES
Mode	IO-Link
Input current	2 mA
ON voltage / current	Voltage: \geq 15 VDC \equiv Current: \geq 2 mA
OFF voltage	\leq 5 VDC \equiv

[Environmental conditions]

Ambient temperature ⁰¹⁾	-5 to 70 °C, Storage: -25 to 70 °C (no freezing or condensation)
Ambient humidity	35 to 75%RH (no freezing or condensation)
Protection rating	IP67 (IEC standard)

01) UL approved ambient temperature: 45 °C

[Approvals]

Approval	  
Association approval	 IO-Link 



Slim Remote I/O

ARIO Series

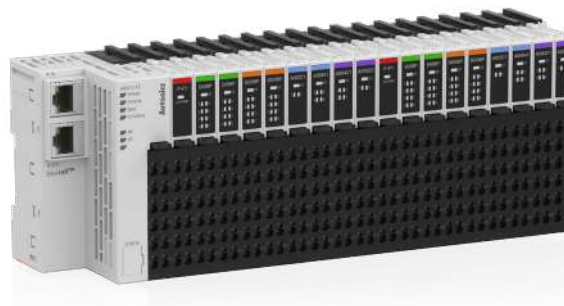

Features

- I/O supported based on industrial Ethernet / Fieldbus serial communication for Smart Factory
- Sequential multiple I/O distribution control via PLC, Industrial PC, etc.
- Coupler:
 - Supports a total of 8 different communications
 - EtherCAT, CC-Link, ProfiNet, ProfiBus, EtherNet/IP, DeviceNet, Modbus TCP compatible, Modbus RTU compatible
- Modules:
 - Various Input / Output Modules, Power Module
 - Remote ABUS / I/O power, Digital input / output (4 / 8 CH), Analog input / output (2 / 4 CH), Temperature input (4 CH)
 - Up to 64 modules can be extended (depending on communication)
- Hot-swap function:
 - Maintenance and setting can be restored automatically by replacing terminal and body during operation
- Push-in connection method:
 - Easy wire connection without tools helps reducing workload
- Expanded user convenience with DAQMaster, a device integration management program
 - Module setting, real time control and monitoring / diagnosis of input / output signal (except ARIO-C-PN / PB)
 - Product selection and placement through virtual mode, offering recommended sorting

Specifications

[Coupler]

Model	ARIO-C-EC	ARIO-C-CL	ARIO-C-PN	ARIO-C-PB
Protocol	EtherCAT	CC-Link	ProfiNet	Profibus
Transfer rate	100 Mbps	10 Mbps	100 Mbps	12 Mbps
Max. connections for modules	≤ 64	≤ 32	≤ 64	≤ 32
Memory map	1024 Byte	512 Byte	1024 Byte	488 Byte
Communication connector	RJ45 × 2	5-pin PCB	RJ45 × 2	9-pin D SUB
Setting connector	USB 2.0 type Micro B			
Model	ARIO-C-EI	ARIO-C-DN	ARIO-C-MT	ARIO-C-MR
Protocol	EtherNet/IP	DeviceNet	ModbusTCP compatible	ModbusRTU compatible
Transfer rate	10/100 Mbps	500 kbps	10/100 Mbps	115.2 kbps
Max. connections for modules	≤ 64	≤ 32	≤ 64	≤ 32
Memory map	1008 Byte	510 Byte	1024 Byte	512 Byte
Communication connector	RJ45 × 2	5-pin PCB	RJ45 × 2	5-pin PCB
Setting connector	USB 2.0 type Micro B			
Power supply	<ul style="list-style-type: none"> • ABUS (external consump.): 24 VDC\pm, ≤ 400 mA (≤ 9.6 W, coupler + module, ≤ 200 mA/CH, 2 CH/COM) • ABUS (internal supply): 5 VDC\pm, ≤ 960 mA (≤ 4.8 W, module) • I/O: 24 VDC\pm, ≤ 4,000 mA (≤ 96 W, ≤ 2,000 mA/CH, 2 CH/COM) 			
Power consumption	24 VDC \pm , standby/run: 200 mA, Max. load: 400 mA (coupler max. load)			

[Module]

Type	Digital input	Digital output
Model	ARIO-S-DI□□	ARIO-S-DO□□
Channel	4 CH, 8 CH model	
I/O common	NPN, PNP model	
I/O signal level	24 VDC \pm ± 10 %	
Input voltage	Turn ON: ≥ 7 VDC \pm Turn OFF: ≤ 0.4 VDC \pm	-
Output leakage voltage	-	≤ 1.2 VDC \pm
I/O current consumption	6 mA/CH	-
Rated output current	-	500 mA/CH
Power consumption	ABUS: 5 VDC \pm , ≤ 100 mA (≤ 0.5 W)	
On delay time	≤ 0.5 ms	
Off delay time	≤ 1.5 ms	
Internal transmission speed	4 Mbps	
Insulation	I/O to inner circuit: photocoupler insulated	

Type	Analog input			
Model	ARIO-S-AI□V1	ARIO-S-AI□V2	ARIO-S-AI□C1	ARIO-S-AI□C2
Channel	2 CH, 4 CH model			
Input method	Voltage input		Current input	
Input range	-10 to 10 VDC≐	0 to 10 VDC≐	0 to 20 mA	4 to 20 mA
Accuracy	<ul style="list-style-type: none"> Room temperature: PV ±0.3% F.S. Out of room temperature: PV ±0.6% F.S. 			
Input impedance	Min. 1 MΩ / Max. 250 Ω			
Status indicator ON	≤ -1 V or ≥ 1 V	≥ 1 V	≥ 1 mA	≥ 4 mA
Resolution	12-bit			
Power consumption	<ul style="list-style-type: none"> ABUS: 5 VDC≐, ≤ 180 mA (≤ 0.9 W) I/O: 24 VDC≐, ≤ 15 mA (≤ 0.36 W) 			
Internal transmission speed	4 Mbps			
Insulation	<ul style="list-style-type: none"> I/O to inner circuit: photocoupler insulated Between channels: non-insulated 			

Type	Analog output			
Model	ARIO-S-AO□V1	ARIO-S-AO□V2	ARIO-S-AO□C1	ARIO-S-AO□C2
Channel	2 CH, 4 CH model			
Output method	Voltage output		Current output	
Output range	-10 to 10 VDC≐	0 to 10 VDC≐	0 to 20 mA	4 to 20 mA
Accuracy	<ul style="list-style-type: none"> Room temperature: PV ±0.3% F.S. Out of room temperature: PV ±0.6% F.S. 			
Load resistance	Min. 5 kΩ / Max. 350 Ω			
Status indicator ON	≤ -1 V or ≥ 1 V	≥ 1 V	≥ 1 mA	Always ON
Resolution	12-bit			
Power consumption	<ul style="list-style-type: none"> ABUS: 5 VDC≐, ≤ 180 mA (≤ 0.9 W) I/O: 24 VDC≐, ≤ 15 mA (≤ 0.36 W) 		<ul style="list-style-type: none"> ABUS: 5 VDC≐, ≤ 100 mA (≤ 0.5 W) I/O: 24 VDC≐, ≤ 60 mA (≤ 1.44 W) 	
Internal transmission speed	4 Mbps			
Insulation	<ul style="list-style-type: none"> I/O to inner circuit: photocoupler insulated Between channels: non-insulated 			

Type	Temperature input	
Model	ARIO-S-AI04TC	ARIO-S-AI04RTD
Channel	4 CH	
Input method	Voltage input	Resistance input
Input range	Refer to the 'Input type and using range'	
Display accuracy ⁰¹⁾	(PV ±0.2% F.S. or ±2 °C, select the higher one) ±1-digit	(PV ±0.2% F.S.) ±1-digit
Status indicator ON	Temperature input within the rated range * No operation when the thermometer is not attached	
Resolution / Display	16-bit / 0.1 °C	
Power consumption	<ul style="list-style-type: none"> ABUS: 5 VDC≐, ≤ 180 mA (≤ 0.9 W) I/O: 24 VDC≐, ≤ 15 mA (≤ 0.36 W) 	
Internal transmission speed	4 Mbps	
Insulation	<ul style="list-style-type: none"> I/O to inner circuit: photocoupler insulated Between channels: non-insulated 	

01) Refer to the 'Measurement accuracy' below

[Common specifications]

Insulation resistance	≥ 100 MΩ (500 VDC≐ megger)
Dielectric strength	1000 VAC~ 50/60 Hz for 1 min
Noise immunity	500 VDC≐ the square wave noise (pulse width: 1 μs) by the noise simulator
Vibration	0.7 mm double amplitude at frequency of 10 to 55 Hz (for 1 min) in each X, Y, Z direction for 1 hour
Vibration (malfunction)	0.5 mm double amplitude at frequency of 10 to 55 Hz (for 1 min) in each X, Y, Z direction for 10 min
Shock	300 m/s ² (= 30 G) in each X, Y, Z direction for 3 times
Shock (malfunction)	100 m/s ² (= 10 G) in each X, Y, Z direction for 3 times
Ambient temperature	-10 to 55 °C, storage: -25 to 70 °C (no freezing or condensation)
Ambient humidity	35 to 85 %RH, storage: 35 to 85 %RH (no freezing or condensation)
Protection rating	IP20 (IEC standard)
Material	Terminal: PA6, body: MPPO, base: PA6, POM
Installation method	DIN rail mounting
Approval	CE, RoHS, REACH
Unit weight (packaged)	<ul style="list-style-type: none"> Coupler: ≈ 165 g (≈ 265 g) Module: ≈ 75 g (≈ 108 g)

DeviceNet

Remote I/O

(Standard Terminal Block Type)

ARD-D Series



Features

- Automatic communication speed recognition:
Enables to recognize communication speed automatically when connecting with master
- Network voltage monitoring:
If PV is lower than SV, enables to receive error flag for network power monitoring as Explicit message.
- Connect up to 3 expansion units
(expandable I/O points up to max. 64 points)
- Reading the number of expansion units:
Reads the number of connected expansion units
- Reading the unit specifications:
Reads the specifications of connected units

Specifications

Model	ARD-DI16□□	ARD-DO16□□	ARD-DX16□□	
I/O points	NPN or PNP input 16-point	NPN or PNP output 16-point	NPN or PNP I/O each 8-point (total 16 -point)	
Control I/O	Voltage	10-28 VDC=	10-28 VDC= (voltage drop: ≤ 0.5 VDC=)	
	Current	10 mA/point	0.5 A/point (leakage current: ≤ 0.5 mA)	
	COMMON method	8-point, common		
Protection circuit	Surge, short-circuit and overheat protection, reverse power protection circuit, overcurrent protection circuit (NPN type: operate at ≥ 1.9 A, PNP type: operate at ≥ 0.7 A)			
Approval	CE EAC DeviceNet			
Unit weight	≈ 140 g			
Model	ARD-DI08A□	ARD-DO08S□	ARD-DO08R□	
I/O points	AC input 8-point	SSR output 8-point	Relay output 8-point	
Control I/O	Voltage	75-250 VAC~	30-250 VAC~	N.O. (Normally Open) 250 VAC~ 2A, 1a
	Current	13 mA/point	1 A/point	
	COMMON method	8-point, common		1 point, 1 COM
Protection circuit	Surge, reverse power protection circuit			
Approval	EAC DeviceNet			
Unit weight	≈ 150 g	≈ 170 g	≈ 160 g	
Power supply	Rated voltage: 24 VDC=, voltage range: 12-28 VDC=			
Power consumption	≤ 3 W			
Number of connected expansion unit	8-point type: ≤ 7 units, 16-point type: ≤ 3 units			
I/O points	≤ 64-point			
Communication spec.	I/O Slave messaging (group 2 only slave) : supporting Poll command, Bit_strobe command, Cyclic command, COS command			
Communication speed (comm. distance)	125 kbps (≤ 500 m), 250 kbps (≤ 250 m), 500 kbps (≤ 100 m)			
Protocol	DeviceNet			
Approval	ODVA Conformance tested			
Insulation method	I/O and internal circuit: photocoupler insulation, DeviceNet and internal circuit: non-insulation, DeviceNet power: non-insulation			
Insulation resistance	≥ 200 MΩ (500 VDC= megger)			
Noise immunity	±240 VDC= the square wave noise (pulse width: 1 μs) by the noise simulator			
Dielectric strength	1,000 VAC~ at 50/60 Hz for 1 min			
Vibration	1.5 mm amplitude at frequency 10 to 55 Hz (for 1 min) in each X, Y, Z direction for 2 hours			
Shock	500 m/s ² (≈ 50 G) in each X, Y, Z direction for 3 times			
Ambient temperature	-10 to 55 °C, storage: -25 to 75 °C (no freezing or condensation)			
Ambient humidity	35 to 85 %RH, storage: 35 to 85 %RH (no freezing or condensation)			
Protection rating	IP20 (IEC standard)			
Indicator	Network status (NS) and unit status (MS) indicator (green, red LED), I/O status indicator (input: green LED, output: red LED)			
Material	Front and body case: PC, rubber cap: NBR			
Mounting method	DIN rail or panel mounting			

DeviceNet

Remote I/O

(Sensor Connector Type)

ARD-D Series



Features

- Automatic communication speed recognition:
Enables to recognize communication speed automatically when connecting with master
- Network voltage monitoring:
If PV is lower than SV, enables to receive error flag for network power monitoring as Explicit message.
- Connect up to 7 expansion units
(expandable I/O points up to max. 64 points)
- Reading the number of expansion units:
Reads the number of connected expansion units
- Reading model name:
Reads the connected model name of connected units
- Reading the unit specifications:
Reads the specifications of connected units

Specifications

Model	AR□-DI08□-4S	AR□-DO08□-4S
Power supply	Rated voltage: 24 VDC≒, voltage range: 12-28 VDC≒	
Power consumption	≤ 3 W	
I/O points	NPN or PNP input 8-point	NPN or PNP output 8-point
Control I/O	Voltage	10-28 VDC≒ input
	Current	10 mA/point (sensor current: 150 mA/point)
	COMMON method	8-point, common
Number of connected expansion unit	≤ 7 units	
I/O points	≤ 64-point	
Communication spec.	I/O Slave messaging (group 2 only slave) : supporting Poll command, Bit_strobe command, Cyclic command, COS command	
Communication speed (comm. distance)	125 kbps (≤ 500 m), 250 kbps (≤ 250 m), 500 kbps (≤ 100 m)	
Protocol	DeviceNet	
Approval	ODVA Conformance tested	
Insulation method	I/O and internal circuit: photocoupler insulation, DeviceNet and internal circuit: non-insulation, DeviceNet power: non-insulation	
Insulation resistance	≥ 200 MΩ (500 VDC≒ megger)	
Noise immunity	±240 VDC≒ the square wave noise (pulse width: 1 μs) by the noise simulator	
Dielectric strength	1,000 VAC~ at 50/60 Hz for 1 min	
Vibration	1.5 mm amplitude at frequency 10 to 55 Hz (for 1 min) in each X, Y, Z direction for 2 hours	
Shock	500 m/s ² (≈ 50 G) in each X, Y, Z direction for 3 times	
Ambient temperature	-10 to 55 °C, storage: -25 to 75 °C (a non freezing or condensation environment)	
Ambient humidity	35 to 85 %RH, storage: 35 to 85 %RH (a non freezing or condensation environment)	
Protection structure	IP20 (IEC standard)	
Protection circuit	Surge, short-circuit, overheat and ESD protection, reverse power protection circuit	
Indicator	Overcurrent protection circuit (operation : ≥ 0.17 A)	Overcurrent protection circuit (operation: ≥ 0.7 A)
	Network status (NS) and unit status (MS) indicator (green, red LED), I/O status indicator (input: green LED, output: red LED)	
Material	Front and body case: PC	
Mounting method	DIN rail or panel mounting	
Approval	CE ENEC DeviceNet	
Unit weight	Basic unit	≈ 64 g
	Expansion unit	NPN type: ≈ 56 g PNP type: ≈ 57 g
		NPN type: ≈ 65 g PNP type: ≈ 67 g
		NPN type: ≈ 58 g PNP type: ≈ 59 g

DeviceNet

Remote I/O

(Analog, Terminal Block Type)

ARD-A Series



Features

- Adopts DeviceNet, standard open Network
 - : Communicates other DeviceNet devices without additional installation
 - : Configurable power and communication system only with communication cables
 - : Connectible max. 63 units per 1 master unit
- Strong against noise and high accuracy (0.3 %) measurement with differential input method (measuring difference between +, - input signal)
- Various I/O range:
 - 0-5 VDC \rightleftharpoons , 1-5 VDC \rightleftharpoons , 0-10 VDC \rightleftharpoons , -5-5 VDC \rightleftharpoons , -10-10 VDC \rightleftharpoons , DC 4-20 mA, DC 0-20 mA
- Scale function:
 - Settable high / low limit scale value for analog I/O range (setting range: -28,000 to 28,000)
- Various functions:
 - Automatic communication speed recognition, Network voltage monitoring, Input digital filter, Peak / Bottom Hold, hysteresis, reading model name and number of units, I/O and status flag monitoring
- Built-in surge, ESD protection, reverse polarity protection circuit
- Mounting DIN rail and panel method

Specifications

Model	ARD-AI04	ARD-AO04
Power supply	Rated voltage: 24 VDC \rightleftharpoons , voltage range: 12-28 VDC \rightleftharpoons	
Power consumption	\leq 3 W	
Output points	Input 4-point (switchable voltage/current)	Output 4-point (voltage 2 CH, current 2 CH)
Control I/O	Voltage	0-10 VDC \rightleftharpoons , -10-10 VDC \rightleftharpoons , 0-5 VDC \rightleftharpoons , 1-5 VDC \rightleftharpoons , -5-5 VDC \rightleftharpoons (input impedance: \geq 1 M Ω)
	Current	DC 4-20 mA, DC 0-20 mA (input impedance: 250 Ω)
	Max. allowable I/O	\pm 5 % F.S. of I/O range
	Resolution	14 bits, 1/16,000
	Accuracy	At room temperature (25 $^{\circ}$ C \pm 5 $^{\circ}$ C) range: \pm 0.3 % F.S. Out of room temperature range: \pm 0.6 % F.S.
Communication spec.	I/O Slave messaging (group 2 only slave) : supporting Poll command, Bit_strobe command, Cyclic command, COS command	
Communication speed (comm. distance)	125 kbps (\leq 500 m), 250 kbps (\leq 250 m), 500 kbps (\leq 100 m)	
Protocol	DeviceNet	
Insulation method	I/O and internal circuit: non-insulation, DeviceNet and internal circuit: insulation, DeviceNet power: insulation	
Insulation resistance	\geq 200 M Ω (500 VDC \rightleftharpoons megger)	
Noise immunity	\pm 500 VDC \rightleftharpoons the square wave noise (pulse width: 1 μ s) by the noise simulator	
Dielectric strength	500 VAC \sim at 50/60 Hz for 1 min (between external terminals and case, between output terminals and power terminals)	
Vibration	1.5 mm amplitude at frequency 10 to 55 Hz (for 1 min) in each X, Y, Z direction for 2 hours	
Shock	500 m/s 2 (\approx 50 G) in each X, Y, Z direction for 3 times	
Ambient temperature	-10 to 50 $^{\circ}$ C, storage: -25 to 75 $^{\circ}$ C (no freezing or condensation)	
Ambient humidity	35 to 85 %RH, storage: 35 to 85 %RH (no freezing or condensation)	
Protection rating	IP20 (IEC standard)	
Protection circuit	Surge and ESD protection, reverse power protection circuit	
Indicator	Network status (NS) and unit status (MS) indicator (green, red LED)	
Material	Front and body case: PC	
Mounting method	DIN rail or panel mounting	
Approval	CE ENEC DeviceNet	CE ENEC DeviceNet compatible
Unit weight (packaged)	\approx 145 g (\approx 210 g)	\approx 145 g (\approx 210 g)

Modbus

Remote I/O

ARM Series



Features

- Modbus RTU standard protocol
- Saving work time for wiring with sensor connector (CNE series, sold separately)
- Compact size
 - : Small size with W 26 × L 76 × H 54 mm to install at narrow space
 - : Available DIN Rail mounting and panel mounting method
- Low-speed (16 bit / 30 CPS) counter function
- Real-time monitoring by various functions
 - : Communication speed auto-recognition
 - : Reading number of expansion units and specifications, Reading model name of basic and expansion units
 - : Monitoring Single byte input / output, Multi byte input / output and status Flag
- Easy expansion
 - : Available to connect up to 63 basic units per 1 master unit
 - : Available to connect up to 7 expansion units per 1 basic units (controllable input / output for max. 64 points)
 - : Combines the desired specifications of input / output by various input / output units
 - : Organizes power and communication system by only communication cable lines
- High reliability:
 - Built-in surge, short, overheat, reverse power polarity and ESD protection circuits

Specifications

Model	AR□-DI08□-4S	AR□-DO08□-4S
Power supply	Rated voltage: 24 VDC \equiv , voltage range: 12-28 VDC \equiv	
Power consumption	≤ 3 W	
I/O points	NPN or PNP input 8-point	NPN or PNP output 8-point
Control I/O	Voltage	10-28 VDC \equiv input
	Current	10 mA/point (sensor current: 150 mA/point)
	COMMON method	8-point, common
Number of connected expansion unit	≤ 7 units	
I/O points	≤ 64-point	
Counter function ⁰¹⁾	16 bits low-speed counter (30 CPS)	-
Insulation method	I/O and internal circuit: photocoupler insulation, Modbus to internal bus and internal circuit: insulation, unit power: non-insulation	
Insulation resistance	≥ 200 M Ω (500 VDC \equiv megger)	
Noise immunity	±240 VDC \equiv the square wave noise (pulse width: 1 μ s) by the noise simulator	
Dielectric strength	1,000 VAC \sim at 50/60 Hz for 1 min	
Vibration	1.5 mm amplitude at frequency 10 to 55 Hz (for 1 min) in each X, Y, Z direction for 2 hours	
Shock	500 m/s ² (\approx 50 G) in each X, Y, Z direction for 3 times	
Ambient temperature	-10 to 55 °C, storage: -25 to 75 °C (no freezing or condensation)	
Ambient humidity	35 to 85 %RH, storage: 35 to 85 %RH (no freezing or condensation)	
Protection rating	IP20 (IEC standard)	
Protection circuit	Surge, short-circuit, overheat and ESD protection, reverse power protection circuit	
Indicator	Overcurrent protection circuit (operation: ≥ 0.17 A)	Overcurrent protection circuit (operation: ≥ 0.7 A)
	Network status (NS) and unit status (MS) indicator (green, red LED), I/O status indicator (input: green LED, output: red LED)	
Material	Front and body case: PC	
Mounting method	DIN rail or panel mounting	
Approval	CE ENEC	
Unit weight (packaged)	Basic unit	≈ 61.8 g (\approx 123.3 g)
	Expansion unit	≈ 61.8 g (\approx 123.3 g)
Comm. protocol	NPN type: ≈ 56 g (\approx 117.5 g)	NPN type: ≈ 58 g (\approx 119.5 g)
	PNP type: ≈ 57 g (\approx 118.5 g)	PNP type: ≈ 59 g (\approx 120.5g)

01) CPS (counter per second): Specification of accepting external signals per second
The digital output type is available to use the counter when using with digital input type.



H3. Signal Conditioners

Converters are devices which convert voltage, current, RTD, and TC input into assigned voltage, current or alarm outputs.

Isolated Converters

CN-6000 Series



Features

- Multi-input
 - CN-610□-□: Thermocouple 12 types, RTD 5 types, Analog (mV, V, mA) 6 types
 - CN-640□-□: 0 to 50.00kHz
- Improved visibility with negative LCD:
 - 12 segment, 3 colors (selectable red, green, yellow)
- Displays input type and unit on display part
- Various outputs
 - Alarm output: 1 EA / 2 EA / 4 EA
 - 0 - 20 mA transmission output (adjustable insulation, output range), 0 - 10 VDC \rightleftharpoons voltage output (adjustable insulation, output range)
- Various functions
 - High / Low peak input monitoring
 - Alarm output (upper / lower, sensor break)
 - Transmission output / display scale
 - Digital input key (DI), etc.
- Built-in power supply for sensor / transmitter (24 VDC \rightleftharpoons)

Specifications

Model	CN-610□-□	CN-640□-□
Input type ⁰¹⁾	Universal - Temperature sensor : RTD, thermocouple - Analog: voltage, current	Pulse
Display method	12-segment (selectable red, green, yellow) LCD (character size: 6.4 × 11.0 mm), Graphic bar and input type / unit display part (red) LCD (character size: 1.4 × 2.75 mm)	
Display accuracy ⁰²⁾	Dependent on the ambient temperature	
25 ± 5°C	± 0.2 % F.S. ± 1 digit	
-10 to 20°C, 30 to 50°C	± 0.3 % F.S. ± 1 digit	
Display cycle ⁰³⁾	-	Same with pulse input cycle
Sampling cycle	Temperature sensor input: 250 ms Analog input: 100 ms	-
Unit weight (packaged)	≈ 160 g (≈ 301 g)	≈ 200 g (≈ 340 g)
Approval	CE ENEC	

01) For details, refer to the input type and range.

02) Thermocouple, below -100 °C: ± 0.4 % F.S. ± 1 digit
Thermocouple T, U: min. ± 2.0 °C

03) When pulse input cycle is over 10 sec, it is updated by every 10 sec.

Output	Transmission (DC 0 - 20 mA)	Transmission (0 - 10 VDC \rightleftharpoons)	Alarm
Load resistance	≤ 600Ω	≥ 10 kΩ	-
Accuracy	± 0.3 F.S.		-
Resolution	8,000		-
Contact capacity	-		250 VAC~
Contact composition	-		5 A, 1a: 1 / 3 A, 1c: 2 / 5 A, 1a: 4 model
Power supply	100 - 240 VAC~ ± 10 % 50 / 60 Hz	24 VDC \rightleftharpoons ± 10 %	
Power consumption	≤ 8 VA	≤ 3 W	
Insulation resistance	≥ 100 MΩ (500 VDC \rightleftharpoons megger)		
Dielectric strength	Between input terminal and power terminal: 2,000 VAC~ 50 / 60 Hz for 1 min		
Vibration	0.75 mm double amplitude at frequency of 5 to 55 Hz (for 1 minute) in each X, Y, Z direction for 2 hours		
Noise immunity	± 2 kV the square wave noise (pulse width: 1 μs) by the noise simulator		
Memory retention	≈ 10 years (non-volatile semiconductor memory type)		
Ambient temperature	-10 to 50 °C, storage: -20 to 60 °C (no freezing or condensation)		
Ambient humidity	35 to 85 %RH, storage: 35 to 85 %RH (no freezing or condensation)		

I. Connectivity

Connectivity devices are communication devices used to send and receive signals or data between the environment and information processing systems.

1. I/O Terminal Blocks
2. Distribution Boxes
3. Sockets
4. Connectors
5. Cables

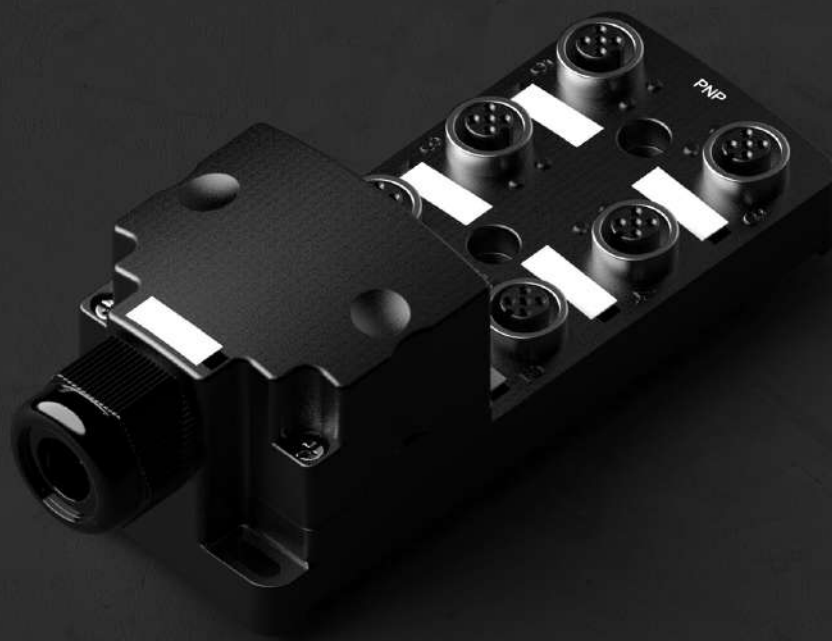

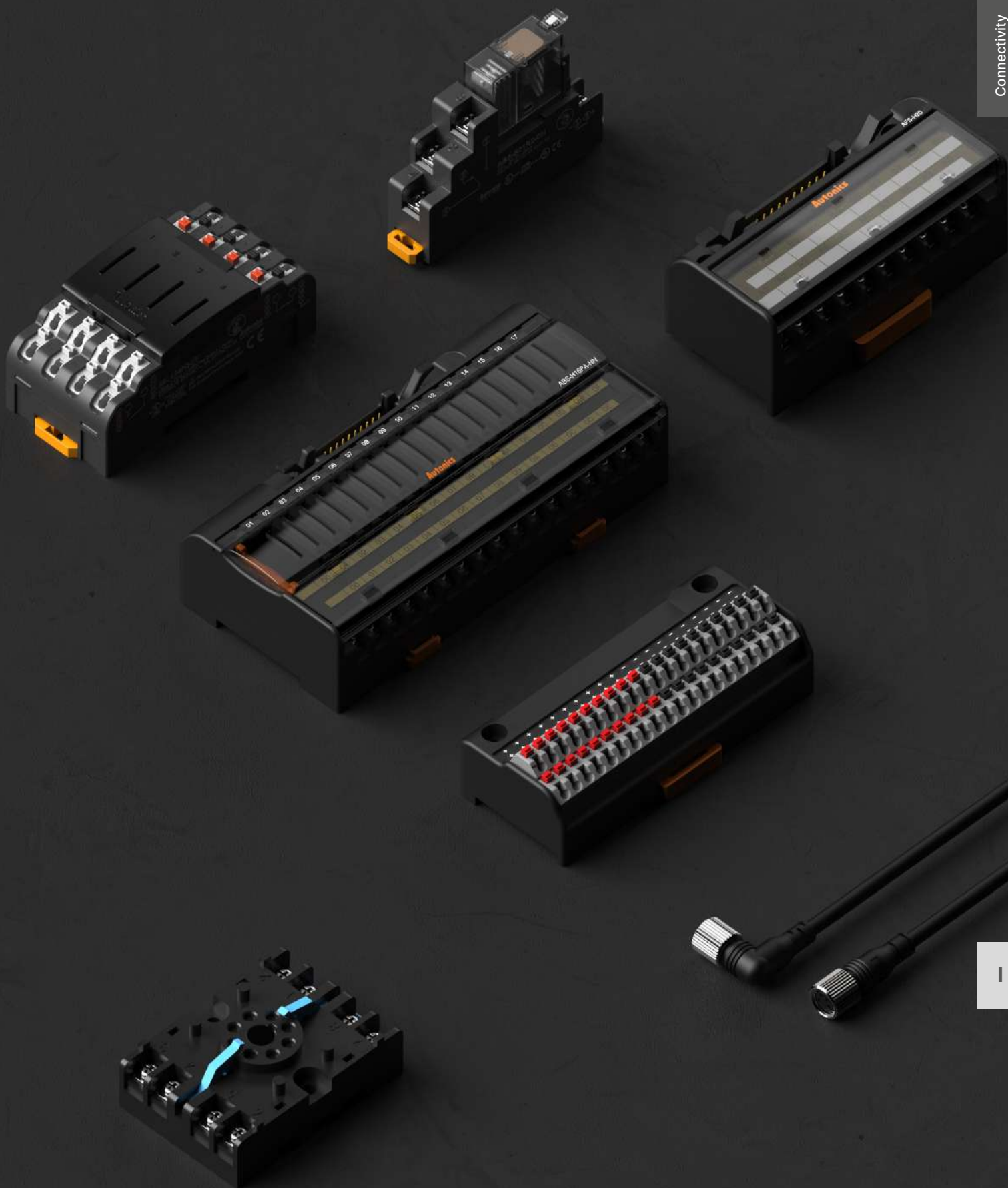



11. I/O Terminal Blocks

I/O terminal blocks are widely used to connect various devices in a industrial environments and accomplish ideal system configurations.

I1-1	Interface	AFL Series	Screwless Interface Terminal Blocks
		AFR Series	Rising Clamp Interface Terminal Blocks
		AFS Series	Interface Terminal Blocks
I1-2	Common	ACL Series	Screwless Common Terminal Blocks
		ACR Series	Rising Clamp Common Terminal Blocks
		ACS Series	Common Terminal Blocks
I1-3	Relay	ABL Series	Screwless Relay Terminal Blocks (16-Point)
			Screwless Relay Terminal Blocks (4-Point)
			Screwless Relay Terminal Blocks (1-Point)
		ABS Series	Relay Terminal Blocks (4 / 16 / 32-Point)
			Relay Terminal Blocks (1-Point)
I1-4	Solid State Relay	ASL Series	Screwless SSR Terminal Blocks (16-Point)
			Screwless SSR Terminal Blocks (4-Point)
			Screwless SSR Terminal Blocks (1-Point)
I1-5	Sensor Connector	AFE Series	Sensor Connector Terminal Blocks

Screwless Interface Terminal Blocks

AFL Series



Features

- Screwless push-in type connection for simple and easy connection
- Slim and compact design with 5mm terminal pitch
- Ideal for connector type PLCs and dedicated controller I/O
- DIN rail mount and screw mount methods

Specifications

Model	AFL-H20	AFL-H26	AFL-H40	AFL-H50	AFL-H50B
The number of connector pin	20	26	40	50	50
The number of terminal	20	26	40	50	50
Terminal type	Screwless	Screwless	Screwless	Screwless	Screwless
Terminal pitch	5.0 mm	5.0 mm	5.0 mm	5.0 mm	5.0 mm
Connector for controller side	20-pin Omron (XG4A-2031)	26-pin Omron (XG4A-2631)	40-pin Hirose (HIF3BA-40PA-54DSA)	50-pin Hirose (HIF3BA-50PA-2.54DSA)	50-pin Hirose (HIF3BB-50PA-2.54DSA)
Material	Case, Base: PC				
Approval	CE ENEC		CE ENEC	CE ENEC	CE ENEC
Unit weight (packaged)	≈ 48.5 g (≈ 86.2 g)	≈ 60 g (≈ 89 g)	≈ 89 g (≈ 156 g)	≈ 110 g (≈ 177 g)	≈ 110 g (≈ 177 g)

Model	AFL-H20-LN, AFL-H20-LP	AFL-H40-LN, AFL-H40-LP
The number of connector pin	20	40
The number of terminal	16 ⁰¹⁾	32 ⁰²⁾
Terminal type	Screwless	Screwless
Terminal pitch	5.0 mm	5.0 mm
Connector for controller side	20-pin Omron (XG4A-2031)	40-pin Hirose (HIF3BA-40PA-2.54DSA)
Input logic	NPN / PNP model	
Indicator	Power indicator: red, operation indicator: blue	
Material	Case, Base: PC	
Approval	CE ENEC	CE ENEC
Unit weight (packaged)	≈ 48.6 g (≈ 86.3 g)	≈ 91 g (≈ 158 g)

01) Four terminals among twenty terminals are used for LED power.

02) Eight terminals among forty terminals are used for LED power or N.C (Not Connected) terminals.

Rated voltage ⁰¹⁾	Basic model: ≤ 125 VDC≒, 125 VAC~ 50/60 Hz Indicator equipped model: ≤ 24 VDC≒ ± 10%
Rated current	≤ 1 A
Insulation resistance	≥ 1,000 MΩ (500 VDC≒ megger)
Dielectric strength	2,700 VAC~ 50/60 Hz for 1 minute
Vibration	0.75 mm amplitude at frequency of 10 to 55 Hz (for 1 minute) in each X, Y, Z direction for 2 hours
Vibration (malfunction)	0.75 mm amplitude at frequency of 10 to 55 Hz (for 1 minute) in each X, Y, Z direction for 10 minutes
Shock	150 m/s ² (≈ 15 G) in each X, Y, Z direction for 3 times
Shock (malfunction)	100 m/s ² (≈ 10 G) in each X, Y, Z direction for 3 times
Ambient temperature	-15 to 55 °C, storage: -25 to 65 °C (no freezing or condensation)
Ambient humidity	35 to 85 %RH, storage: 35 to 85 %RH (no freezing or condensation)
Protection structure	IP20 (IEC standard)

01) When connecting loads to output part, connect loads of same power type. Connecting loads of different power type may cause safety issues.

Applicable wire- solid ⁰¹⁾	∅ 0.6 to 1.25 mm
Applicable wire - stranded ⁰¹⁾⁰²⁾	AWG 22-18 (0.30 to 0.80 mm ²)
Wire ferrule connection tensile strength	≥ 30 N
Stripped length	8 to 10 mm

01) Use the cable of copper conductor in 60 °C temperature class.

02) When using the stranded wire, use End Sleeve (wire ferrule).

Rising Clamp Interface Terminal Blocks

AFR Series



Features

- Rising clamp type connection method offers simple, easy and durable connection
- Slim and compact design with 5mm terminal pitch
- Ideal for connector type PLCs and dedicated controller I/O
- DIN rail mount and screw mount methods

Specifications

Model	AFR-H20	AFR-H26	AFR-H40	AFR-H50	AFR-H50B
The number of connector pin	20	26	40	50	50
The number of terminal	20	26	40	50	50
Terminal type	Rising Clamp	Rising Clamp	Rising Clamp	Rising Clamp	Rising Clamp
Terminal pitch	5.0 mm	5.0 mm	5.0 mm	5.0 mm	5.0 mm
Connector for controller side	20-pin Omron (XG4A-2031)	26-pin Omron (XG4A-2631)	40-pin Hirose (HIF3BA-40PA-54DSA)	50-pin Hirose (HIF3BA-50PA-2.54DSA)	50-pin Hirose (HIF3BB-50PA-2.54DSA)
Material	Case, Base: PC				
Approval	CE ENEC	CE	CE ENEC	CE ENEC	CE ENEC
Unit weight (packaged)	≈ 61 g (≈ 98.7 g)	≈ 78 g (≈ 107 g)	≈ 116 g (≈ 183 g)	≈ 143 g (≈ 210 g)	≈ 143 g (≈ 210 g)

Model	AFR-H20-LN, AFR-H20-LP	AFR-H40-LN, AFR-H40-LP
The number of connector pin	20	40
The number of terminal	16 ⁰¹⁾	32 ⁰²⁾
Terminal type	Rising Clamp	Rising Clamp
Terminal pitch	5.0 mm	5.0 mm
Connector for controller side	20-pin Omron (XG4A-2031)	40-pin Hirose (HIF3BA-40PA-2.54DSA)
Input logic	NPN / PNP model	
Indicator	Power indicator: red, operation indicator: blue	
Material	Case, Base: PC	
Approval	CE ENEC	CE ENEC
Unit weight (packaged)	≈ 61.1 g (≈ 98.8 g)	≈ 118 g (≈ 188 g)

01) Four terminals among twenty terminals are used for LED power.

02) Eight terminals among forty terminals are used for LED power or N.C (Not Connected) terminals.

Rated voltage ⁰¹⁾	Basic model: ≤ 125 VDC≡, 125 VAC~ 50/60 Hz Indicator equipped model: ≤ 24 VDC≡ ± 10%
Rated current	≤ 1 A
Insulation resistance	≥ 1,000 MΩ (500 VDC≡ megger)
Dielectric strength	2,700 VAC~ 50/60 Hz for 1 minute
Vibration	0.75 mm amplitude at frequency of 10 to 55 Hz (for 1 minute) in each X, Y, Z direction for 2 hours
Vibration (malfunction)	0.75 mm amplitude at frequency of 10 to 55 Hz (for 1 minute) in each X, Y, Z direction for 10 minutes
Shock	150 m/s ² (≈ 15 G) in each X, Y, Z direction for 3 times
Shock (malfunction)	100 m/s ² (≈ 10 G) in each X, Y, Z direction for 3 times
Ambient temperature	-15 to 55 °C, storage: -25 to 65 °C (no freezing or condensation)
Ambient humidity	35 to 85 %RH, storage: 35 to 85 %RH (no freezing or condensation)
Protection structure	IP20 (IEC standard)
Applicable wire - solid ⁰¹⁾	Ø 0.3 to 1.2 mm
Applicable wire - stranded ^{01) 02)}	AWG 22-16 (0.30 to 1.25 mm ²)
Wire ferrule connection tensile strength	≥ 30 N
Stripped length	6 to 8 mm

01) Use the cable of copper conductor in 60 °C temperature class.

02) When using the stranded wire, use End Sleeve (wire ferrule).

Interface Terminal Blocks

AFS Series



Features

- Compact interface terminal blocks with 7 mm terminal pitch
- Optimized for connector type PLCs and input / output of dedicated controllers
- Compact, space-saving design
- DIN rail mount and screw mount methods

Specifications

Model	AFS-H20	AFS-H26	AFS-H40	AFS-HB40	AFS-H50
The number of connector pin	20	26	40	40	50
The number of terminal	20	26	40	40	50
Terminal type	Screw	Screw	Screw	Screw	Screw
Terminal block arrangement	Single line	Single line	Single line	Double line	Single line
Terminal pitch	7.0 mm	7.1 mm	7.0 mm	7.2 mm	7.0 mm
Connector for controller side	20-pin Hirose (HIF3BA-20PA-2.54DSA)	26-pin Omron (XG4A-2631)	40-pin Hirose (HIF3BA-40PA-2.54DSA)	40-pin Omron (XG4A-4031)	50-pin Hirose (HIF3BA-50PA-2.54DSA)
Material	Case, Base: MPPPO, terminal: brass	Case, Base: PC, terminal: brass	Case, Base: MPPPO, terminal: brass	Case, Base: PC, terminal: brass	Case, Base: MPPPO, terminal: brass
Approval	CE, UL, ENEC, EAC	CE, UL, ENEC	CE, UL, ENEC, EAC	CE, UL, ENEC	CE, UL, ENEC, EAC
Unit weight (packaged)	≈ 71 g (≈ 103 g)	≈ 93 g (≈ 133 g)	≈ 133 g (≈ 175 g)	≈ 142 g (≈ 194 g)	≈ 163 g (≈ 211 g)
Rated voltage ⁰¹⁾	≤ 125 VDC=, 125 VAC~ 50/60 Hz				
Rated current	≤ 1 A				
Insulation resistance	≥ 1,000 MΩ (500 VDC= megger)				
Dielectric strength	2,700 VAC~ 50/60 Hz for 1 minute				
Vibration	0.75 mm amplitude at frequency of 10 to 55 Hz (for 1 minute) in each X, Y, Z direction for 2 hours				
Vibration (malfunction)	0.75 mm amplitude at frequency of 10 to 55 Hz (for 1 minute) in each X, Y, Z direction for 10 minutes				
Shock	150 m/s ² (≈ 15 G) in each X, Y, Z direction for 3 times				
Shock (malfunction)	100 m/s ² (≈ 10 G) in each X, Y, Z direction for 3 times				
Ambient temperature	-15 to 55 °C, storage: -25 to 65 °C (no freezing or condensation)				
Ambient humidity	35 to 85 %RH, storage: 35 to 85 %RH (no freezing or condensation)				
Protection structure	IP20 (IEC standard)				
Applicable wire - solid	Ø 0.3 to 1.2 mm				
Applicable wire - stranded	AWG 22-16 (0.30 to 1.25 mm ²)				
Crimp terminal connection tensile strength	≥ 30 N				
Tightening torque	0.5 to 0.6 N·m				

01) When connecting loads to output part, connect loads of same power type. Connecting loads of different power type may cause safety issues.

Screwless Common Terminal Blocks

ACL Series



Features

- Screwless push-in type for simple and easy connection
- No jumper bars required due to built-in common PCB
- For use as power supply expansion terminals
- Slim and compact design with 5mm terminal pitch
- DIN rail mount and screw mount methods

Specifications

Model	ACL-20□	ACL-40□	ACL-B40□	ACL-50□
The number of terminal	20	40	40	50
Terminal type	Screwless	Screwless	Screwless	Screwless
Terminal block arrangement	Single line	Single line	Double line	Single line
Terminal pitch	5.0 mm	5.0 mm	5.0 mm	5.0 mm
Material	Case, Base: PC	Case, Base: PC	Case, Base: PC	Case, Base: PC
Approval	CE ENEC	CE ENEC	CE	CE ENEC
Unit weight (packaged)	≈ 42 g (≈ 71 g)	≈ 79 g (≈ 146 g)	≈ 67 g (≈ 96 g)	≈ 97 g (≈ 164 g)
Rated voltage	≤ 250 VDC≡, 250 VAC~ 50/60 Hz			
Rated current	≤ 10 A			
Insulation resistance	≥ 1,000 MΩ (500 VDC≡ megger)			
Dielectric strength	3,000 VAC~ 50/60 Hz for 1 minute			
Vibration	0.75 mm amplitude at frequency of 10 to 55 Hz (for 1 minute) in each X, Y, Z direction for 2 hours			
Vibration (malfunction)	0.75 mm amplitude at frequency of 10 to 55 Hz (for 1 minute) in each X, Y, Z direction for 10 minutes			
Shock	150 m/s ² (≈ 15 G) in each X, Y, Z direction for 3 times			
Shock (malfunction)	100 m/s ² (≈ 10 G) in each X, Y, Z direction for 3 times			
Ambient temperature	-15 to 55 °C, storage: -25 to 65 °C (no freezing or condensation)			
Ambient humidity	35 to 85 %RH, storage: 35 to 85 %RH (no freezing or condensation)			
Protection structure	IP20 (IEC standard)			
Applicable wire - solid ⁰¹⁾	Ø 0.6 to 1.25 mm			
Applicable wire - stranded ^{01) 02)}	AWG 22-18 (0.30 to 0.80 mm ²)			
Wire ferrule connection tensile strength	≥ 30 N			
Stripped length	8 to 10 mm			

01) Use the cable of copper conductor in 60 °C temperature class.

02) When using the stranded wire, use End Sleeve (wire ferrule).

Rising Clamp

Common

Terminal Blocks





ACR Series



Features

- Rising clamp type connection for simple and easy connection
- No jumper bars required due to built-in common PCB
- For use as power supply expansion terminals
- Slim and compact design with 5 mm terminal pitch
- DIN rail mount and screw mount methods

Specifications

Model	ACR-20□	ACR-40□	ACR-B40□	ACR-50□
The number of terminal	20	40	40	50
Terminal type	Rising Clamp	Rising Clamp	Rising Clamp	Rising Clamp
Terminal block arrangement	Single line	Single line	Double line	Single line
Terminal pitch	5.0 mm	5.0 mm	5.0 mm	5.0 mm
Material	Case, Base: PC	Case, Base: PC	Case, Base: PC	Case, Base: PC
Approval	CE  ENEC (ACR-20T)	CE  ENEC (ACR-40T)	CE 	CE  ENEC (ACR-50T)
Unit weight (packaged)	≈ 55 g (≈ 84 g)	≈ 105 g (≈ 172 g)	≈ 92 g (≈ 121 g)	≈ 130 g (≈ 197 g)
Rated voltage ⁰¹⁾	≤ 250 VDC \equiv , 250 VAC~ 50/60 Hz			
Rated current	≤ 10 A			
Insulation resistance	≥ 1,000 MΩ (500 VDC \equiv megger)			
Dielectric strength	3,000 VAC~ 50/60 Hz for 1 minute			
Vibration	0.75 mm amplitude at frequency of 10 to 55 Hz (for 1 minute) in each X, Y, Z direction for 2 hours			
Vibration (malfunction)	0.75 mm amplitude at frequency of 10 to 55 Hz (for 1 minute) in each X, Y, Z direction for 10 minutes			
Shock	150 m/s ² (≈ 15 G) in each X, Y, Z direction for 3 times			
Shock (malfunction)	100 m/s ² (≈ 10 G) in each X, Y, Z direction for 3 times			
Ambient temperature	-15 to 55 °C, storage: -25 to 65 °C (no freezing or condensation)			
Ambient humidity	35 to 85 %RH, storage: 35 to 85 %RH (no freezing or condensation)			
Protection structure	IP20 (IEC standard)			
Applicable wire - solid ⁰¹⁾	Ø 0.6 to 1.25 mm			
Applicable wire - stranded ^{01) 02)}	AWG 22-16 (0.30 to 1.25 mm ²)			
Wire ferrule connection tensile strength	≥ 30 N			
Stripped length	8 to 10 mm			

01) UL approved rated voltage of ACR-□L (single line) model is 30 VDC \equiv , 30 VAC~ which excludes the field wire.

01) Use the cable of copper conductor in 60 °C temperature class.

02) When using the stranded wire, use End Sleeve (wire ferrule).

Common Terminal Blocks

ACS Series



Features

- Compact common terminal blocks with 7 mm terminal pitch
- No jumper bars required due to built-in common PCB
- For use as power supply expansion terminals
- Compact, space-saving design
- DIN rail mount and screw mount methods

Specifications

Model	ACS-20□	ACS-40□	ACS-B40□	ACS-50□
The number of terminal	20	40	40	50
Terminal type	Screw	Screw	Screw	Screw
Terminal block arrangement	Single line	Single line	Double line	Single line
Terminal pitch	7.0 mm	7.0 mm	7.2 mm	7.0 mm
Material	Case, Base: MPPO, terminal: brass	Case, Base: MPPO, terminal: brass	Case, Base: PC, terminal: brass	Case, Base: MPPO, terminal: brass
Approval	CE, RoHS, ENEC	CE, RoHS, ENEC	CE, RoHS	CE, RoHS, ENEC
Unit weight (packaged)	≈ 61 g (≈ 92 g)	≈ 115 g (≈ 157 g)	≈ 120 g (≈ 149 g)	≈ 141 g (≈ 189 g)
Rated voltage	≤ 125 VDC \equiv , 125 VAC~ 50/60 Hz			
Rated current	≤ 10 A			
Insulation resistance	≥ 1,000 MΩ (500 VDC \equiv megger)			
Dielectric strength	2,700 VAC~ 50/60 Hz for 1 minute			
Vibration	0.75 mm amplitude at frequency of 10 to 55 Hz (for 1 minute) in each X, Y, Z direction for 2 hours			
Vibration (malfunction)	0.75 mm amplitude at frequency of 10 to 55 Hz (for 1 minute) in each X, Y, Z direction for 10 minutes			
Shock	150 m/s ² (≈ 15 G) in each X, Y, Z direction for 3 times			
Shock (malfunction)	100 m/s ² (≈ 10 G) in each X, Y, Z direction for 3 times			
Ambient temperature	-15 to 55 °C, storage: -25 to 65 °C (no freezing or condensation)			
Ambient humidity	35 to 85 %RH, storage: 35 to 85 %RH (no freezing or condensation)			
Protection structure	IP20 (IEC standard)			
Applicable wire - solid	Ø 0.3 to 1.2 mm			
Applicable wire v- stranded	AWG 22-16 (0.30 to 1.25 mm ²)			
Crimp terminal connection tensile strength	≥ 30 N			
Tightening torque	0.5 to 0.6 N·m			

Screwless

Relay Terminal Blocks

(16-Point)

ABL Series



Features

- Selectable between independent, power common input, and load common output with use of jumper bar
- High tensile force and easy wiring with one-touch screwless type terminal
- Easily check of operation status with operation indicator (blue)
- DIN rail mounting
- Relay protection with the cover
- Easy relay replacement with the relay ejector

Specifications

Model	ABL-H16R6-□
Applied relay ⁰¹⁾	G6B-1174P-FD-US [OMRON]
Output method	1a
Power supply	24 VDC \pm 10 %
Current consumption ⁰²⁾	\leq 20 mA
Rated load voltage & current ^{03) 04)}	250 VAC \sim 3 A, 30 VDC \sim 3 A
No. of connector pin	20
Connector for controller side	20-pin Hirose (HIF3BA-20PA-2.54DSA)
Terminal type	Screwless
Terminal pitch	\geq 7.8 mm
Indicator	Power indicator: red, operation indicator: blue
Varistor	None
Input logic	NPN / PNP model
Material	CASE, BASE: MPPO, terminal block, cover: PC
Approval	CE   
Unit weight (packaged)	\approx 348 g (\approx 446 g)

01) For the detailed information about each relay, please refer to 'Power Relay' or data sheet from the manufacturer.

02) It is current consumption for a relay including LED current.

03) This value is rated with resistive load.

04) When connecting loads to output part, please connect loads of same power type. v
Connecting loads of different power type may cause safety issues.

Insulation resistance	\geq 1,000 M Ω (500 VDC \approx megger)
Dielectric strength (coil-contact)	3,000 VAC \sim 50/60 Hz for 1 minute
Dielectric strength (same polarity contact)	1,000 VAC \sim 50/60 Hz for 1 minute
Vibration	1.5 mm amplitude at frequency 10 to 55 Hz (for 1 min) in each X, Y, Z direction for 2 hours
Vibration (malfunction)	1.5 mm amplitude at frequency 10 to 55 Hz (for 1 min) in each X, Y, Z direction for 10 minutes
Shock	1,000 m/s ² (\approx 100 G) in each X, Y, Z direction for 3 times
Shock (malfunction)	100 m/s ² (\approx 10 G) in each X, Y, Z direction for 3 times
Ambient temperature	-15 to 55 °C, storage: -25 to 65 °C (no freezing or condensation)
Ambient humidity	35 to 85 %RH, storage: 35 to 85 %RH (no freezing or condensation)
Protection structure	IP20 (IEC standard)
Applicable wire - solid ⁰¹⁾	\varnothing 0.6 to 1.25 mm
Applicable wire - stranded ^{01) 02)}	AWG 22-18 (0.30 to 0.80 mm ²)
Stripped length	8 to 10 mm

01) Use the cable of copper conductor in 60 °C temperature class.

02) When using the stranded wire, use End Sleeve (wire ferrule).

Screwless

Relay Terminal Blocks

(4-Point)

ABL Series



Features

- Selectable between independent, NPN (+ COM) / PNP (- COM) input, and load common output with use of jumper bar
- High tensile force and easy wiring with one-touch screwless type terminal
- Easily check of operation status with operation indicator (blue)
- DIN rail mount and screw mount methods
- Relay protection with the cover
- Easy relay replacement with the relay ejector

Specifications

Model	ABL-L04PA-□	ABL-L04TN-□	ABL-L04PQ-□	ABL-L04R6-□
Applied relay ⁰¹⁾	APAN3124 [MATSUSHITA (Panasonic)]	NYP24W-K [TAKAMISAWA (Fujitsu)]	PQ1a-24V [MATSUSHITA (Panasonic)]	G6B-1174P-FD-US [OMRON]
Output method	1a	1a	1a	1a
Power supply	≤ 24 VDC≐ ± 10 %	≤ 24 VDC≐ ± 10 %	≤ 24 VDC≐ ± 10 %	≤ 24 VDC≐ ± 10 %
Current consumption ⁰²⁾	≤ 8 mA	≤ 8 mA	≤ 20 mA	≤ 20 mA
Rated load voltage & current ^{03) 04)}	250 VAC~ 50/60 Hz 3A, 30 VDC≐ 3 A		250 VAC~ 50/60 Hz 3A, 30 VDC≐ 5 A	
Terminal type	Screwless		Screwless	
Terminal pitch	5.0 mm		10.2 mm	
Indicator	Operation indicator: blue		Operation indicator: blue	
Varistor	Equipped ⁰⁵⁾ / not equipped model		Equipped ⁰⁵⁾ / not equipped model	
Input logic	NPN / PNP selectable with jumper bar		NPN / PNP selectable with jumper bar	
Material	Terminal block: PA66, CASE, BASE: PPS, conducting plate: brass		Terminal block: PA66, CASE, BASE: MPPO, conducting plate: brass	
Approval	CE ENEC ENEC		CE ENEC ENEC	
Unit weight (packaged)	≈ 72 g (≈ 125 g)	≈ 75 g (≈ 128 g)	≈ 94 g (≈ 150 g)	≈ 88 g (≈ 144 g)

01) For the detailed information about each relay, please refer to 'Power Relay' or data sheet from the manufacturer.

02) It is current consumption for a relay including LED current.

03) This value is rated with resistive load.

04) When connecting loads to output part, please connect loads of same power type.

Connecting loads of different power type may cause safety issues.

05) Since the varistor type is for protecting the contact, it is recommended to use with an inductive load.

Insulation resistance	≥ 1,000 MΩ (500 VDC≐ megger)
Dielectric strength (coil-contact)	PA, TN, R6: 3,000 VAC~ 50/60 Hz for 1 minute PQ: 4,000 VAC~ 50/60 Hz for 1 minute
Dielectric strength (same polarity contact) ⁰¹⁾	PA, PQ, R6: 1,000 VAC~ 50/60 Hz for 1 minute TN: 750 VAC~ 50/60 Hz for 1 minute
Vibration	PA, TN: 0.75 mm amplitude at frequency of 10 to 55 Hz (for 1 min) in each X, Y, Z direction for 2 hours PQ, R6: 1.5 mm amplitude at frequency of 10 to 55 Hz (for 1 min) in each X, Y, Z direction for 2 hours
Vibration (malfunction)	PA, TN: 0.75 mm amplitude at frequency of 10 to 55 Hz (for 1 min) in each X, Y, Z direction for 10 minutes PQ, R6: 1.5 mm amplitude at frequency of 10 to 55 Hz (for 1 min) in each X, Y, Z direction for 10 minutes
Shock	1,000 m/s ² (≈ 100 G) in each X, Y, Z direction for 3 times
Shock (malfunction)	100 m/s ² (≈ 10 G) in each X, Y, Z direction for 3 times
Ambient temperature	-15 to 55 °C, storage: -25 to 65 °C (a non freezing or condensation environment)
Ambient humidity	35 to 85 %RH, storage: 35 to 85 %RH (a non freezing or condensation environment)
Protection structure	IP20 (IEC standard)
Applicable wire - solid ⁰¹⁾	Ø 0.6 to 1.25 mm
Applicable wire - stranded ^{01) 02)}	AWG 22-18 (0.30 to 0.80 mm ²)
Stripped length	8 to 10 mm

01) Use the cable of copper conductor in 60 °C temperature class.

02) When using the stranded wire, use End Sleeve (wire ferrule).

Screwless

Relay Terminal Blocks

(1-Point)

ABL Series



Features

- Selectable between independent, power common input, and load common output with use of jumper bar
- High tensile force and easy wiring with one-touch screwless type terminal
- Easily check of operation status with operation indicator (blue)
- DIN rail mounting

Specifications

Model	ABL-L01PA-□	ABL-L01TN-□
Applied relay ⁰¹⁾	APAN3124 [MATSUSHITA(Panasonic)]	NYP24W-K [TAKAMISAWA(Fujitsu)]
Output method	1a	
Power supply	≤ 24 VDC≐ ± 10 %	
Current consumption ⁰²⁾	≤ 8 mA	
Rated load voltage & current ^{03) 04)}	250 VAC~ 50/60 Hz 3A, 30 VDC≐ 3A	
Terminal type	Screwless	
Terminal pitch	9.0 mm (arranging over 2 units)	
Indicator	Operation indicator: blue	
Varistor	Equipped / not equipped model	
Input logic	NPN / PNP model	
Material	Terminal block: PA66, CASE, BASE: PPS, conducting plate: brass	
Approval	CE ENEC	
Unit weight (packaged) ⁰⁵⁾	≈ 21 g (≈ 138 g)	≈ 21 g (≈ 135 g)

01) For the detailed information about each relay, please refer to 'Power Relay' or data sheet from the manufacturer.

02) It is current consumption for a relay including LED current.

03) This value is rated with resistive load.

04) When connecting loads to output part, please connect loads of same power type.

Connecting loads of different power type may cause safety issues.

05) It is weight per product. The weight in parentheses is for 4 packing units including packing materials.

Insulation resistance	≥ 1,000 MΩ (500 VDC≐ megger)
Dielectric strength (coil-contact)	3,000 VAC~ 50/60 Hz for 1 minute
Dielectric strength (same polarity contact) ⁰¹⁾	PA: 1,000 VAC~ 50/60 Hz for 1 minute TN: 750 VAC~ 50/60 Hz for 1 minute
Vibration	0.75 mm amplitude at frequency of 10 to 55 Hz (for 1 min) in each X, Y, Z direction for 2 hours
Vibration (malfunction)	0.75 mm amplitude at frequency of 10 to 55 Hz (for 1 min) in each X, Y, Z direction for 10 minutes
Shock	1,000 m/s ² (≈ 100 G) in each X, Y, Z direction for 3 times
Shock (malfunction)	100 m/s ² (≈ 10 G) in each X, Y, Z direction for 3 times
Ambient temperature	-15 to 55 °C, storage: -25 to 65 °C (no freezing or condensation)
Ambient humidity	35 to 85 %RH, storage: 35 to 85 %RH (no freezing or condensation)
Protection structure	IP20 (IEC standard)
Applicable wire - solid ⁰¹⁾	∅ 0.6 to 1.25 mm
Applicable wire - stranded ^{01) 02)}	AWG 22-18 (0.30 to 0.80 mm ²)
Stripped length	8 to 10 mm

01) Use the cable of copper conductor in 60 °C temperature class.

02) When using the stranded wire, use End Sleeve (wire ferrule).

Relay Terminal Blocks

(4 / 16 / 32-Point)

ABS Series



Features

- Suitable for operating various loads using output signal of PLC
- Easily check of operation status with high luminance LED which turns on with input signals
- Available to select from various kinds of relay according to the voltage and current of each load
- DIN rail mount and screw mount methods

Specifications

Model	ABS-S04□-CN	ABS-H16□-□	ABS-H32□-□
Applied relay ⁰¹⁾	PA: APAN3124 [MATSUSHITA (Panasonic)] / TN: NYP24W-K	[TAKAMISAWA (Fujitsu)]	
Output method	1a	1a	1a
Power supply	≤ 24 VDC± ±10 %	≤ 24 VDC± ±10 %	≤ 24 VDC± ±10 %
Current consumption	PA: ≤ 8 mA ⁰²⁾ TN: ≤ 8.5 mA ⁰²⁾	PA: ≤ 8 mA ⁰²⁾ or ≤ 13 mA ⁰³⁾ TN: ≤ 8.5 mA ⁰²⁾ or ≤ 13.5 mA ⁰³⁾	
Rated load voltage & current ⁰⁴⁾ ⁰⁵⁾	250 VAC~ 3A, 30 VDC± 3A	250 VAC~ 3A, 30 VDC± 3A	250 VAC~ 2A, 30 VDC± 2A
No. of connector pins	-	20	40
Connector for controller side	-	20-pin Hirose (HIF3BA-20PA-2.54DSA)	40-pin Hirose (HIF3BA-40PA-2.54DSA)
No. of relay points	4	16	32 (8점/1COM)
Terminal type	Screw	Screw	Screw
Terminal pitch	7.62 mm	7.62 mm	7.62 mm
Indicator	Operation indicator: blue	Power indicator: red, operating and disconnection indicator: blue	Power indicator: red, operating and disconnection indicator: blue
Varistor	None	None	None
Input logic	-	NPN / PNP model	NPN / PNP model
Material	CASE, BASE: MPPO, terminal pin: brass	CASE: MPPO, BASE: PA66 (G25%), terminal pin: brass	CASE: MPPO, BASE: PA66 (G25%), terminal pin: brass
Approval	CE ⁰⁶⁾	CE ⁰⁶⁾	CE ⁰⁶⁾
Unit weight (packaged)	PA: ≈ 68 g (≈ 104 g) TN: ≈ 71 g (≈ 107 g)	PA: ≈ 224 g (≈ 307 g) TN: ≈ 235 g (≈ 318 g)	PA: ≈ 345 g (≈ 438 g) TN: ≈ 370 g (≈ 463 g)

01) For the detailed information about each relay, please refer to 'Power Relay' or data sheet from the manufacturer.

02) It is current consumption for a relay including LED current.

03) It is current consumption including LED current for power part to 2).

04) This value is rated with resistive load.

05) When connecting loads to output part, please connect loads of same power type.

Connecting loads of different power type may cause safety issues.

06) 30 VDC± of rated load voltage is not subjected to UL Listed.

Insulation resistance	≥ 1,000 MΩ (500 VDC± megger)
Dielectric strength (coil-contact)	3,000 VAC~ 50/60 Hz for 1 minute
Dielectric strength (same polarity contact)	PA: 1,000 VAC~ 50/60 Hz for 1 minute TN: 750 VAC~ 50/60 Hz for 1 minute
Vibration	0.75mm amplitude at frequency of 10 to 55Hz (for 1 min) in each X, Y, Z direction for 2 hours
Vibration (malfunction)	0.75mm amplitude at frequency of 10 to 55Hz (for 1 min) in each X, Y, Z direction for 10 min
Shock	500 m/s ² (≈ 50 G) in each X, Y, Z direction for 3 times
Shock (malfunction)	147 m/s ² (≈ 15 G) in each X, Y, Z direction for 3 times
Ambient temperature	-15 to 55 °C, storage: -25 to 65 °C (no freezing or condensation)
Ambient humidity	35 to 85 %RH, storage: 35 to 85 %RH (no freezing or condensation)
Applicable wire - stranded	AWG 22-16 (0.30 to 1.25 mm ²)
Tightening torque	0.5 to 0.6 N·m

Relay Terminal Blocks

(1-Point)

ABS Series

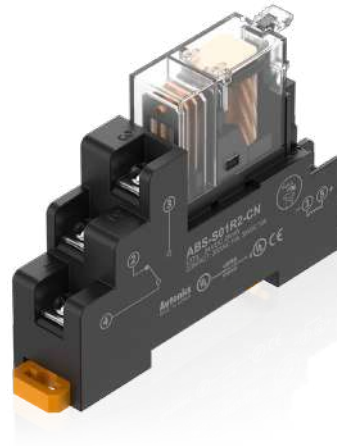

Features

- Suitable for operating various loads using output signal of PLC
- Easily check of operation status with high luminance LED which turns on with input signals
- Available to select from various kinds of relay according to the voltage and current of each load
- Easy replacement of relay with the relay releasing lever
- DIN rail mount and screw mount methods
- Tight installation and free expansion possible with interlocking design

Specifications

Model	3 A model	5 A model	10 A model		
	ABS-S01□-CN	ABS-S01□-CN	ABS-S01R2-CN	ABS-S01R26-CN	ABS-S01R25-CN
Applied relay ⁰¹⁾	PA: APAN3124 [MATSUSHITA (Panasonic)] TN: NYP24W-K [TAKAMISAWA (Fujitsu)]	PQ: PQ1a-24V [MAT-SUSHITA (Panasonic)] R6: G6B-1174P-FD-US [OMRON]	G2R-1-S24VDC [OMRON]	G2R-1-S100/ (110)VAC [OMRON]	G2R-1-S200/ (220)VAC [OMRON]
Output method	1a	1a	1c	1c	1c
Power supply	≤ 24 VDC ≒ ±10 %	≤ 24 VDC ≒ ±10 %	≤ 24 VDC ≒ ±10 %	100/110 VAC ~	200/220 VAC ~
Current consumption	PA: ≤ 8 mA TN: ≤ 8.5 mA	≤ 20 mA	≤ 25 mA	≤ 15 mA	≤ 10 mA
Rated load voltage & current ^{02) 03)}	250 VAC ~ 3A, 30 VDC ≒ 3A	250 VAC ~ 5A, 30 VDC ≒ 5A	250 VAC ~ 5A, 30 VDC ≒ 5A	250 VAC ~ 5A, 30 VDC ≒ 5A	250 VAC ~ 5A, 30 VDC ≒ 5A
Terminal type	Screw	Screw	Screw	Screw	Screw
Indicator	Operation indicator: blue	Operation indicator: blue	Operation indicator: blue	Operation indicator: blue	Operation indicator: blue
Varistor	None	None	None	None	None
Material	CASE, BASE: PA6, terminal pin: brass	CASE, BASE: PA6, terminal pin: brass	CASE, BASE: PBT, terminal pin: brass, phosphor bronze	CASE, BASE: PBT, terminal pin: brass, phosphor bronze	CASE, BASE: PBT, terminal pin: brass, phosphor bronze
Approval	CE, ENEC, ERM ⁰⁴⁾	CE, ENEC, ERM ⁰⁴⁾	CE, ENEC, ERM ⁰⁴⁾	CE, ENEC, ERM ⁰⁴⁾	CE, ENEC, ERM ⁰⁴⁾
Unit weight (packaged) ⁰⁵⁾	PA: ≈ 21.5 g (≈ 314.5 g) TN: ≈ 22.2 g (≈ 324.5 g)	PQ: ≈ 31 g (≈ 430 g) R6: ≈ 30 g (≈ 416 g)	≈ 53 g (≈ 719 g)	≈ 52 g (≈ 711 g)	≈ 52 g (≈ 712 g)

01) For the detailed information about each relay, please refer to 'Power Relay' or data sheet from the manufacturer.

02) This value is rated with resistive load.

03) When connecting loads to output part, please connect loads of same power type.

Connecting loads of different power type may cause safety issues.

04) 30 VDC ≒ of rated load voltage is not subjected to UL Listed.

05) It is weight per product. The weight in parentheses is for 10 packing units (PA, TN: 14) including packing materials.

Insulation resistance	≥ 1,000 MΩ (500 VDC ≒ megger)
Dielectric strength (coil-contact)	PA, TN: 3,000 VAC ~ 50/60 Hz for 1 minute PQ, R6: 4,000 VAC ~ 50/60 Hz for 1 minute R2 (5, 6): 5,000 VAC ~ 50/60 Hz for 1 minute
Dielectric strength (same polarity contact)	PA: 1,000 VAC ~ 50/60 Hz for 1 minute, TN: 750 VAC ~ 50/60 Hz for 1 minute PQ: 1,000 VAC ~ 50/60 Hz for 1 minute, R6: 3,000 VAC ~ 50/60 Hz for 1 minute R2 (5, 6): 1,000 VAC ~ 50/60 Hz for 1 minute
Vibration	0.75 mm amplitude at frequency of 10 to 55 Hz (for 1 min) in each X, Y, Z direction for 2 hours
Vibration (malfunction)	0.75 mm amplitude at frequency of 10 to 55 Hz (for 1 min) in each X, Y, Z direction for 10 min
Shock	PA, TN: 500 m/s ² (≈ 50 G) in each X, Y, Z direction for 3 times PQ, R6, R2 (5, 6): 1,000 m/s ² (≈ 100 G) in each X, Y, Z direction for 3 times
Shock (malfunction)	PA, TN: 147 m/s ² (≈ 15 G) in each X, Y, Z direction for 3 times PQ, R6, R2 (5, 6): 100 m/s ² (≈ 10 G) in each X, Y, Z direction for 3 times
Ambient temperature	-15 to 55 °C, storage: -25 to 65 °C (no freezing or condensation)
Ambient humidity	35 to 85 %RH, storage: 35 to 85 %RH (no freezing or condensation)
Applicable wire - stranded	PA, TN: AWG 22-16 (0.30 to 1.25 mm ²) PQ, R6: AWG 19-14 (0.65 to 2.0 mm ²) R2 (5, 6): AWG 17-14 (1.0 to 2.0 mm ²)
Tightening torque	PA, TN: 0.5 to 0.6 N·m PQ, R6: 0.7 to 0.8 N·m R2 (5, 6): 0.7 to 0.8 N·m

Screwless SSR Terminal Blocks (16-Point)

ASL Series



Features

- Selectable between independent and load common output with use of jumper bar
- High tensile force and easy wiring with one-touch screwless type terminal
- Easily check of operation status with operation indicator (blue)
- DIN rail mounting
- SSR protection with the cover
- Easy SSR replacement with the SSR ejector

Specifications

Model	ASL-H16MPO-□N
Applied SSR ⁰¹⁾	AQZ202D [Panasonic]
Output method	1a
Power supply	≤ 24 VDC ± 10 %
Current consumption ⁰²⁾	≤ 4 mA
Rated load specification ^{03) 04)}	24 VAC~ / VDC ± 50/60 Hz
No. of connector pin	20
Connector for controller side	20-pin Omron (XG4A-2031)
Terminal type	Screwless
Terminal pitch	≥ 7.8 mm
Indicator	Power indicator: red, operation indicator: blue
Varistor	None
Input logic	NPN / PNP model
Material	Terminal block: PC, CASE, BASE: MPPO
Approval	CE 
Unit weight (packaged)	≈ 278 g (≈ 377 g)
Insulation resistance	≥ 1,000 MΩ (500 VDC ± megger)
Dielectric strength (coil-contact)	2,500 VAC~ 50/60 Hz for 1 minute
Dielectric strength (same polarity contact)	1,000 VAC~ 50/60 Hz for 1 minute
Vibration	0.75 mm amplitude at frequency of 10 to 55 Hz (for 1 min) in each X, Y, Z direction for 2 hours
Vibration (malfunction)	0.75 mm amplitude at frequency of 10 to 55 Hz (for 1 min) in each X, Y, Z direction for 10 minutes
Shock	1,000 m/s ² (≈ 100 G) in each X, Y, Z direction for 3 times
Shock (malfunction)	100 m/s ² (≈ 10 G) in each X, Y, Z direction for 3 times
Ambient temperature	-15 to 55 °C, storage: -25 to 65 °C (no freezing or condensation)
Ambient humidity	35 to 85 %RH, storage: 35 to 85 %RH (no freezing or condensation)
Protection structure	IP20 (IEC standard)
Applicable wire - solid ⁰¹⁾	Ø 0.6 to 1.25 mm
Applicable wire - stranded ^{01) 02)}	AWG 22-18 (0.30 to 0.80 mm ²)
Stripped length	8 to 10 mm

01) For the detailed information about each SSR, please refer to 'SSR' or data sheet from the manufacturer.

02) It is current consumption for a SSR including LED current.

03) This value is rated when using the resistive load. Use proper current for the ambient temperature. (Refer to the 'Temperature Characteristic Graph'.)

04) When connecting loads to output part, please connect loads of same power type. Connecting loads of different power type may cause safety issues.

01) Use the cable of copper conductor in 60 °C temperature class.

02) When using the stranded wire, use End Sleeve (wire ferrule).

Screwless

SSR Terminal Blocks

(4-Point)

ASL Series



Features

- Selectable between independent, NPN (+ COM) / PNP (- COM) input, and load common output with use of jumper bar
- High tensile force and easy wiring with one-touch screwless type terminal
- Easily check of operation status with operation indicator (blue)
- DIN rail mount and screw mount methods
- SSR protection with the cover
- Easy SSR replacement with the SSR ejector

Specifications

Model	ASL-L04MPO-U□	ASL-L04SPO-U□	ASL-L04STO-U□
Applied SSR ⁰¹⁾	AQZ202D [Panasonic]	AQG12124 [Panasonic]	SN-24A01C [Fujitsu]
Output method	1a	1a	1a
Power supply	≤ 24 VDC≒ ±10 %	≤ 24 VDC≒ ±10 %	≤ 24 VDC≒ ±10 %
Current consumption ⁰²⁾	≤ 3 mA	≤ 18 mA	≤ 10 mA
Rated load voltage & current ^{03) 04)}	60 VAC~ 50/60 Hz 2.7 A, 60 VDC≒ 2.7A	75-240 VAC~ 1 A 50/60 Hz	24-240 VAC~ 1 A 50/60 Hz
Terminal type	Screwless		
Terminal pitch	5.0 mm		
Indicator	Operation indicator: blue		
Varistor	Equipped ⁰⁵⁾ / not equipped model		
Input logic	NPN / PNP selectable with jumper bar		
Material	Terminal block: PA66, CASE, BASE: PPS, conducting plate: brass		
Approval	CE ENEC	CE ENEC	CE ENEC
Unit weight (packaged)	≈ 65 g (≈ 118 g)	≈ 69 g (≈ 122 g)	≈ 172 g (≈ 126 g)

01) For the detailed information about each SSR, please refer to 'SSR' or data sheet from the manufacturer.

02) It is current consumption for a SSR including LED current.

03) This value is rated with resistive load, when the conditions of the temperature characteristic graph are satisfied.

04) When connecting loads to output part, please connect loads of same power type. Connecting loads of different power type may cause safety issues.

05) Since the varistor type is for protecting the contact, it is recommended to use with an inductive load.

Insulation resistance	≥ 1,000 MΩ (500 VDC≒ megger)
Dielectric strength (coil-contact)	2,500 VAC~ 50/60 Hz for 1 minute
Dielectric strength (same polarity contact) ⁰¹⁾	1,000 VAC~ 50/60 Hz for 1 minute
Vibration	0.75 mm amplitude at frequency of 10 to 55 Hz (for 1 min) in each X, Y, Z direction for 2 hours
Vibration (malfunction)	0.75 mm amplitude at frequency of 10 to 55 Hz (for 1 min) in each X, Y, Z direction for 10 minutes
Shock	1,000 m/s ² (≈ 100 G) in each X, Y, Z direction for 3 times
Shock (malfunction)	100 m/s ² (≈ 10 G) in each X, Y, Z direction for 3 times
Ambient temperature	-15 to 55 °C, storage: -25 to 65 °C (no freezing or condensation)
Ambient humidity	35 to 85 %RH, storage: 35 to 85 %RH (no freezing or condensation)
Protection structure	IP20 (IEC standard)

01) Varistor type is 300 VAC~.

Applicable wire - solid ⁰¹⁾	Ø 0.6 to 1.25 mm
Applicable wire - stranded ^{01) 02)}	AWG 22-18 (0.30 to 0.80 mm ²)
Stripped length	8 to 10 mm

01) Use the cable of copper conductor in 60 °C temperature class.

02) When using the stranded wire, use End Sleeve (wire ferrule).

Screwless SSR Terminal Blocks (1-Point)

ASL Series



Features

- Selectable between independent, power common input, and load common output with use of jumper bar
- High tensile force and easy wiring with one-touch screwless type terminal
- Easily check of operation status with operation indicator (blue)
- DIN rail mounting

Specifications

Model	ASL-L01MP0-□	ASL-L01SP0-□	ASL-L01SP1-□	ASL-L01SR0-□	ASL-L01ST0-□
Applied SSR ⁰¹⁾	AQZ202D [Panasonic]	AQG12124 [Panasonic]	AQG22124 [Panasonic]	G3MC-202P [Omron]	SN-24A01C [Fujitsu]
Output method	1a	1a	1a	1a	1a
Power supply	≤ 24 VDC≐ ±10 %	≤ 24 VDC≐ ±10 %	≤ 24 VDC≐ ±10 %	≤ 24 VDC≐ ±10 %	≤ 24 VDC≐ ±10 %
Current consumption ⁰²⁾	≤ 3 mA	≤ 18 mA	≤ 18 mA	≤ 18 mA	≤ 10 mA
Rated load voltage & current ⁰³⁾⁰⁴⁾	60 VAC~ 50/60 Hz, 2.7 A 60 VDC≐ 2.7A	75-240 VAC~ 50/60 Hz 1 A	75-240 VAC~ 50/60 Hz 2 A	24-240 VAC~ 50/60 Hz 2 A	24-240 VAC~ 50/60 Hz 1 A
Terminal type	Screwless				
Terminal pitch	9.0 mm (arranging over 2 units)				
Indicator	Operation indicator: blue				
Varistor	Equipped / not equipped model				
Input logic	NPN / PNP model				
Material	Terminal block: PA66, CASE, BASE: PPS, conducting plate: brass				
Approval	CE, ENEC, EAC	CE, ENEC, EAC	CE, ENEC, EAC	CE, ENEC, EAC	CE, EAC
Unit weight (packaged) ⁰⁵⁾	≈ 19 g (≈ 130 g)	≈ 20 g (≈ 134 g)	≈ 22 g (≈ 140 g)	≈ 24 g (≈ 148 g)	≈ 21 g (≈ 136 g)

01) For the detailed information about each SSR, please refer to 'SSR' or data sheet from the manufacturer.

02) It is current consumption for a SSR including LED current.

03) This value is rated with resistive load, when the conditions of the temperature characteristic graph are satisfied.

04) When connecting loads to output part, please connect loads of same power type.

Connecting loads of different power type may cause safety issues.

05) It is weight per product. The weight in parentheses is for 4 packing units including packing materials.

Insulation resistance	≥ 1,000 MΩ (500 VDC≐ megger)
Dielectric strength (coil-contact)	2,500 VAC~ 50/60 Hz for 1 minute
Dielectric strength (same polarity contact) ⁰¹⁾	1,000 VAC~ 50/60 Hz for 1 minute
Vibration	0.75 mm amplitude at frequency of 10 to 55 Hz (for 1 min) in each X, Y, Z direction for 2 hours
Vibration (malfunction)	0.75 mm amplitude at frequency of 10 to 55 Hz (for 1 min) in each X, Y, Z direction for 10 minutes
Shock	1,000 m/s ² (≈ 100 G) in each X, Y, Z direction for 3 times
Shock (malfunction)	100 m/s ² (≈ 10 G) in each X, Y, Z direction for 3 times
Ambient temperature	-15 to 55 °C, storage: -25 to 65 °C (no freezing or condensation)
Ambient humidity	35 to 85 %RH, storage: 35 to 85 %RH (no freezing or condensation)
Protection structure	IP20 (IEC standard)

01) Varistor type is 300 VAC~.

Applicable wire - solid ⁰¹⁾	Ø 0.6 to 1.25 mm
Applicable wire - stranded ⁰¹⁾⁰²⁾	AWG 22-18 (0.30 to 0.80 mm ²)
Stripped length	8 to 10 mm

01) Use the cable of copper conductor in 60 °C temperature class.

02) When using the stranded wire, use End Sleeve (wire ferrule).

Sensor Connector Terminal Blocks

AFE Series



Features

- Quicker and easier wiring with sensor connectors
- Wire stripping and other tools not required
- Compact and space-saving design
- Available to check operation status and cable connection easily with LED light
- DIN rail mount and screw mount methods
- Selectable between NPN and PNP input with NPN / PNP selection switch

Specifications

Model	AFE4-H20-16LF	AFE4-H40-32LF
The number of connector pin	20	40
The number of sensor connector	16	32
Connector for controller side	20-pin Hirose (HIF3BA-20PA-2.54DSA)	40-pin Hirose (HIF3BA-40PA-2.54DSA)
Indicator	Power indicator: red, operation and disconnection indicator: blue	
Material	CASE, BASE: PC	
Approval	CE cULus ENEC	
Unit weight (Packaged)	≈ 69 g (≈ 121 g)	≈ 119 g (≈ 203 g)
Voltage	12-24 VDC± ±10%	
Current	≤ 1 A ⁰¹⁾	
Insulation resistance	≥ 1,000 MΩ (500 VDC± megger)	
Input logic	NPN/PNP switch	
Dielectric strength	600 VAC~ 50/60 Hz for 1 minute	
Vibration	0.75 mm amplitude at frequency of 10 to 55 Hz (for 1 minute) in each X, Y, Z direction for 1 hour	
Vibration (malfunction)	0.75 mm amplitude at frequency of 10 to 55 Hz (for 1 minute) in each X, Y, Z direction for 10 minutes	
Shock	150 m/s ² (≈ 15 G) in each X, Y, Z direction for 3 times	
Shock (malfunction)	100 m/s ² (≈ 10 G) in each X, Y, Z direction for 3 times	
Ambient temperature	-15 to 55 °C, storage: -25 to 65 °C (no freezing or condensation)	
Ambient humidity	35 to 85 %RH, storage: 35 to 85 %RH (no freezing or condensation)	
<small>01) It includes LED current of terminal block.</small>		
Tightening torque	0.7 to 0.8 N·m	



I2. Distribution Boxes

Distribution boxes can simplify sensor connection work and provide installation flexibility in applications requiring multiple sensors.

I2-1 Distribution Boxes

PT Series

M12 5-Pin Connector Distribution Boxes

M12 4-Pin Connector Distribution Boxes

M12 5-Pin Connector Distribution Boxes

PT Series



Features

- 5-pin M12 connector types (cable / connector / spring terminal / plug-in terminal)
- Easy check operation by operation indicator (red / green)
- Single power operates several sensors
- Convenient wiring and power line
- IP67 protection structure with water-proof cover (IP52 protection structure with protection cover)
- Supports 1-signal, 2-signal (DC 4-wire)

Specifications

[Cable type]

Model	PT4-3D□5-□	PT4-4D□5-□	PT6-3D□5-□	PT6-4D□5-□	PT8-3D□5-□	PT8-4D□5-□
No. of port	4	4	6	6	8	8
Output type ⁰¹⁾	3-wire (1 signal)	4-wire (2 signal)	3-wire (1 signal)	4-wire (2 signal)	3-wire (1 signal)	4-wire (2 signal)
Output logic ⁰¹⁾	NPN/PNP model					
Material	Case: PBT (G15 %), name plate: PC, general cable (black): PVC					
Approval	CE ENEC					
Unit weight (packaged) ⁰²⁾	≈ 900 g (≈ 1100 g)	≈ 1200 g (≈ 1400 g)	≈ 930 g (≈ 1130 g)	≈ 1230 g (≈ 1430 g)	≈ 960 g (≈ 1160 g)	≈ 1260 g (≈ 1460 g)

01) Connect the sensor to the proper output type and logic.

02) It is based on 5 m cable.

[Connector type]

Model	PT4-C3D□5	PT4-C4D□5	PT6-C3D□5	PT6-C4D□5	PT8-C3D□5	PT8-C4D□5
No. of port	4	4	6	6	8	8
Output type ⁰¹⁾	3-wire (1 signal)	4-wire (2 signal)	3-wire (1 signal)	4-wire (2 signal)	3-wire (1 signal)	4-wire (2 signal)
Output logic ⁰¹⁾	NPN/PNP model					
Material	Case: PBT (G15 %), name plate: PC, general cable (black): PVC					
Approval	CE ENEC					
Unit weight (packaged)	≈ 120 g (≈ 230 g)	≈ 125 g (≈ 235 g)	≈ 150 g (≈ 260 g)	≈ 155 g (≈ 265 g)	≈ 180 g (≈ 290 g)	≈ 185 g (≈ 295 g)

01) Connect the sensor to the proper output type and logic.

[Spring terminal type]

Model	PT4-S3D □	PT6-S3D □	PT8-S3D □
No. of port	4	6	8
Output type ⁰¹⁾	3-wire (1 signal)		
Output logic ⁰¹⁾	NPN / PNP model		
Material	Case: PBT (G15 %), name plate: PC, cover: PBT (G15 %), cover bolt: PA6 (G15 %)		
Applicable cable out diameter	10.5 mm ± 0.3		
Approval	CE ENEC		
Unit weight (packaged)	≈ 140 g (≈ 270 g)	≈ 165 g (≈ 292 g)	≈ 190 g (≈ 314 g)

01) Connect the sensor to the proper output type and logic.

[Pluggable screw terminal type]

Model	PT4-P3D □-□	PT6-P3D □-□	PT8-P3D □-□
No. of port	4	6	8
Output type ⁰¹⁾	3-wire (1 signal)		
Output logic ⁰¹⁾	NPN / PNP model		
Material	Case: PBT (G15 %), name plate: PC, cover: PBT (G15 %), cover bolt: PA6 (G15 %)		
Applicable cable out diameter	10.5 mm ± 0.3		
Approval	CE ENEC		
Unit weight (packaged)	≈ 150 g (≈ 280 g)	≈ 175 g (≈ 302 g)	≈ 210 g (≈ 334 g)
01) Connect the sensor to the proper output type and logic.			
Power supply	12-24 VDC≡		
Rated current	· Cable type / connector type: 2 A (per signal), 4 A (per port), 10 A (body) · Spring / pluggable screw terminal type: 2 A (per signal), 2 A (per port), 7 A (body)		
Leakage current	≤ 0.5 mA (only applicable for the cable type / connector type)		
Current consumption	≤ 5 mA		
Connection life cycle	≥ 200 operations		
Insulation resistance	≥ 100 MΩ (500 VDC≡ megger)		
Dielectric strength	500 VAC~ 50/60 Hz for 1 minute		
Vibration	3 mm amplitude at frequency of 10 to 55Hz (for 1 min) in each X, Y, Z direction for 2 hours		
Shock	500 m/s ² (≈ 50 G) X, Y, Z in each X, Y, Z direction for 3 times		
Indicator	Power indicator: red / operation indicator: green		
Ambient temperature	-25 to 75 °C, storage: -30 to 80 °C (a non freezing or condensation environment)		
Ambient humidity	35 to 95 %RH, storage: 35 to 95 %RH (a non freezing or condensation environment)		
Protection structure ⁰¹⁾	With connector / waterproof cover: IP67 (IEC standard) With protection cover: IP52 (IEC standard)		

01) This is not applicable when connectors and protection/waterproof covers are not mounted.

M12 4-Pin Connector Distribution Boxes

PT Series



Features

- 4-pin M12 connector type sensor distribution boxes (cable type)
- Easy check operation by operation indicator (red / green)
- Single power operates several sensors
- Convenient wiring and power line
- IP67 protection structure with water-proof cover (IP52 protection structure with protection cover)
- Supports 1-signal, 2-signal (DC 4-wire)

Specifications

Model	PT4-2D	PT4-3D□	PT6-2D	PT6-3D□	PT8-2D	PT8-3D□
No. of port	4	4	6	6	8	8
Output type ⁰¹⁾	2-wire (1 signal)	3-wire (1 signal)	2-wire (1 signal)	3-wire (1 signal)	2-wire (1 signal)	3-wire (1 signal)
Output logic ⁰¹⁾	-	NPN/PNP model	-	NPN/PNP model	-	NPN/PNP model
Material	Case: PC, general cable (gray): PVC					
Approval	CE ENEC					
Unit weight (packaged) ⁰²⁾	≈ 660 g (≈ 700 g)		≈ 680 g (≈ 720 g)		≈ 780 g (≈ 820 g)	

01) Connect the sensor to the proper output type and logic.

02) It is based on 5 m cable.

Power supply	12-24 VDC≐
Using power supply	10-30 VDC≐
Rated current	2 A (per signal), 4 A (per port), 10 A (body)
Leakage current	≤ 0.5 mA
Connection life cycle	≥ 200 operations
Insulation resistance	≥ 50 MΩ (500 VDC≐ megger)
Dielectric strength	1500 VAC~ 50/60 Hz for 1 minute
Vibration	10 mm amplitude at frequency of 10 to 55Hz (for 1 min) in each X, Y, Z direction for 2 hours
Shock	500 m/s ² (≈ 50 G) X, Y, Z in each X, Y, Z direction for 3 times
Indicator	Power indicator: green / operation indicator: red
Cable specification	∅ 9, 8-wire (conductor cross section: 0.3 mm ² , insulator diameter: ∅ 1.67)
Ambient temperature	-25 to 75 °C, storage: -30 to 80 °C (a non freezing or condensation environment)
Ambient humidity	35 to 95 %RH, storage: 35 to 95 %RH (a non freezing or condensation environment)
Protection structure ⁰¹⁾	With connector / waterproof cover: IP67 (IEC standard) With protection cover: IP52 (IEC standard)

01) This is not applicable when connectors and protection/waterproof covers are not mounted.



13. Sockets

Sockets are used with Autonics plug-in type devices and offer easier installation along with high durability and electrical conductivity.

I3-1	Sockets	PG Series	8-Pin / 11-Pin Controller Sockets
		PS Series	8-Pin / 11-Pin Controller Sockets (DIN Rail / Panel)

8-Pin / 11-Pin Controller Sockets

PG Series

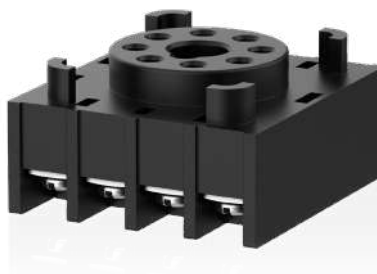

Features

- Excellent heat resistance
- Copper alloy contacts for excellent electrical conductivity and high durability
- Isolated contacts

Specifications

Model	PG-08	PG-11
Pins	8-pin	11-pin
Rated voltage	250 VAC~	
Rated current	7 A (resistance load)	
Insulation resistance	≥ 100 MΩ (500 VDC≡ megger)	
Dielectric strength	2000 VAC~ 50 / 60 Hz for 1 min	
Vibration	0.75 mm amplitude at frequency of 10 to 55 Hz (for 1 min) in each X, Y, Z direction for 1 hour	
Shock	980 m/s ² (≈ 98 G) in each X, Y, Z direction for 3 times	
Ambient temperature	-10 to 55 °C, storage: -25 to 65 °C (no freezing or condensation)	
Ambient humidity	35 to 85 %RH (no freezing or condensation)	
Tightening torque	0.8 N.m	
Applied screw	M3.5	
Material	BODY: PBT, BOLT: Steel (Ni plated), NUT: Steel (Ni plated), terminal: Phosphor bronze(Ni plated)	
Approval		
Unit weight	≈ 37.5 g	≈ 47 g

8-Pin / 11-Pin Controller

Sockets

(DIN Rail / Panel)

PS Series



Features

- Excellent heat resistance
- Copper alloy contacts for excellent electrical conductivity and high durability
- Easy one-touch mount installation

Specifications

Model	PS-08(N)	PS-11(N)	PS-M8 ⁰¹⁾
Pins	8-pin	11-pin	8-pin
Rated voltage	250 VAC~		
Rated current	7 A (resistance load)		
Insulation resistance	≥ 100 MΩ (500 VDC≡ megger)		
Dielectric strength	2000 VAC~ 50 / 60 Hz for 1 min		
Vibration	0.75 mm amplitude at frequency of 10 to 55 Hz (for 1 min) in each X, Y, Z direction for 1 hour		
Shock	980 m/s ² (≈ 98 G) in each X, Y, Z direction for 3 times		300 m/s ² (≈ 30 G) in each X, Y, Z direction for 3 times
Ambient temperature	-10 to 55 °C, storage: -25 to 65 °C (no freezing or condensation)		
Ambient humidity	35 to 85%RH (no freezing or condensation)		
Tightening torque	0.8 N m		0.75 to 0.95 N m
Applied screw	M4		
Material	BODY: PBT, BOLT: Steel (Ni plated), NUT: Steel (Ni plated), terminal: Phosphor bronze(Ni plated)		
Approval			
Unit weight	≈ 62 g	≈ 85 g	≈ 43 g

01) Only for timer ATS Series



14. Connectors

Sensor connectors provide convenient installation and maintenance in addition to strong and stable connections.

Sensor Connectors

CNE Series



Features

[Common Features]

- Significantly reduce installation work and time
- Wide range of connectors compatible with diverse cables and wires
- High density connection with contact pitch of 2 mm
- Compatible with e-CON connectors
- 3 A current capacity for each pin

[Wire Mount Plug / Socket]

- Compact and secure one-touch connection type sensor connectors
- Wire mount plug / sockets allow relay connection of wires
- 9 different color covers for identifying wire thickness
- Visually inspect connection status with translucent covers

[Board Mount Socket]

- Contacts positioned within mold to prevent electric shock or short-circuit
- Connect up to 4 wire mount plugs (1 / 2 / 4)
- Closely-packed connection possible

Specifications

Type	Wire mount plug	Wire mount Socket	Board mount socket
Model	CNE-P	CNE-S	CNE-B
Application	Connector	Board mount socket / Wire mount Socket	Wire mount plug
	Cable	AWG30 - 20 (insulator outside diameter Ø 0.6 to 2.0)	
	PCB	-	Fender plated-through hole, hole dia.: 1.0 mm PCB thickness: 1.0 to 2.2 mm
Power supply	≤ 32 VAC~ / VDC=		
Rated current	≤ 3.0 A		
Ambient temperature	Applying 1 A: -20 to 85 °C Applying 2 A: -20 to 75 °C Applying 3 A: -20 to 60 °C (rated at no freezing or condensation)		
Ambient humidity	40 to 80%RH (rated at no freezing or condensation)		
Terminal retention	≥ 1.4 kgf		
Pressure strength	AWG30: ≥ 0.5 kgf AWG24: ≥ 0.8 kgf AWG20: ≥ 1.0 kgf		
Extraction	≥ 0.49N (50 gf) / pin		
Insertion	≤ 1.96 N (200 gf) / pin		
Dielectric strength	1,000 VAC~ for 1 min (between terminals)		
Insulation resistance	≥ 1,000 MΩ (between terminals)		
Contact resistance	≤ 0.05 Ω (short current: 1 mA, max. open voltage: 20 mV)		
Material	Body: PC/ABS (UL94V-0), terminal: C5210 (Gold 0.2μm), case: PC (UL94-V0)		Body: PC/ABS (UL94-V0), terminal: C5210 (Gold 0.2μm)



15. Cables

I/O cables allow reliable signal transmission between devices including various PLCs, servo, and controllers.

I5-1	Connector Cables	M8 / M12 Series	Connector Cables
		M17 Series	Connector Cables
		M23 Series	Connector Cables
I5-2	I/O Cables	CH Series	I/O Cables
		CO Series	I/O Cables
I5-3	Communication Cables	D-SUB Series	D-SUB Connector Communication Cables
		M12 Series	M12 Connector Communication Cables
I5-4	Valve Plug Cables	CV Series	Valve Plug Cables

Connector Cables

M8 / M12 Series



Features

- M8 Connector type 4-pin models available
- M12 Connector type 4-pin / 5-pin / 8-pin / 12-pin models available
- Various cable length
- Available in I-type connector, L-type connector, cable type
- Autonics application
 - M8 4-pin: Photoelectric Sensors
 - M12 4-pin: Photoelectric / Proximity Sensors, Safety Door Switches, Area Sensors
 - M12 5-pin: Safety Non-Contact Door Switches
 - M12 8-pin: Smart Camera, Safety Light Curtain
 - M12 12-pin: Vision Sensor

Specifications

M8 Connector 4-Pin

Power	Connector 1	Connector 2	Length	Feature	Application	Model
DC	M8 (Socket-Female)	4-wire	2 m	PVC	Photoelectric sensors / Proximity sensors	CID408-2
			5 m			CID408-5
			2 m	Oil resistant PVC		CIDH408-2
			5 m			CIDH408-5
	M8 (Socket-Female), L type		2 m	PVC	CLD408-2	
			5 m		CLD408-5	
			2 m	Oil resistant PVC	CLDH408-2	
			5 m		CLDH408-5	

M12 Connector 4-Pin

Power	Connector 1	Connector 2	Length	Feature	Application	Model		
AC	M12 (Socket-Female)	2-wire	2 m	PVC	Photoelectric sensors / Proximity sensors / Safety door switches	CIA2-2		
			5 m			CIA2-5		
			2 m	Oil resistant PVC		CIAH2-2		
			5 m			CIAH2-5		
			M12 (Socket-Female), L type			2 m	PVC	CLA2-2
						3 m		CLA2-3
						5 m	Oil resistant PVC	CLA2-5
						2 m		CLAH2-2
	M12 (Plug-Male)	2-wire	2 m	PVC	CLA2-5			
			5 m		CLAH2-5			
			2 m	Oil resistant PVC	CIA2-2P			
			5 m		CIA2-5P			
			M12 (Plug-Male), L type		2 m	PVC	CIAH2-2P	
					5 m		CIAH2-5P	
					2 m	Oil resistant PVC	CLA2-2P	
					5 m		CLA2-5P	
	AC	M12 (Socket-Female)	M12 (Plug-Male)	2 m	PVC	Photoelectric sensors / Proximity sensors / Safety door switches	C1A4-2	
				5 m			C1A4-5	
		M12 (Socket-Female), L type	M12 (Plug-Male), L type	2 m			C2A4-2	
				5 m			C2A4-5	
M12 (Socket-Female)		M12 (Plug-Male), L type	2 m		C3A4-2			
			5 m		C3A4-5			
M12 (Socket-Female), L type		M12 (Plug-Male)	2 m		C4A4-2			
			5 m		C4A4-5			
M12 (Plug-Male)		M12 (Plug-Male)	2 m		C1A4-2P			
			5 m		C1A4-5P			

Power	Connector 1	Connector 2	Length	Feature	Application	Model		
DC	M12 (Socket-Female)	2-wire	2 m	PVC	Photoelectric sensors / Proximity sensors / Safety door switches	CID2-2		
			5 m			CID2-5		
			2 m	Oil resistant PVC		CIDH2-2		
			5 m	PVC		CIDH2-5		
	M12 (Socket-Female), L type	2-wire	2 m	PVC		CLD2-2		
			5 m			CLD2-5		
			2 m	Oil resistant PVC		CLDH2-2		
			5 m	PVC		CLDH2-5		
	M12 (Socket-Female)	2-wire	2 m	PVC		Photoelectric sensors / Proximity sensors / Safety door switches	CID2-2-I	
			5 m				CID2-5-I	
			2 m	Oil resistant PVC			CIDH2-2-I	
			5 m	PVC			CIDH2-5-I	
	M12 (Socket-Female), L type	2-wire	2 m	PVC			CLD2-2-I	
			5 m				CLD2-5-I	
			2 m	Oil resistant PVC			CLDH2-2-I	
			5 m	PVC			CLDH2-5-I	
	M12 (Plug-Male)	2-wire	2 m	PVC	Photoelectric sensors / Proximity sensors / Safety door switches		CID2-2P	
			5 m				CID2-5P	
			2 m	Oil resistant PVC			CIDH2-2P	
			5 m	PVC			CIDH2-5P	
	M12 (Plug-Male), L type	2-wire	2 m	PVC			CLD2-2P	
			5 m				CLD2-5P	
			2 m	Oil resistant PVC			CLDH2-2P	
			5 m	PVC			CLDH2-5P	
	M12 (Socket-Female)	3-wire	2 m	PVC		Photoelectric sensors / Proximity sensors / Safety door switches	CID3-2	
			5 m				CID3-5	
			2 m	Oil resistant PVC			CIDH3-2	
			5 m	PVC			CIDH3-5	
	M12 (Socket-Female), L type	3-wire	2 m	PVC			CLD3-2	
			5 m				CLD3-5	
			2 m	Oil resistant PVC			CLDH3-2	
			5 m	PVC			CLDH3-5	
	M12 (Plug-Male)	3-wire	2 m	PVC	Photoelectric sensors / Proximity sensors / Safety door switches		CID3-2P	
			5 m				CID3-5P	
			2 m	Oil resistant PVC			CIDH3-2P	
			5 m	PVC			CIDH3-5P	
	M12 (Plug-Male), L type	3-wire	2 m	PVC			CLD3-2P	
			5 m				CLD3-5P	
			2 m	Oil resistant PVC			CLDH3-2P	
			5 m	PVC			CLDH3-5P	
	M12 (Socket-Female)	4-wire	2 m	Oil resistant PVC		Photoelectric sensors / Proximity sensors / Safety door switches	CIDH4-2	
			3 m	PVC			CIDH4-3	
			5 m				CIDH4-5	
			7 m				CIDH4-7	
			2 m	Oil resistant PVC			CIDH4-2-A	
			3 m	PVC			CIDH4-3-A	
			5 m				CIDH4-5-A	
			7 m				CIDH4-7-A	
			M12 (Socket-Female), L type	4-wire	2 m		Oil resistant PVC	CLDH4-2
					3 m		PVC	CLDH4-3
					5 m			CLDH4-5
					7 m			CLDH4-7
	M12 (Socket-Female), L type	4-wire	2 m	Oil resistant PVC	CLDH4-2-A			
			3 m	PVC	CLDH4-3-A			
			5 m		CLDH4-5-A			
			7 m		CLDH4-7-A			
M12 (Plug-Male)	4-wire	2 m	Oil resistant PVC	Photoelectric sensors / Proximity sensors / Safety door switches	CIDH4-2P			
		3 m	PVC		CIDH4-3P			
		5 m			CIDH4-5P			
		7 m			CIDH4-7P			
M12 (Plug-Male), L type	4-wire	2 m	Oil resistant PVC		CLDH4-2P			
		3 m	PVC		CLDH4-3P			
		5 m			CLDH4-5P			
		7 m			CLDH4-7P			

Power	Connector 1	Connector 2	Length	Feature	Application	Model				
DC	M12 (Socket-Female)	4-wire	3 m	Black (transmitter)	Area sensors BW Series / BWC Series	CID4-3T				
				Gray (receiver)		CID4-3R				
			5 m	Black (transmitter)		CID4-5T				
				Gray (receiver)		CID4-5R				
			7 m	Black (transmitter)		CID4-7T				
				Gray (receiver)		CID4-7R				
			10 m	Black (transmitter)		CID4-10T				
				Gray (receiver)		CID4-10R				
			15 m	Black (transmitter)		CID4-15T				
				Gray (receiver)		CID4-15R				
			DC	M12 (Socket-Female)		M12 (Plug-Male)	2 m	PVC	Photoelectric sensors / Proximity sensors / Safety door switches	C1D4-2
							5 m			C1D4-5
M12 (Socket-Female), L type	M12 (Plug-Male), L type	2 m		C2D4-2						
		5 m		C2D4-5						
M12 (Socket-Female)	M12 (Plug-Male), L type	2 m		C3D4-2						
		5 m		C3D4-5						
M12 (Socket-Female), L type	M12 (Plug-Male)	2 m		C4D4-2						
		5 m		C4D4-5						
M12 (Socket-Female)	M12 (Plug-Male)	1 m		Oil resistant PVC	C1DH4-1					
		3 m			C1DH4-3					
		5 m			C1DH4-5					
		7 m			C1DH4-7					
M12 (Socket-Female), L type	M12 (Plug-Male), L type	1 m			C2DH4-1					
		3 m			C2DH4-3					
		5 m			C2DH4-5					
		7 m			C2DH4-7					
M12 (Socket-Female)	M12 (Plug-Male), L type	1 m			C3DH4-1					
		3 m			C3DH4-3					
		5 m			C3DH4-5					
		7 m			C3DH4-7					
M12 (Socket-Female), L type	M12 (Plug-Male)	1 m		C4DH4-1						
		3 m		C4DH4-3						
		5 m		C4DH4-5						
		7 m		C4DH4-7						
M12 (Plug-Male)	M12 (Plug-Male)	2 m		PVC	C1D4-2P					
		5 m		C1D4-5P						

M12 Connector 5-Pin

Power	Connector 1	Connector 2	Length	Feature	Application	Model				
DC	M12 (Socket-Female)	5-wire	1 m	PVC	Safety non-contact door switches	CID5-1				
			2 m			CID5-2				
			3 m			CID5-3				
			5 m			CID5-5				
			7 m			CID5-7				
			M12 (Plug-Male)			1 m	CID5-1P			
						2 m	CID5-2P			
	3 m	CID5-3P								
	5 m	CID5-5P								
	7 m	CID5-7P								
	DC	M12 (Socket-Female)				M12 (Plug-Male)	1 m	PVC	Safety non-contact door switches	C1D5-1
							2 m			C1D5-2
			3 m				C1D5-3			
			5 m				C1D5-5			
7 m			C1D5-7							

M12 Connector 8-Pin

Power	Connector 1	Connector 2	Length	Feature	Application	Model		
DC	M12 (Socket-Female)	8-wire	2 m	Drag chain type 	Smart cameras ⁰¹⁾	CIDM8-2-A		
			5 m			CIDM8-5-A		
			10 m			CIDM8-10-A		
			M12 (Socket-Female), L type			2 m	CLDM8-2-A	
						5 m	CLDM8-5-A	
						10 m	CLDM8-10-A	
	M12 (Socket-Female)	8-wire	3 m	Transmitter	Safety light curtains ⁰²⁾	CID8-3T		
				Receiver		CID8-3R		
			5 m	Transmitter		CID8-5T		
				Receiver		CID8-5R		
			7 m	Transmitter		CID8-7T		
				Receiver		CID8-7R		
			10 m	Transmitter		CID8-10T		
				Receiver		CID8-10R		
				M12 (Plug-Male)		3 m	Transmitter	C1D8-3T
							Receiver	C1D8-3R
			5 m			Transmitter	C1D8-5T	
						Receiver	C1D8-5R	
			7 m			Transmitter	C1D8-7T	
						Receiver	C1D8-7R	
10 m	Transmitter	C1D8-10T						
	Receiver	C1D8-10R						
15 m	Transmitter	C1D8-15T						
	Receiver	C1D8-15R						
20 m	Transmitter	C1D8-20T						
	Receiver	C1D8-20R						

01) The cable for smart cameras are marked the specification.

02) To ordering the cable for safety light curtains, select the material specification.

M12 Connector 12-Pin

Power	Connector 1	Connector 2	Length	Application	Model
DC	M12 (Socket-Female)	12-wire	2 m	Vision sensors	CID-2-VG
			5 m		CID-5-VG
			10 m		CID-10-VG
	M12 (Socket-Female), L type		2 m		CLD-2-VG
			5 m		CLD-5-VG
			10 m		CLD-10-VG

Connector Cables

M17 Series



Features

- M17 Connector type 6-pin / 9-pin / 13-pin models available
- Various cable length (2m, 5m, 10m)
- Available in I-type connector
- Autonics application: Rotary Encoders

Specifications

M17 Connector 6-Pin

Connector 1	Connector 2	Length	Application	Model
M17 (Socket-Female)	6-wire	2 m	Incremental rotary encoders (Totem pole output / NPN open collector output / Voltage output)	CID6S-2
		5 m		CID6S-5
		10 m		CID6S-10
		15 m		CID6S-15

M17 Connector 9-Pin

Connector 1	Connector 2	Length	Application	Model
M17 (Socket-Female)	9-wire	2 m	Incremental rotary encoders (Line driver output)	CID9S-2
		5 m		CID9S-5
		10 m		CID9S-10

M17 Connector 13-Pin

Connector 1	Connector 2	Length	Application	Model
M17 (Socket-Female)	13-wire	2 m	-	CID13S-2
		5 m		CID13S-5
		10 m		CID13S-10
M17 (Socket-Female)	M17 (Plug-Male)	2 m	-	CID13P-2-SI
		5 m		CID13P-5-SI
		10 m		CID13P-10-SI

Connector Cables

M23 Series



Features

- M23 Connector type 12-pin / 19-pin models available
- Various cable length (4m, 6m, 7m, 8m)
- Available in L-type connector
- Autonics application: Distribution box

Specifications

M23 Connector 12-Pin

Connector 1	Connector 2	Length	Feature	Application	Model
M23 (Socket-Female)	11-wire	4 m	Oil resistant PVC	Distribution boxes	CLDH12C-040
		6 m			CLDH12C-060
		7 m			CLDH12C-070
		8 m			CLDH12C-080

M23 Connector 19-Pin

Connector 1	Connector 2	Length	Feature	Application	Model
M23 (Socket-Female)	19-wire	4 m	Oil resistant PVC	Distribution boxes	CLDH19C-040
		6 m			CLDH19C-060
		7 m			CLDH19C-070
		8 m			CLDH19C-080

I/O Cables

CH Series



Features

- Diverse cables available for connection to various PLCs and controllers
- Customizable cable arrangement
- Diverse cable lengths for various user requirements
- Customizable branching cable types

Specifications

Series	CH Series
Cable connector	PLC / SERVO side - Terminal block side
PLC / SERVO side	Hirose 20-pin / 40-pin socket, Fujitsu 40-pin socket, D-Sub 37-pin socket / plug MDR (latch) 20-pin / 26-pin / 50-pin socket, MDR (bolt) 26-pin / 50-pin socket
Terminal block side	Hirose 20-pin / 26-pin / 40-pin / 50-pin socket
Wire⁰¹⁾	UL 20276 TWIST 20C / 40C / 26C / 50C
Conductor characteristics	7 / 0.127 mm (AWG 28) × 20P, 7 / 0.127 mm (AWG 28) × 13P, 7 / 0.127 mm (AWG 28) × 10P, 7 / 0.127 mm (AWG 28) × 25P
Insulation diameter	0.12 mm ²
Cable diameter	∅ 6.3 mm (26C) / ∅ 7.2 mm (40C) / ∅ 8.9 mm (50C)
Rated current	≤ 1 A
Conductor resistance⁰²⁾	≤ 0.223 Ω/m
Insulation voltage	500 VAC~ 50/60Hz for 1 min
Insulation resistance	≥ 15 MΩ/km
Ambient temperature	-15 to 55°C, storage: -25 to 65°C (no freezing or condensation)
Ambient humidity	35 to 85 %RH, storage: 35 to 85 %RH (no freezing or condensation)

01) Color is black.

02) Conductor resistance value is rated at 20 °C.

[Unit weight : PLC cable]

• It excludes the package weight (+ 5 g). Unit weight is different depending on the cable length.

Type	No. of pin	Branching	Model	Weight
Hirose plug	20-pin	Non-branching	CH20-HP□-□	≈ 37 to 298 g
		Non-branching	CH40-HP□-□	≈ 58 to 391 g
	40-pin	2-branching	CH40-HP□-□-2S	≈ 55 to 388 g
		2-branching	CH40-HP□-□-2L	≈ 55 to 388 g
		2-branching	CH40-HP□-□-YS	≈ 58 to 391 g
		2-branching	CH40-HP□-□-FS	≈ 58 to 391 g
Fujitsu plug	40-pin	Non-branching	CH40-FP□-□	≈ 85 to 418 g
		2-branching	CH40-FP□-□-2S	≈ 88 to 421 g
		2-branching	CH40-FP□-□-2L	≈ 88 to 421 g
D-Sub plug	37-pin	Non-branching	CH37-DP□-□	≈ 90 to 423 g
		2-branching	CH37-DP□-□-2S	≈ 84 to 417 g
		2-branching	CH37-DP□-□-2L	≈ 84 to 417 g
D-Sub Socket	37-pin	Non-branching	CH37-DS□-□	≈ 90 to 423 g
		2-branching	CH37-DS□-□-2S	≈ 84 to 417 g
		2-branching	CH37-DS□-□-2L	≈ 84 to 417 g

[Unit weight : SERVO cable]

• It excludes the package weight (+ 5 g). Unit weight is different depending on the cable length.

Type	No. of pin	Model	Weight
3M plug (latch)	20-pin	CH20-MP□-□	≈ 46 to 301 g
	26-pin	CH26-MP□-□	≈ 72 to 267 g
	50-pin	CH50-MP□-□	≈ 95 to 587 g
3M plug (bolt)	26-pin	CH26-MQ□-□	≈ 74 to 269 g
	50-pin	CH50-MQ□-□	≈ 98 to 590 g

I/O Cables

CO Series



Features

- Diverse cables available for connection to various PLCs and controller
- Diverse cable lengths for various user requirements

Specifications

Series	CO Series
Cable connector	Hirose 20-pin / 40-pin socket, Fujitsu 40-pin socket, D-sub 37-pin socket / plug, MDR (latch) 20-pin / 26-pin / 50-pin socket, MDR (bolt) 26-pin socket
Wire ⁰¹⁾	UL 20276 TWIST 20C / 26C / 40C / 50C
Conductor characteristics	7 / 0.127 mm (AWG 28) × 20P, 7 / 0.127 mm (AWG 28) × 13P, 7 / 0.127 mm (AWG 28) × 10P, 7 / 0.127 mm (AWG 28) × 25P
Insulation diameter	0.12 mm ²
Cable diameter	∅ 6.3 mm (26C) / ∅ 7.2 mm (40C) / ∅ 8.9 mm (50C)
Rated current	≤ 1 A
Conductor resistance ⁰²⁾	≤ 0.223 Ω/m
Insulation voltage	500 VAC ~ 50/60Hz for 1 min
Insulation resistance	≥ 15 MΩ/km
Ambient temperature	-15 to 55 °C, storage : -25 to 65 °C (no freezing or condensation)
Ambient humidity	35 to 85 %RH, storage : 35 to 85 %RH (no freezing or condensation)

01) Color is black.

02) Conductor resistance value is rated at 20 °C.

[Unit weight : PLC cable]

• It excludes the package weight (+ 5 g). Unit weight is different depending on the cable length.

Type	No. of pin	Model	Weight
Hirose plug	20-pin	CO20-HP□-□	≈ 33 to 294 g
	40-pin	CO40-HP□-□	≈ 33 to 324 g
	50-pin	CO50-HP□-□	≈ 102 to 414 g
Fujitsu plug	40-pin	CO40-FP□-□	≈ 83 to 360 g
D-Sub plug	37-pin	CO37-DP□-□	≈ 88 to 365 g
D-Sub socket	37-pin	CO37-DS□-□	≈ 88 to 365 g

[Unit weight : SERVO cable]

• It excludes the package weight (+ 5 g). Unit weight is different depending on the cable length.

Type	No. of pin	Model	Weight ⁰¹⁾
3M plug (latch)	20-pin	CO20-MP□-□	≈ 50 to 311 g
	26-pin	CO26-MP□-□	≈ 62 to 279 g
	50-pin	CO26-MQ□-□	≈ 64 to 281 g
3M plug (screw)	26-pin	CO50-MP□-□	≈ 110 to 422 g

01) It excludes the package weight (+ 5 g). Unit weight is different depending on the cable length.

D-SUB Connector

Communication Cables

D-SUB Series



Features

- D-Sub 9-pin Connector type available
- Available in various wire connection
- Autonics application: HMIs

Specifications

M12 Connector Communication Cables

M12 Series

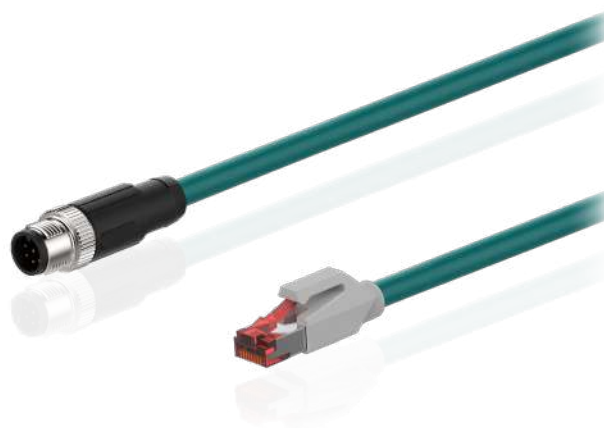

Features

- M12 Connector type 4-pin / 5-pin / 8-pin / 12-pin models available
- Various cable length (2m, 5m, 10m)
- Available in I-type connector, L-type connector, cable type
- Standard and moving type cables available
- IP67 protection structure (IEC standard)
- Autonics application: Smart cameras, Vision sensors, LiDAR

Specifications

M12 Connector 8-Pin

Connector 1	Connector 2	Length	Feature	Application	Model
M12 (Plug-Male)	RJ45	2 m	-	Vision sensors	CIR-2-VG
		5 m			CIR-5-VG
		10 m			CIR-10-VG
M12 (Plug-Male), L type	RJ45	2 m	-	Vision sensors	CLR-2-VG
		5 m			CLR-5-VG
		10 m			CLR-10-VG
M12 (Plug-Male)	RJ45	2 m	Drag chain type	Smart cameras ⁰¹⁾	C1M8-2PR-A
		5 m			C1M8-5PR-A
		10 m			C1M8-10PR-A
M12 (Plug-Male), L type	RJ45	2 m	-	Smart cameras ⁰¹⁾	C4M8-2PR-A
		5 m			C4M8-5PR-A
		10 m			C4M8-10PR-A
M12 (Plug-Male)	-	2 m	-	Smart cameras ⁰¹⁾	C18-2PR-A
		5 m			C18-5PR-A
		10 m			C18-10PR-A
M12 (Plug-Male), L type	-	2 m	-	Smart cameras ⁰¹⁾	C48-2PR-A
		5 m			C48-5PR-A
		10 m			C48-10PR-A

01) The cable for smart cameras are marked the specification.

Connector 1	Connector 2	Length	Feature	Application	Model
M12 (Socket-Female)	RJ45	2 m	-	LiDAR LSC Series	C18-2R-A
		5 m			C18-5R-A
		10 m			C18-10R-A
M12 (Socket-Female), L type	RJ45	2 m	-	LiDAR LSC Series	C48-2R-A
		5 m			C48-5R-A
		10 m			C48-10R-A

Valve Plug

Cables

CV Series

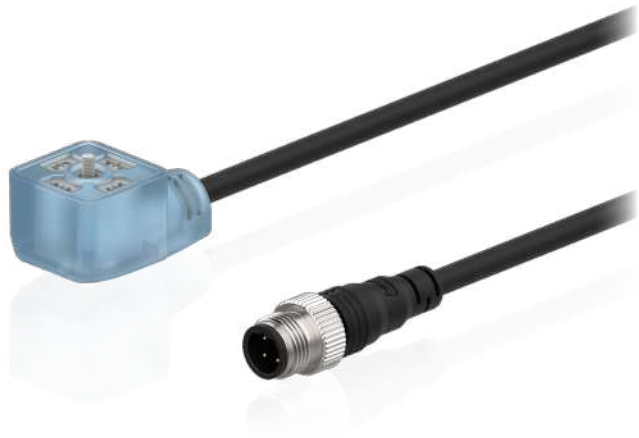

Features

- Available in I-type connector, L-type connector, cable type
- Screw mount connection for strong connectivity
- Excellent oil-resistance, abrasion resistance

Specifications

Model	CVA / CVC Series	
Removable durability	Max. 200 operations	
Cable tension	10 kgf (100 N)	
Tightening	M3 × 0.5	
Tightening torque	0.4 to 0.6 N.m M12 nut: 0.6 to 0.7 N.m	
Connections	Cable connector / cable type model	
Cable diameter	Ø 5 ± 0.2 mm	
Wire	3C × 0.3 mm ² (AWG22 - 0.08 × 60)	
Flexion	Over 1,000 operations	
Protection structure	IP67	
Plug material	Jacket: TPU Socket: MPPO Name plate: PC Bolt: SWCH 10A Pin: BRASS / NIKEL-PLATED	
Connector material	Jacket: TPU Socket: PA6 Pin: BRASS / NIKEL-PLATED	
Cable material	PVC	
Unit weight (packaged) ⁰¹⁾	CVA: ≈ 68g (≈ 73.1g) CVC: ≈ 55g (≈ 60.1g)	
01) Based on CVA/CVC-□□□-3010-I. Add ≈ 35 g by cable 1 m.		
Power supply	24 VAC~ 50 / 60 Hz, 24 VDC≐	24 VDC≐
Rated current	≤ 2 A	
Conductor resistance	≤ 60.12 Ω/km (AWG22)	
Insulation resistance	≥ 1000 MΩ (500 VDC≐ megger)	
Dielectric strength	2000 VAC~ 50 / 60 Hz for 1 min	
Vibration	1 mm amplitude at frequency of 10 to 55 Hz (for 1 min) in each X, Y, Z direction for 1 hour	
Shock	500 m/s ² (≈ 50 G) in each X, Y, Z direction for 3 times	
Ambient temperature	-25 to 70 °C, storage: -30 to 80 °C (no freezing or condensation)	
Ambient humidity	35 to 85%RH, storage: 35 to 85%RH (no freezing or condensation)	

J. Switches

Extensive range of control switches are available including push buttons, selector switches, emergency switches, pilot lights, buzzers, and more.

J1. Control Switches







J1. Control Switches

Control switches maximize device control efficiency with fluid operation mechanics and high durability.

J1-1	Ø 16 mm Switches / Pilot Light	S16PR Series	Ø 16 mm Push Button Switches
		S16SR Series	Ø 16 mm Selector Switches
		S16KR Series	Ø 16 mm Key Selector Switches
		S16BR Series	Ø 16 mm Mushroom-Head Push Button Switches
		S16ER Series	Ø 16 mm Emergency Switches
		L16RR Series	Ø 16 mm Pilot Lights
J1-2	Ø 22 / 25 mm Switches / Pilot Light	S2PR Series	Ø 22 / 25 mm Push Button Switches
		S2SR Series	Ø 22 / 25 mm Selector Switches
		S2KR Series	Ø 22 / 25 mm Key Selector Switches
		S2TR Series	Ø 22 / 25 mm I/O Push Button Switches
		S2BR Series	Ø 22 / 25 mm Mushroom-Head Push Button Switches
		S2ER Series	Ø 22 / 25 mm Emergency Switches
		L2RR Series	Ø 22 / 25 mm Pilot Lights
		J1-3	Ø 30 mm Switches / Pilot Light
S3SF Series	Ø 30 mm Selector Switches		
S3KF Series	Ø 30 mm Key Selector Switches		
L3RF Series	Ø 30 mm Pilot Lights		
J1-4	□ 30 mm Switches / Pilot Light	SQ3PF Series	□ 30 mm Push Button Switches
		LQ3RF Series	□ 30 mm Pilot Lights
J1-5	Magnetic Switches	MN Series	Magnetic Non-Contact Switches

Ø 16 mm Push Button Switches

S16PR Series



Features

- Compact, space-saving 16 mm installation diameter
- Short rear-length size of only 29.5 mm
- Independent detachable contacts

Specifications

Series	S16PR Series				
Actuation distance	3 mm				
Actuation force	0.2 to 0.35 kgf (2 to 3.5 N)				
Installation	Extended				
Shock	500 m/s ² (≈ 30 G) in each X, Y, Z direction for 3 times				
Shock (malfunction)	100 m/s ² (≈ 10 G) in each X, Y, Z direction for 3 times				
Vibration	1.5 mm amplitude at frequency of 10 to 55 Hz (for 1 min) in each X, Y, Z direction for 2 hours				
Vibration (malfunction)	1.5 mm amplitude at frequency of 10 to 55 Hz (for 1 min) in each X, Y, Z direction for 10 minutes				
Mechanical life cycle (control unit life cycle)	Returned: ≥ 1 million operations (20 operations/min) Maintained: ≥ 200,000 operations (20 operations/min)				
Ambient temperature	-15 to 55 °C, storage : -25 to 65 °C (no freezing or condensation)				
Ambient humidity	35 to 85 %RH, storage : 35 to 85 %RH (no freezing or condensation)				
Protection structure	Control unit: IP65 (IEC standard)				
Approval	CE 01 TÜV ERIC				
Control unit weight	Round: ≈ 3.8 g, Square: ≈ 4.4 g, Rectangular: ≈ 5.1 g				
Housing weight	≈ 1.4 g				
01) IEC-60947-5-1					
Contact blocks					
Power supply/current	250 VAC~ / 3 A				
Dielectric strength	2,000 VAC~ 50/60 Hz for 1 minute (between other polarities), 1,000 VAC~ 50/60 Hz for 1 minute (between same polarities)				
Insulation resistance	≥ 100 MΩ (500 VDC⇒ megger)				
Contact resistance	≤ 50 mΩ (initial)				
Electrical life cycle	≥ 100,000 operations (20 operations/min)				
Contact material	AgNi10				
Terminal tensile force	≤ 30 N				
Terminal soldering time	At the end of tips within 3 sec with 350 °C (30 W-soldering machine)				
Approval	CE TÜV ERIC				
Weight	≈ 1.6 g				
LED blocks					
Rated voltage	5 / 12 / 24 VDC⇒ model				
Current consumption	Refer to the below Current consumption table.				
Approval	CE TÜV ERIC				
Weight	≈ 1.9 g				
Current consumption	Red	Blue	Green	Yellow	White
SA16-L5□ (5 VDC⇒)	6 to 9 mA	10 to 14 mA	5 to 7 mA	12 to 16 mA	10 to 14 mA
SA16-L12□ (12 VDC⇒)	9 to 14 mA	10 to 15 mA	5 to 9 mA	10 to 16 mA	9 to 14 mA
SA16-L24□ (24 VDC⇒)	15 to 20 mA	20 to 26 mA	16 to 22 mA	27 to 35 mA	23 to 30 mA

Ø 16 mm Selector Switches

S16SR Series



Features

- Compact, space-saving 16 mm installation diameter
- Short rear-length size of only 29.5 mm
- Independent detachable contacts

Specifications

Series	S16SR Series				
Actuation angle	2-position: 90°±5°, 3-position: 45°±5°				
Actuation force	20 to 120 N·mm				
Installation	Extended				
Shock	500 m/s ² (≈ 30 G) in each X, Y, Z direction for 3 times				
Shock (malfunction)	100 m/s ² (≈ 10 G) in each X, Y, Z direction for 3 times				
Vibration	1.5 mm amplitude at frequency of 10 to 55 Hz (for 1 min) in each X, Y, Z direction for 2 hours				
Vibration (malfunction)	1.5 mm amplitude at frequency of 10 to 55 Hz (for 1 min) in each X, Y, Z direction for 10 minutes				
Mechanical life cycle (control unit life cycle)	≥ 250,000 operations (20 operations/min)				
Ambient temperature	-15 to 55 °C, storage : -25 to 65 °C (no freezing or condensation)				
Ambient humidity	35 to 85 %RH, storage : 35 to 85 %RH (no freezing or condensation)				
Protection structure	Control unit: IP65 (IEC standard)				
Approval	CE ⁰¹⁾				
Control unit weight	Round: ≈ 6.6 g, Square: ≈ 6.8 g, Rectangular: ≈ 7.7 g				
Housing weight	≈ 1.4 g				
01) IEC-60947-5-1					
Contact blocks					
Power supply/current	250 VAC~ / 3 A				
Dielectric strength	2,000 VAC~ 50/60 Hz for 1 minute (between other polarities), 1,000 VAC~ 50/60 Hz for 1 minute (between same polarities)				
Insulation resistance	≥ 100 MΩ (500 VDC= megger)				
Contact resistance	≤ 50 mΩ (initial)				
Electrical life cycle	≥ 100,000 operations (20 operations/min)				
Contact material	AgNi10				
Terminal tensile force	≤ 30 N				
Terminal soldering time	At the end of tips within 3 sec with 350 °C (30 W-soldering machine)				
Approval	CE				
Weight	≈ 1.6 g				
LED blocks					
Rated voltage	5 / 12 / 24 VDC= model				
Current consumption	Refer to the below Current consumption table.				
Approval	CE				
Weight	≈ 1.9 g				
Current consumption	Red	Blue	Green	Yellow	White
SA16-L5□ (5 VDC=)	6 to 9 mA	10 to 14 mA	5 to 7 mA	12 to 16 mA	10 to 14 mA
SA16-L12□ (12 VDC=)	9 to 14 mA	10 to 15 mA	5 to 9 mA	10 to 16 mA	9 to 14 mA
SA16-L24□ (24 VDC=)	15 to 20 mA	20 to 26 mA	16 to 22 mA	27 to 35 mA	23 to 30 mA

Ø 16 mm Key Selector Switches

S16KR Series



Features

- Compact, space-saving 16 mm installation diameter
- Short rear-length size of only 29.5 mm
- Independent detachable contacts

Specifications

Series	S16KR Series				
Actuation angle	2-position: 90°±5°, 3-position: 45°±5°				
Actuation force	20 to 120 N·mm				
Installation	Extended				
Shock	500 m/s ² (≈ 30 G) in each X, Y, Z direction for 3 times				
Shock (malfunction)	100 m/s ² (≈ 10 G) in each X, Y, Z direction for 3 times				
Vibration	1.5 mm amplitude at frequency of 10 to 55 Hz (for 1 min) in each X, Y, Z direction for 2 hours				
Vibration (malfunction)	1.5 mm amplitude at frequency of 10 to 55 Hz (for 1 min) in each X, Y, Z direction for 10 minutes				
Mechanical life cycle (control unit life cycle)	≥ 250,000 operations (20 operations/min)				
Ambient temperature	-15 to 55 °C, storage : -25 to 65 °C (no freezing or condensation)				
Ambient humidity	35 to 85 %RH, storage : 35 to 85 %RH (no freezing or condensation)				
Protection structure	Control unit: IP65 (IEC standard)				
Approval	CE 01, RoHS, ENEC, ENEC				
Control unit weight	Round: ≈ 16 g, Square: ≈ 16.2 g, Rectangular: ≈ 17.1 g				
Housing weight	≈ 1.4 g				
01) IEC-60947-5-1					
Contact blocks					
Power supply/current	250 VAC~ / 3 A				
Dielectric strength	2,000 VAC~ 50/60 Hz for 1 minute (between other polarities), 1,000 VAC~ 50/60 Hz for 1 minute (between same polarities)				
Insulation resistance	≥ 100 MΩ (500 VDC⇒ megger)				
Contact resistance	≤ 50 mΩ (initial)				
Electrical life cycle	≥ 100,000 operations (20 operations/min)				
Contact material	AgNi10				
Terminal tensile force	≤ 30 N				
Terminal soldering time	At the end of tips within 3 sec with 350 °C (30 W-soldering machine)				
Approval	CE, RoHS, ENEC, ENEC				
Weight	≈ 1.6 g				
LED blocks					
Rated voltage	5 / 12 / 24 VDC⇒ model				
Current consumption	Refer to the below Current consumption table.				
Approval	CE, RoHS, ENEC, ENEC				
Weight	≈ 1.9 g				
Current consumption	Red	Blue	Green	Yellow	White
SA16-L5□ (5 VDC⇒)	6 to 9 mA	10 to 14 mA	5 to 7 mA	12 to 16 mA	10 to 14 mA
SA16-L12□ (12 VDC⇒)	9 to 14 mA	10 to 15 mA	5 to 9 mA	10 to 16 mA	9 to 14 mA
SA16-L24□ (24 VDC⇒)	15 to 20 mA	20 to 26 mA	16 to 22 mA	27 to 35 mA	23 to 30 mA

Ø 16 mm Mushroom-Head Push Button Switches

S16BR Series



Features

- Compact, space-saving 16 mm installation diameter
- Short rear-length size of only 29.5 mm
- Independent detachable contacts

Specifications

Series	S16BR Series
Actuation distance	3 mm
Actuation force	0.2 to 0.35 kgf (2 to 3.5 N)
Installation	Extended
Shock	500 m/s ² (≈ 30 G) in each X, Y, Z direction for 3 times
Shock (malfunction)	100 m/s ² (≈ 10 G) in each X, Y, Z direction for 3 times
Vibration	1.5 mm amplitude at frequency of 10 to 55 Hz (for 1 min) in each X, Y, Z direction for 2 hours
Vibration (malfunction)	1.5 mm amplitude at frequency of 10 to 55 Hz (for 1 min) in each X, Y, Z direction for 10 minutes
Mechanical life cycle (control unit life cycle)	≥ 1 million operations (20 operations/min)
Ambient temperature	-15 to 55 °C, storage : -25 to 65 °C (no freezing or condensation)
Ambient humidity	35 to 85 %RH, storage : 35 to 85 %RH (no freezing or condensation)
Protection structure	Control unit: IP65 (IEC standard)
Approval	CE ⁰¹⁾ RoHS ENEC
Control unit weight	≈ 4.1 g
Housing weight	≈ 1.4 g

01) IEC-60947-5-1

Contact blocks	
Power supply/current	250 VAC~ / 3 A
Dielectric strength	2,000 VAC~ 50/60 Hz for 1 minute (between other polarities), 1,000 VAC~ 50/60 Hz for 1 minute (between same polarities)
Insulation resistance	≥ 100 MΩ (500 VDC= megger)
Contact resistance	≤ 50 mΩ (initial)
Electrical life cycle	≥ 100,000 operations (20 operations/min)
Contact material	AgNi10
Terminal tensile force	≤ 30 N
Terminal soldering time	At the end of tips within 3 sec with 350 °C (30 W-soldering machine)
Approval	CE RoHS ENEC
Weight	≈ 1.6 g

LED blocks	
Rated voltage	5 / 12 / 24 VDC= model
Current consumption	Refer to the below Current consumption table.
Approval	CE RoHS ENEC
Weight	≈ 1.9 g

Current consumption	Red	Blue	Green	Yellow	White
SA16-L5□ (5 VDC=)	6 to 9 mA	10 to 14 mA	5 to 7 mA	12 to 16 mA	10 to 14 mA
SA16-L12□ (12 VDC=)	9 to 14 mA	10 to 15 mA	5 to 9 mA	10 to 16 mA	9 to 14 mA
SA16-L24□ (24 VDC=)	15 to 20 mA	20 to 26 mA	16 to 22 mA	27 to 35 mA	23 to 30 mA

Ø 16 mm Emergency Switches

S16ER Series



Features

- Compact, space-saving 16 mm installation diameter
- Short rear-length size of only 29.5 mm
- Independent detachable contacts

Specifications

Series	S16ER Series
Actuation distance	2 to 4 mm
Actuation angle	35° ± 7°
Actuation force	1.7 to 4.7 kgf (17 to 47 N)
Installation	Extended
Shock	500 m/s ² (≈ 30 G) in each X, Y, Z direction for 3 times
Shock (malfunction)	100 m/s ² (≈ 10 G) in each X, Y, Z direction for 3 times
Vibration	1.5 mm amplitude at frequency of 10 to 55 Hz (for 1 min) in each X, Y, Z direction for 2 hours
Vibration (malfunction)	1.5 mm amplitude at frequency of 10 to 55Hz (for 1 min) in each X, Y, Z direction for 10 minutes
Mechanical life cycle (control unit life cycle)	≥ 100,000 operations (20 operations/min)
Ambient temperature	-15 to 55 °C, storage : -25 to 65 °C (no freezing or condensation)
Ambient humidity	35 to 85 %RH, storage : 35 to 85 %RH (no freezing or condensation)
Protection structure	Control unit: IP65 (IEC standard)
Approval	CE 01, TÜV, ENEC, ENEC
Control unit weight	≈ 11.5 g
Housing weight	≈ 1.4 g

01) IEC-60947-5-1

Contact blocks					
Power supply/current	250 VAC~ / 3 A				
Dielectric strength	2,000 VAC~ 50/60 Hz for 1 minute (between other polarities), 1,000 VAC~ 50/60 Hz for 1 minute (between same polarities)				
Insulation resistance	≥ 100 MΩ (500 VDC== megger)				
Contact resistance	≤ 50 mΩ (initial)				
Electrical life cycle	≥ 100,000 operations (20 operations/min)				
Contact material	AgNi10				
Terminal tensile force	≤ 30 N				
Terminal soldering time	At the end of tips within 3 sec with 350 °C (30 W-soldering machine)				
Approval	CE, TÜV, ENEC, ENEC				
Weight	≈ 1.6 g				
LED blocks					
Rated voltage	5 / 12 / 24 VDC== model				
Current consumption	Refer to the below Current consumption table.				
Approval	CE, TÜV, ENEC, ENEC				
Weight	≈ 1.9 g				
Current consumption	Red	Blue	Green	Yellow	White
SA16-L5□ (5 VDC==)	6 to 9 mA	10 to 14 mA	5 to 7 mA	12 to 16 mA	10 to 14 mA
SA16-L12□ (12 VDC==)	9 to 14 mA	10 to 15 mA	5 to 9 mA	10 to 16 mA	9 to 14 mA
SA16-L24□ (24 VDC==)	15 to 20 mA	20 to 26 mA	16 to 22 mA	27 to 35 mA	23 to 30 mA

Ø 16 mm Pilot Lights

L16RR Series



Features

- Compact, space-saving 16 mm installation diameter
- Short rear-length size of only 29.5 mm

Specifications

Series	L16RR Series
Installation	Extended
Shock	500 m/s ² (≈ 30 G) in each X, Y, Z direction for 3 times
Shock (malfunction)	100 m/s ² (≈ 10 G) in each X, Y, Z direction for 3 times
Vibration	1.5 mm amplitude at frequency of 10 to 55 Hz (for 1 min) in each X, Y, Z direction for 2 hours
Vibration (malfunction)	1.5 mm amplitude at frequency of 10 to 55 Hz (for 1 min) in each X, Y, Z direction for 10 minutes
Ambient temperature	-15 to 55 °C, storage : -25 to 65 °C (no freezing or condensation)
Ambient humidity	35 to 85 %RH, storage : 35 to 85 %RH (no freezing or condensation)
Protection structure	Light unit: IP65 (IEC standard)
Approval	CE ⁽⁰¹⁾ cULus ENEC
Light unit weight	≈ 11.5 g
Housing weight	≈ 1.4 g

01) IEC-60947-5-1

LED blocks					
Rated voltage	5 / 12 / 24 VDC⇒ model				
Current consumption	Refer to the below Current consumption table.				
Approval	CE ⁽⁰¹⁾ cULus ENEC				
Weight	≈ 1.9 g				
Current consumption	Red	Blue	Green	Yellow	White
SA16-L5□ (5 VDC⇒)	6 to 9 mA	10 to 14 mA	5 to 7 mA	12 to 16 mA	10 to 14 mA
SA16-L12□ (12 VDC⇒)	9 to 14 mA	10 to 15 mA	5 to 9 mA	10 to 16 mA	9 to 14 mA
SA16-L24□ (24 VDC⇒)	15 to 20 mA	20 to 26 mA	16 to 22 mA	27 to 35 mA	23 to 30 mA

Ø 22 / 25 mm

Push Button Switches

S2PR Series



Features

- Smooth operation
- High electrical conductivity
- Long-lasting durability

Specifications

Series	S2PR Series
Actuation distance	5.0 to 5.5 mm
Actuation force	0.5 kgf (4.9 N) (per 1 contact)
Installation	Extended
Shock	300 m/s ² (≈ 30 G) in each X, Y, Z direction for 3 times
Shock (malfunction)	100 m/s ² (≈ 10 G) in each X, Y, Z direction for 3 times
Vibration	1.5 mm amplitude at frequency of 10 to 55 Hz (for 1 min) in each X, Y, Z direction for 2 hours
Vibration (malfunction)	1.5 mm amplitude at frequency of 10 to 55Hz (for 1 min) in each X, Y, Z direction for 10 minutes
Mechanical life cycle (control unit life cycle)	Returned: ≥ 1 million operations (20 operations/min)
Ambient temperature	-15 to 55 °C, storage : -25 to 65 °C (no freezing or condensation)
Ambient humidity	35 to 85 %RH, storage : 35 to 85 %RH (no freezing or condensation)
Protection structure	Control unit: IP52 (IEC standard)
Approval	CE
Control unit weight	Round : ≈ 14.5 g, Square: ≈ 15.5 g
Housing weight	≈ 7 g
Contact blocks	
Power supply / current	110 VAC~ / 10 A, 250 VAC~ / 6 A
Dielectric strength	2,500 VAC~ 50/60 Hz for 1 minute
Insulation resistance	≥ 1,000 MΩ (500 VDC≡ megger)
Contact resistance	≤ 20 mΩ (initial)
Electrical life cycle	≥ 100,000 operations (20 operations/min)
Contact material	AgNi10
Approval	CE
Weight	Modular type: ≈ 10 g, Singular type: ≈ 11 g
LED blocks	
Rated voltage	AC/DC voltage type: 12-24 VAC~ 50/60 Hz, 12-24 VDC≡ AC voltage type: 110-220 VAC~ 50/60 Hz
Current consumption	≤ 20 mA
Approval	CE
Weight	AC/DC voltage type: ≈ 11 g, AC voltage type: ≈ 12 g

Ø 22 / 25 mm Selector Switches

S2SR Series



Features

- Smooth operation
- High electrical conductivity
- Long-lasting durability

Specifications

Series	S2SR Series
Actuation angle	2-position: [Spring return] 60° ±5°, 90° ±5° [Maintained] 90° ±5° 3-position: [Spring return] 60° ±5°, 45° ±5° [Maintained] 90° ±5°, 45° ±5°
Actuation force	0.5 kgf (4.9 N) (per 1 contact)
Installation	Extended
Shock	300 m/s ² (≈ 30 G) in each X, Y, Z direction for 3 times
Shock (malfunction)	100 m/s ² (≈ 10 G) in each X, Y, Z direction for 3 times
Vibration	1.5 mm amplitude at frequency of 10 to 55 Hz (for 1 min) in each X, Y, Z direction for 2 hours
Vibration (malfunction)	1.5 mm amplitude at frequency of 10 to 55 Hz (for 1 min) in each X, Y, Z direction for 10 minutes
Mechanical life cycle (control unit life cycle)	≥ 100,000 operations (20 operations/min)
Ambient temperature	-15 to 55 °C, storage : -25 to 65 °C (no freezing or condensation)
Ambient humidity	35 to 85 %RH, storage : 35 to 85 %RH (no freezing or condensation)
Protection structure	Control unit: IP52 (IEC standard)
Approval	CE
Control unit weight	Standard head type: ≈ 19 g Shark-head type: ≈ 16 g
Housing weight	≈ 7 g
Contact blocks	
Power supply / current	110 VAC~ / 10 A, 250 VAC~ / 6 A
Dielectric strength	2,500 VAC~ 50/60 Hz for 1 minute
Insulation resistance	≥ 1,000 MΩ (500 VDC== megger)
Contact resistance	≤ 20 mΩ (initial)
Electrical life cycle	≥ 100,000 operations (20 operations/min)
Contact material	AgNi10
Approval	CE
Weight	Modular type: ≈ 10 g, Singular type: ≈ 11 g
LED blocks	
Rated voltage	AC/DC voltage type: 12-24 VAC~ 50/60 Hz, 12-24 VDC== AC voltage type: 110-220 VAC~ 50/60 Hz
Current consumption	≤ 20 mA
Approval	CE
Weight	AC/DC voltage type: ≈ 11 g, AC voltage type: ≈ 12 g

Ø 22 / 25 mm

Key Selector Switches

S2KR Series



Features

- Smooth operation
- High electrical conductivity
- Long-lasting durability

Specifications

Series	S2KR Series
Actuation angle	2-position: [Spring return] 60° ±5° [Maintained] 90° ±5° 3-position: [Spring return] 60° ±5° [Maintained] 90° ±5°
Actuation force	0.5 kgf (4.9 N) (per 1 contact)
Installation	Extended
Shock	300 m/s ² (≈ 30 G) in each X, Y, Z direction for 3 times
Shock (malfunction)	100 m/s ² (≈ 10 G) in each X, Y, Z direction for 3 times
Vibration	1.5 mm amplitude at frequency of 10 to 55 Hz (for 1 min) in each X, Y, Z direction for 2 hours
Vibration (malfunction)	1.5 mm amplitude at frequency of 10 to 55Hz (for 1 min) in each X, Y, Z direction for 10 minutes
Mechanical life cycle (control unit life cycle)	≥ 100,000 operations (20 operations/min)
Ambient temperature	-15 to 55 °C, storage : -25 to 65 °C (no freezing or condensation)
Ambient humidity	35 to 85 %RH, storage : 35 to 85 %RH (no freezing or condensation)
Protection structure	Control unit: IP52 (IEC standard)
Approval	CE
Control unit weight	≈ 37 g
Housing weight	≈ 7 g
Contact blocks	
Power supply / current	110 VAC~ / 10 A, 250 VAC~ / 6 A
Dielectric strength	2,500 VAC~ 50/60 Hz for 1 minute
Insulation resistance	≥ 1,000 MΩ (500 VDC= megger)
Contact resistance	≤ 20 mΩ (initial)
Electrical life cycle	≥ 100,000 operations (20 operations/min)
Contact material	AgNi10
Approval	CE
Weight	Modular type: ≈ 10 g, Singular type: ≈ 11 g

Ø 22 / 25 mm

I/O Push Button

Switches

S2TR Series



Features

- Smooth operation
- High electrical conductivity
- Long-lasting durability

Specifications

Series	S2TR Series
Actuation distance	5.0 to 5.5 mm
Actuation force	0.5 kgf (4.9 N) (per 1 contact)
Installation	Extended
Shock	300 m/s ² (≈ 30 G) in each X, Y, Z direction for 3 times
Shock (malfunction)	100 m/s ² (≈ 10 G) in each X, Y, Z direction for 3 times
Vibration	1.5 mm amplitude at frequency of 10 to 55 Hz (for 1 min) in each X, Y, Z direction for 2 hours
Vibration (malfunction)	1.5 mm amplitude at frequency of 10 to 55Hz (for 1 min) in each X, Y, Z direction for 10 minutes
Mechanical life cycle (control unit life cycle)	≥ 1 million operations (20 operations/min)
Ambient temperature	-15 to 55 °C, storage : -25 to 65 °C (no freezing or condensation)
Ambient humidity	35 to 85 %RH, storage : 35 to 85 %RH (no freezing or condensation)
Protection structure	Control unit: IP50 (IEC standard)
Approval	CE
Control unit weight	≈ 14.5 g
Housing weight	≈ 7 g
Contact blocks	
Power supply / current	110 VAC~ / 10 A, 250 VAC~ / 6 A
Dielectric strength	2,500 VAC~ 50/60 Hz for 1 minute
Insulation resistance	≥ 1,000 MΩ (500 VDC== megger)
Contact resistance	≤ 20 mΩ (initial)
Electrical life cycle	≥ 100,000 operations (20 operations/min)
Contact material	AgNi10
Approval	CE
Weight	Modular type: ≈ 10 g, Singular type: ≈ 11 g
LED blocks	
Rated voltage	AC/DC voltage type: 12-24 VAC~ 50/60 Hz, 12-24 VDC== AC voltage type: 110-220 VAC~ 50/60 Hz
Current consumption	≤ 20 mA
Approval	CE
Weight	AC/DC voltage type: ≈ 11 g, AC voltage type: ≈ 12 g

Ø 22 / 25 mm

Mushroom-Head

Push Button

Switches

S2BR Series



Features

- Smooth operation
- High electrical conductivity
- Long-lasting durability

Specifications

Series	S2BR Series
Actuation distance	5.0 to 5.5 mm
Actuation force	0.5 kgf (4.9 N) (per 1 contact)
Installation	Extended
Shock	300 m/s ² (≈ 30 G) in each X, Y, Z direction for 3 times
Shock (malfunction)	100 m/s ² (≈ 10 G) in each X, Y, Z direction for 3 times
Vibration	1.5 mm amplitude at frequency of 10 to 55 Hz (for 1 min) in each X, Y, Z direction for 2 hours
Vibration (malfunction)	1.5 mm amplitude at frequency of 10 to 55 Hz (for 1 min) in each X, Y, Z direction for 10 minutes
Mechanical life cycle (control unit life cycle)	≥ 1 million operations (20 operations/min)
Ambient temperature	-15 to 55 °C, storage : -25 to 65 °C (no freezing or condensation)
Ambient humidity	35 to 85 %RH, storage : 35 to 85 %RH (no freezing or condensation)
Protection structure	Control unit: IP52 (IEC standard)
Approval	CE
Control unit weight	≈ 21 g
Housing weight	≈ 7 g
Contact blocks	
Power supply / current	110 VAC~ / 10 A, 250 VAC~ / 6 A
Dielectric strength	2,500 VAC~ 50/60 Hz for 1 minute
Insulation resistance	≥ 1,000 MΩ (500 VDC≡ megger)
Contact resistance	≤ 20 mΩ (initial)
Electrical life cycle	≥ 100,000 operations (20 operations/min)
Contact material	AgNi10
Approval	CE
Weight	Modular type: ≈ 10 g, Singular type: ≈ 11 g



Ø 22 / 25 mm

Emergency Switches

S2ER Series



Features

- Smooth operation
- High electrical conductivity
- Long-lasting durability

Specifications

Series	S2ER Series
Actuation distance	5.0 to 5.5 mm
Actuation angle	40° ±7°
Actuation force	0.5 kgf (4.9 N) (per 1 contact)
Installation	Extended
Shock	300 m/s ² (≈ 30 G) in each X, Y, Z direction for 3 times
Shock (malfunction)	100 m/s ² (≈ 10 G) in each X, Y, Z direction for 3 times
Vibration	1.5 mm amplitude at frequency of 10 to 55 Hz (for 1 min) in each X, Y, Z direction for 2 hours
Vibration (malfunction)	1.5 mm amplitude at frequency of 10 to 55Hz (for 1 min) in each X, Y, Z direction for 10 minutes
Mechanical life cycle (control unit life cycle)	≥ 100,000 operations (20 operations/min)
Ambient temperature	-15 to 55 °C, storage : -25 to 65 °C (no freezing or condensation)
Ambient humidity	35 to 85 %RH, storage : 35 to 85 %RH (no freezing or condensation)
Protection structure	Control unit: IP52 (IEC standard)
Approval	CE ENEC EAC
Control unit weight	D30: ≈ 22.5 g D40: ≈ 22.5 g D60: ≈ 27 g
Housing weight	≈ 7 g
Contact blocks	
Power supply / current	110 VAC~ / 10 A, 250 VAC~ / 6 A
Dielectric strength	2,500 VAC~ 50/60 Hz for 1 minute
Insulation resistance	≥ 1,000 MΩ (500 VDC== megger)
Contact resistance	≤ 20 mΩ (initial)
Electrical life cycle	≥ 100,000 operations (20 operations/min)
Contact material	AgNi10
Approval	CE ENEC EAC
Weight	Modular type: ≈ 10 g, Singular type: ≈ 11 g
LED blocks	
Rated voltage	AC/DC voltage type: 12-24 VAC~ 50/60 Hz, 12-24 VDC== AC voltage type: 110-220 VAC~ 50/60 Hz
Current consumption	≤ 20 mA
Approval	CE ENEC EAC
Weight	AC/DC voltage type: ≈ 11 g, AC voltage type: ≈ 12 g

Ø 22 / 25 mm

Pilot Lights







L2RR Series



Features

- High luminance LED
- Available in various colors
- Long-lasting durability

Specifications

Series	L2RR Series
Installation	Extended
Shock	300 m/s ² (≈ 30 G) in each X, Y, Z direction for 3 times
Shock (malfunction)	100 m/s ² (≈ 10 G) in each X, Y, Z direction for 3 times
Vibration	1.5 mm amplitude at frequency of 10 to 55 Hz (for 1 min) in each X, Y, Z direction for 2 hours
Vibration (malfunction)	1.5 mm amplitude at frequency of 10 to 55 Hz (for 1 min) in each X, Y, Z direction for 10 minutes
Ambient temperature	-15 to 55 °C, storage : -25 to 65 °C (no freezing or condensation)
Ambient humidity	35 to 85 %RH, storage : 35 to 85 %RH (no freezing or condensation)
Protection structure	Light unit: IP52 (IEC standard)
Approval	CE    
Light unit weight	≈ 15.5 g
Housing weight	≈ 7 g
LED blocks	
Rated voltage	AC/DC voltage type: 12-24 VAC~ 50/60 Hz, 12-24 VDC= AC voltage type: 110-220 VAC~ 50/60 Hz
Current consumption	≤ 20 mA
Approval	CE   
Weight	AC/DC voltage type: ≈ 11 g, AC voltage type: ≈ 12 g

Ø 30 mm Push Button Switches

S3PR / S3PF Series



Features

- Smooth operation
- High electrical conductivity
- Long-lasting durability

Specifications

Series	S3PR Series	S3PF Series
Actuation distance	5.0 to 5.5 mm	
Actuation force	0.5 kgf (4.9 N) (per 1 contact)	
Installation	Extended	Flush
Shock	300 m/s ² (≈ 30 G) in each X, Y, Z direction for 3 times	
Shock (malfunction)	100 m/s ² (≈ 10 G) in each X, Y, Z direction for 3 times	
Vibration	1.5 mm amplitude at frequency of 10 to 55 Hz (for 1 min) in each X, Y, Z direction for 2 hours	
Vibration (malfunction)	1.5 mm amplitude at frequency of 10 to 55Hz (for 1 min) in each X, Y, Z direction for 10 minutes	
Mechanical life cycle (control unit life cycle)	Returned: ≥ 1 million operations (20 operations/min)	
Ambient temperature	-15 to 55 °C, storage : -25 to 65 °C (no freezing or condensation)	
Ambient humidity	35 to 85 %RH, storage : 35 to 85 %RH (no freezing or condensation)	
Protection structure	Control unit: IP52 (IEC standard)	
Approval	CE, RoHS, ENEC, EAC, CCC, PSE	
Control unit weight	21.5 g	
Housing weight	≈ 7 g	
Contact blocks		
Power supply / current	110 VAC~ / 10 A, 250 VAC~ / 6 A	
Dielectric strength	2,500 VAC~ 50/60 Hz for 1 minute	
Insulation resistance	≥ 1,000 MΩ (500 VDC== megger)	
Contact resistance	≤ 20 mΩ (initial)	
Electrical life cycle	≥ 100,000 operations (20 operations/min)	
Contact material	AgNi10	
Approval	CE, RoHS, ENEC, EAC, CCC, PSE	
Weight	Modular type: ≈ 10 g, Singular type: ≈ 11 g	
LED blocks		
Rated voltage	AC/DC voltage type: 12-24 VAC~ 50/60 Hz, 12-24 VDC== AC voltage type: 110-220 VAC~ 50/60 Hz	
Current consumption	≤ 20 mA	
Approval	CE, RoHS, ENEC, EAC	
Weight	AC/DC voltage type: ≈ 11 g, AC voltage type: ≈ 12 g	

Ø 30 mm

Selector Switches

S3SF Series



Features

- Smooth operation
- High electrical conductivity
- Long-lasting durability

Specifications

Series	S3SF Series
Actuation angle	2-position: [Spring return] 60° ±5°, 90° ±5° [Maintained] 90° ±5° 3-position: [Spring return] 60° ±5°, 45° ±5° [Maintained] 90° ±5°, 45° ±5°
Actuation force	0.5 kgf (4.9 N) (per 1 contact)
Installation	Flush
Shock	300 m/s ² (≈ 30 G) in each X, Y, Z direction for 3 times
Shock (malfunction)	100 m/s ² (≈ 10 G) in each X, Y, Z direction for 3 times
Vibration	1.5 mm amplitude at frequency of 10 to 55 Hz (for 1 min) in each X, Y, Z direction for 2 hours
Vibration (malfunction)	1.5 mm amplitude at frequency of 10 to 55Hz (for 1 min) in each X, Y, Z direction for 10 minutes
Mechanical life cycle (control unit life cycle)	≥ 100,000 operations (20 operations/min)
Ambient temperature	-15 to 55 °C, storage : -25 to 65 °C (no freezing or condensation)
Ambient humidity	35 to 85 %RH, storage : 35 to 85 %RH (no freezing or condensation)
Protection structure	Control unit: IP52 (IEC standard)
Approval	CE
Control unit weight	Standard head type: ≈ 23.5 g Shark-head type: ≈ 21 g
Housing weight	≈ 7 g
Contact blocks	
Power supply / current	110 VAC~ / 10 A, 250 VAC~ / 6 A
Dielectric strength	2,500 VAC~ 50/60 Hz for 1 minute
Insulation resistance	≥ 1,000 MΩ (500 VDC== megger)
Contact resistance	≤ 20 mΩ (initial)
Electrical life cycle	≥ 100,000 operations (20 operations/min)
Contact material	AgNi10
Approval	CE
Weight	Modular type: ≈ 10 g, Singular type: ≈ 11 g
LED blocks	
Rated voltage	AC/DC voltage type: 12-24 VAC~ 50/60 Hz, 12-24 VDC== AC voltage type: 110-220 VAC~ 50/60 Hz
Current consumption	≤ 20 mA
Approval	CE
Weight	AC/DC voltage type: ≈ 11 g, AC voltage type: ≈ 12 g



View product detail

Ø 30 mm Key Selector Switches

S3KF Series



Features

- Smooth operation
- High electrical conductivity
- Long-lasting durability

Specifications

Series	S3KF Series
Actuation angle	2-position: [Spring return] 60° ±5° [Maintained] 90° ±5° 3-position: [Spring return] 60° ±5° [Maintained] 90° ±5°
Actuation force	0.5 kgf (4.9 N) (per 1 contact)
Installation	Flush
Shock	300 m/s ² (≈ 30 G) in each X, Y, Z direction for 3 times
Shock (malfunction)	100 m/s ² (≈ 10 G) in each X, Y, Z direction for 3 times
Vibration	1.5 mm amplitude at frequency of 10 to 55 Hz (for 1 min) in each X, Y, Z direction for 2 hours
Vibration (malfunction)	1.5 mm amplitude at frequency of 10 to 55 Hz (for 1 min) in each X, Y, Z direction for 10 minutes
Mechanical life cycle (control unit life cycle)	≥ 100,000 operations (20 operations/min)
Ambient temperature	-15 to 55 °C, storage : -25 to 65 °C (no freezing or condensation)
Ambient humidity	35 to 85 %RH, storage : 35 to 85 %RH (no freezing or condensation)
Protection structure	Control unit: IP52 (IEC standard)
Approval	CE
Control unit weight	≈ 41 g
Housing weight	≈ 7 g
Contact blocks	
Power supply / current	110 VAC~ / 10 A, 250 VAC~ / 6 A
Dielectric strength	2,500 VAC~ 50/60 Hz for 1 minute
Insulation resistance	≥ 1,000 MΩ (500 VDC= megger)
Contact resistance	≤ 20 mΩ (initial)
Electrical life cycle	≥ 100,000 operations (20 operations/min)
Contact material	AgNi10
Approval	CE
Weight	Modular type: ≈ 10 g, Singular type: ≈ 11 g

Ø 30 mm Pilot Lights

L3RF Series



Features

- High luminance LED
- Available in various colors
- Long-lasting durability

Specifications

Series	L3RF Series
Installation	Flush
Shock	300 m/s ² (≈ 30 G) in each X, Y, Z direction for 3 times
Shock (malfunction)	100 m/s ² (≈ 10 G) in each X, Y, Z direction for 3 times
Vibration	1.5 mm amplitude at frequency of 10 to 55 Hz (for 1 min) in each X, Y, Z direction for 2 hours
Vibration (malfunction)	1.5 mm amplitude at frequency of 10 to 55 Hz (for 1 min) in each X, Y, Z direction for 10 minutes
Ambient temperature	-15 to 55 °C, storage : -25 to 65 °C (no freezing or condensation)
Ambient humidity	35 to 85 %RH, storage : 35 to 85 %RH (no freezing or condensation)
Protection structure	Light unit: IP52 (IEC standard)
Approval	CE e SA US ENEC
Light unit weight	≈ 22 g
Housing weight	≈ 7 g
LED blocks	
Rated voltage	AC/DC voltage type: 12-24 VAC~ 50/60 Hz, 12-24 VDC== AC voltage type: 110-220 VAC~ 50/60 Hz
Current consumption	≤ 20 mA
Approval	CE e SA US ENEC
Weight	AC/DC voltage type: ≈ 11 g, AC voltage type: ≈ 12 g

□ 30 mm Push Button Switches

SQ3PF Series



Features

- Smooth operation
- High electrical conductivity
- Long-lasting durability

Specifications

Series	SQ3PF Series
Actuation distance	5.0 to 5.5 mm
Actuation force	0.5 kgf (4.9 N) (per 1 contact)
Installation	Flush
Shock	300 m/s ² (≈ 30 G) in each X, Y, Z direction for 3 times
Shock (malfunction)	100 m/s ² (≈ 10 G) in each X, Y, Z direction for 3 times
Vibration	1.5 mm amplitude at frequency of 10 to 55 Hz (for 1 min) in each X, Y, Z direction for 2 hours
Vibration (malfunction)	1.5 mm amplitude at frequency of 10 to 55Hz (for 1 min) in each X, Y, Z direction for 10 minutes
Mechanical life cycle (control unit life cycle)	Returned: ≥ 1 million operations (20 operations/min)
Ambient temperature	-15 to 55 °C, storage : -25 to 65 °C (no freezing or condensation)
Ambient humidity	35 to 85 %RH, storage : 35 to 85 %RH (no freezing or condensation)
Protection structure	Control unit: IP52 (IEC standard)
Approval	CE
Control unit weight	≈ 22 g
Housing weight	≈ 7 g
Contact blocks	
Power supply / current	110 VAC~ / 10 A, 250 VAC~ / 6 A
Dielectric strength	2,500 VAC~ 50/60 Hz for 1 minute
Insulation resistance	≥ 1,000 MΩ (500 VDC== megger)
Contact resistance	≤ 20 mΩ (initial)
Electrical life cycle	≥ 100,000 operations (20 operations/min)
Contact material	AgNi10
Approval	CE
Weight	Modular type: ≈ 10 g, Singular type: ≈ 11 g
LED blocks	
Rated voltage	AC/DC voltage type: 12-24 VAC~ 50/60 Hz, 12-24 VDC== AC voltage type: 110-220 VAC~ 50/60 Hz
Current consumption	≤ 20 mA
Approval	CE
Weight	AC/DC voltage type: ≈ 11 g, AC voltage type: ≈ 12 g

□ 30mm Pilot Lights

LQ3RF Series



Features

- High luminance LED
- Available in various colors
- Long-lasting durability

Specifications

Series	LQ3RF Series
Installation	Flush
Shock	300 m/s ² (≈ 30 G) in each X, Y, Z direction for 3 times
Shock (malfunction)	100 m/s ² (≈ 10 G) in each X, Y, Z direction for 3 times
Vibration	1.5 mm amplitude at frequency of 10 to 55 Hz (for 1 min) in each X, Y, Z direction for 2 hours
Vibration (malfunction)	1.5 mm amplitude at frequency of 10 to 55 Hz (for 1 min) in each X, Y, Z direction for 10 minutes
Ambient temperature	-15 to 55 °C, storage : -25 to 65 °C (no freezing or condensation)
Ambient humidity	35 to 85 %RH, storage : 35 to 85 %RH (no freezing or condensation)
Protection structure	Light unit: IP52 (IEC standard)
Approval	CE e SA US ENEC
Light unit weight	≈ 22 g
Housing weight	≈ 7 g
LED blocks	
Rated voltage	AC/DC voltage type: 12-24 VAC~ 50/60 Hz, 12-24 VDC== AC voltage type: 110-220 VAC~ 50/60 Hz
Current consumption	≤ 20 mA
Approval	CE e SA US ENEC
Weight	AC/DC voltage type: ≈ 11 g, AC voltage type: ≈ 12 g

Magnetic Non-Contact Switches

MN Series



Features

- Non-powered magnetic detection method
- Two wiring specifications of cable / cable connector type
- Available to install at back-forth / right-left moving door
- IP67 protection structure (IEC standard)

Specifications

Model	MN-AB-□	MN-2A-□
Contact	1 × N.O. + 1 × N.C.	2 × N.O.
Operating distance ⁰¹⁾	OFF→ON	≥ 5 mm
	ON→OFF	≤ 15 mm
Approval	CE, RoHS, ENEC	
Unit weight (package)	Cable type: ≈ 92.6 g (≈ 106.5 g)	
	Cable connector type: ≈ 47.2g (≈ 61.0g)	
01) Rated at the ambient temperature of 23 °C. It can be differ up to ±20 % according to the ambient temperature.		
Switching voltage	≤ 24 VDC=	
Switching current	≤ 400 mA	
Life expectancy	≥ 1 billion times (with low load)	
Vibration	1.0 mm double amplitude at frequency of 10 to 55 Hz (for 1 minute) in each X, Y, Z direction for 2 hours	
Vibration (malfunction)	1.0 mm double amplitude at frequency of 10 to 55 Hz (for 1 minute) in each X, Y, Z direction for 10 minutes	
Shock	300 m/s ² (≈ 30 G) in each X, Y, Z direction for 3 times	
Shock (malfunction)	300m/s ² (≈ 30 G) in each X, Y, Z direction in output ON/OFF status for 3 times	
Ambient temperature	-10 to 55 °C, storage: -20 to 60 °C (a non freezing or condensation environment)	
Ambient humidity	35 to 85 %RH, storage : 35 to 85 %RH (a non freezing or condensation environment)	
Protection structure	IP67 (IEC standard)	
Connection	Cable type / Cable connector type	
Cable	∅ 5 mm, 4-wire cable type: 2 m, cable connector type: 0.3 m	
Wire	AWG24 (0.08 mm), 40-core, core diameter: ∅ 1.11 mm	
Connector	M12 connector	
Material	Body/CAP: PC	

[Applied REED SWITCH]

Model	ORD324-25-30 (STANDEX MEDER)
Contact	A (SPST-NO: single pole single throw, normally open)
Contact rating	≤ 10 W/VA ⁰¹⁾
Voltage	Switching: ≤ 200 VDC=, Breakdown: ≥ 250 VDC=
Current	Switching: ≤ 0.5 A, Carry: ≤ 1 A
Ambient temperature	-40 to 125 °C, storage : -65 to 125 °C ⁰²⁾
Material	Body: glass, leads: tin-plated Ni-Fe wire

01) Switching voltage and current should never exceed the wattage rating.

02) Long time exposure at elevated temperature may degrade solderability of the leads.

K. Signals

Signal lights are frequently used in industrial settings to offer audio status indication of control processes and applications.

K1. Buzzers







K1. Buzzers

The buzzer informs the situation by making a sound. There are magnetic buzzers and piezo buzzers depending on the structure that making a sound.

K1-1 Buzzers

B2PB Series

Piezo Buzzers

B6MA Series

Melody Buzzers

B2NB Series

Magnetic Buzzers

K

Piezo Buzzers

B2PB Series



Features

- Clear and loud sound:
up to 98 ± 8 dB (at 0.1 m)
- Select between continuous or intermittent sound settings
- Mounting hole: $\varnothing 22 / 25$ mm /
Panel thickness: 6 mm

Specifications

Model	B2PB-B1D	B2PB-B1D-R
Power supply	12-24 VDC \pm ± 10 %	
Power consumption	≤ 0.6 W	
Current consumption	≤ 25 mA	
Sound pressure	98 ± 8 dB (distance: 0.1 m) ⁰¹⁾	
Sound frequency	≈ 2.5 kHz	
Sound type ⁰²⁾	Continuous sound, intermittent sound	
Mounting hole	$\varnothing 22/25$ mm compatible	
Operation indicator	Green	Red
Insulation resistance	$\geq 1,000$ M Ω (500 VDC \Rightarrow megger)	
Dielectric strength	500 VAC \sim 50/60 Hz for 1 min (between all terminals and case)	
Vibration	0.75 mm amplitude at frequency of 10 to 55 Hz (for 1 min) in each X, Y, Z direction for 1 hour	
Vibration (malfunction)	0.75 mm amplitude at frequency of 10 to 55 Hz (for 1 min) in each X, Y, Z direction for 10 min	
Shock	500 m/s ² (≈ 50 G) in each X, Y, Z direction for 3 times	
Shock (malfunction)	147 m/s ² (≈ 15 G) in each X, Y, Z direction for 3 times	
Ambient temperature	-15 to 55 °C, storage: -25 to 65 °C (no freezing or condensation)	
Ambient humidity	35 to 85 %RH, storage: 35 to 85 %RH (no freezing or condensation)	
Protection structure	IP65 (front, IEC standard)	
Material	Cap: PC, Body: PA6 (G15%)	
Tightening torque	0.4 to 0.6 N m	
Approval	CE ENEC	
Unit weight (packaged)	≈ 18 g (≈ 305 g, 10 units)	

01) It is rated at power supply 24 VDC \Rightarrow . (sound pressure may be decreased when using 12 VDC \Rightarrow .)

02) Connect the power in the right direction: continuous sound (beep ---), Connect the power in the reverse direction: intermittent sound (beep- beep-)

Melody Buzzers

B6MA Series



Features

- 4 different melodies (ambulance, police siren, phone ring, Für Elise)
- Check operation status with operation indicator (red LED)
- End sleeves (ferrule terminal) provide simple wiring
- Power supply:
12 - 24 VDC, 110 - 220 VAC 50 / 60 Hz
- Max volume:
up to 95 dB (at 1 m), *105 dB (at 0.1 m)
- Installation diameter: Ø 66 mm
- Installation method: screw-on method
- IP65 protection structure (IEC standard, front-plate only)

Specifications

Model	B6MA-4GD□	B6MA-4GL□
Power supply	12 - 24 VDC==	110 - 220 VAC~ 50/60 Hz
Allowable voltage range	90 to 110% of power supply	
Power consumption	≤ 3 W	≤ 5 VA
Input	NPN open collector / PNP open collector model	
Sound pressure	Max. 105±10%dB (0.1 m), Max. 95±10%dB (1 m)	
Channels	4 channels	
Melody type	Terminal input: 4 types (ambulance, police, ringtone, for elise)	
Insulation resistance	≥ 1,000 MΩ (500VDC== megger, between all terminals and case)	
Dielectric strength	500 VAC~ 50/60 Hz for 1 min (between all terminals and case)	2,000 VAC~ 50/60 Hz for 1 min (between all terminals and case)
Vibration	0.75 mm amplitude at frequency of 10 to 55 Hz (for 1 min) in each X, Y, Z direction for 2 hours	
Shock	500 m/s ² (≈ 50 G) In each X, Y, Z direction for 3 times	
Ambient temperature	-10 to 55 °C, storage: -20 to 65 °C (no freezing or condensation)	
Ambient humidity	35 to 85 %RH, storage: 35 to 85 %RH (no freezing or condensation)	
Protection structure	IP65 (front, IEC standard)	
Material	PC	
Tightening torque for power input terminal	0.4 to 0.6 N m	
Tightening torque for nut on panel mounting	0.7 to 0.8 N m	
Accessories	Flat washers: 4, Spring washers: 4, Hex nuts: 4	
Approval	CE ENEC	
Unit weight (packaged)	≈ 130 g (≈ 170 g)	

Magnetic Buzzers

B2NB Series



Features

- Clear and loud sound :
up to 87 ± 10 dB (at 0.1 m)
- Select between continuous or intermittent sound settings
- Mounting hole: $\varnothing 22 / 25$ mm /
Panel thickness: 6 mm

Specifications

Model	B2NB-B1D	B2NB-B1D-R
Power supply	12 - 24 VDC \equiv	
Power consumption	≤ 1.5 W	
Sound pressure	$\approx 87 \pm 10$ dB (distance: 0.1 m) ⁰¹⁾	
Sound type	Continuous sound, intermittent sound ⁰²⁾	
Mounting hole	$\varnothing 22/25$ mm compatible	
Operation indicator	Green	Red
Insulation resistance	≥ 50 M Ω (500 VDC \equiv megger)	
Dielectric strength	1,000 VAC \sim 50/60 Hz for 1 minute (between all terminals and case)	
Vibration	0.75 mm amplitude at frequency of 10 to 55 Hz (for 1 min) in each X, Y, Z direction for 1 hour	
Shock	500 m/s ² (≈ 50 G) in each X, Y, Z direction for 3 times	
Ambient temperature	-15 to 55 °C, storage: -25 to 65 °C (no freezing or condensation)	
Ambient humidity	35 to 85 %RH, storage: 35 to 85 %RH (no freezing or condensation)	
Protection structure	IP30 (front)	
Material	Body: PA6, Cap: PC	
Tightening torque	0.4 to 0.6 N m	
Approval	CE ENEC	
Unit weight (packaged)	≈ 14 g (≈ 214 g) ⁰³⁾	

01) It is rated at power supply 24 VDC \equiv . (sound pressure may be decreased when using 12 VDC \equiv .)

02) Jumper pin attached: intermittent sound (beep - beep -), Jumper pin removed: continuous sound (beep ---)

03) It is weight per product. The weight in parentheses is for 10 packing units including packing materials.

L. Software

Autonics software allows users to configure parameters, monitor status, program control processes with various Autonics devices.

L1. Software





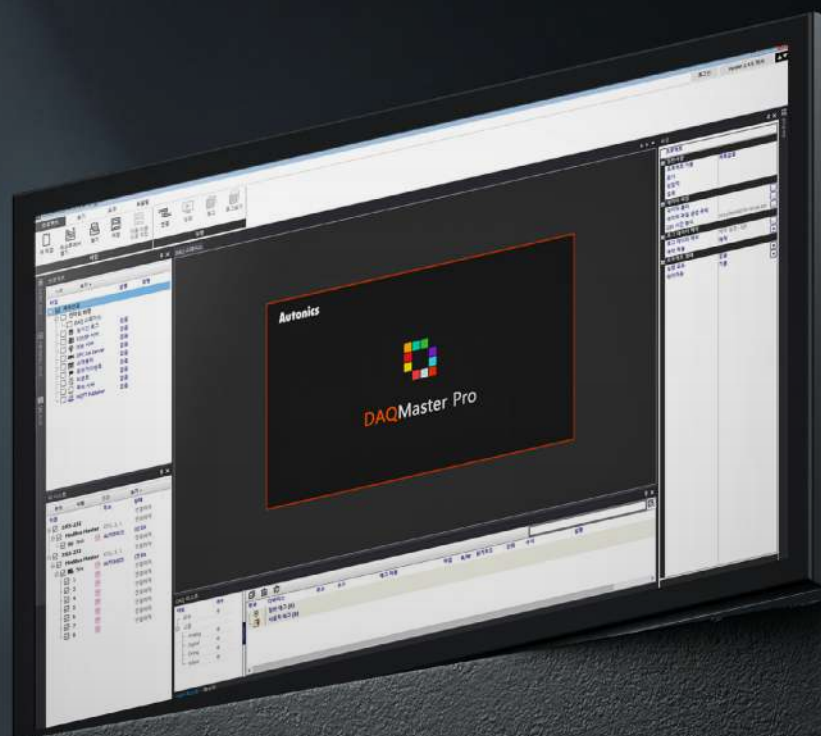

L1. Software

Autonics software allows users to configure parameters, monitor status, program control processes with various Autonics devices.

L1-1	Comprehensive Management	DAQMaster	Comprehensive Device Management Software
L1-2	Machine Vision	atVision	Vision Software (for VC Series)
		Vision Master	Vision Software (for VG Series)
L1-3	IO-Link	atIOLink	IO-Link Software
L1-4	Light Curtain	atLightCurtain	Safety Light Curtain Software
L1-5	LiDAR	atLiDAR	Laser Scanner Software
L1-6	Displacement	atDisplacement	Laser Displacement Sensors Software
L1-7	Motion Control	atMotion	Motion Control Software
L1-8	HMI	atLogic	HMI Logic Programming Software (for LP Series)
		atDesigner	HMI Screen Editor Software (for LP / GP Series)

Comprehensive Device Management Software

DAQMaster

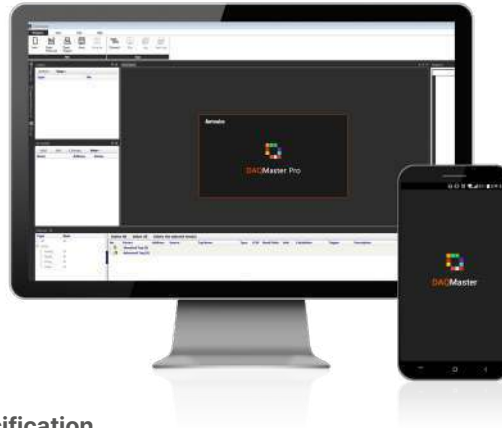

Features

[DAQMaster Standard / Pro Version Common Features]

- Multiple device support
- Scan for devices
- Simple graphic user interface
- Project management
- Data analysis using grids or graphs
- Log monitoring data
- Real-time Logging (CSV)
- Edit tag formulas
- Print Modbus Map Table report
- Lua script support
- Multi-language support (English, Korean, Japanese, Chinese-Simplified / Traditional)
- * DAQMaster Mobile is only available in English, Korean, and Chinese-Simplified / Traditional

[DAQMaster Pro Version Features]

- Modbus device editor
- Trigger event, scheduler
- Action (SMS, e-mail, etc.)
- Push server (Android, iOS support)
- Database management
- TCP / IP server
- OPC DA server / client
- OPC UA client
- MQTT (publisher, subscriber)
- DDE server / client
- Modbus master / slave
- Virtual tag (tag combination)
- Manage user privileges

Installation Specification

[DAQMaster / DAQMaster Pro]

Download the installation program from the Autonics website.

Item	Minimum requirements
System	IBM PC compatible computer with over 1 GHz processor
OS	Microsoft Windows 7 / 8.1 / 10
RAM	2 GB or higher
Storages	At least 1 GB of available HDD space
Resolution	1024 × 768 or higher
Others	RS232C Serial port (9-pin), USB port

[DAQMaster Mobile]

DAQMaster Mobile available for Android and iOS.

Android (Google Play): DAQMaster
iOS (App Store): DAQMaster

Item	Minimum requirements
Version	Android version 8.0 to 10.0, iOS 12.0 or higher
Rating	Rated for 3+
Permissions	Read/edit/delete files from storage All internet features when connected to Wi-Fi

Manual

Please refer to the manual for correct use of the product and be sure to follow the precautions. Download the manual from the Autonics website.

Supported Device

[Communication Supported Devices of Autonics]

Supported devices will be updated continuously. You can check the supported devices from the list of supported devices in the software.

For more information, refer to the manual of the supported device.

DAQMaster Features by Version

Version	DAQMaster	DAQMaster Pro	DAQMaster Mobile
Type	Free	Paid (License / USB dongle)	Free
O/S	PC		Mobile (Android: 8.0 and above / iOS: 12.0 and above)
Runtime screen	Panel (SVG) / Multi-Panel (Vector Font) / Grid / Line Graph / Bar Graph / Color Map Graph / Gauge Graph / Histogram Graph / Alarm History Grid		Panel (Vector Font) / Multi- Panel (Vector Font) / Grid / Line Graph / Bar Graph / Gauge Graph
Basic features	GUI / Data Monitoring / Set Parameters / Project Management / Multiple Device Support / Scan for Devices / Lua Script Support / Log Monitoring Data / Edit Tag Formulas / Print Modbus Map Table Report		GUI / Data Monitoring / Set Parameters / Project Management / Multiple Device Support / Scan for Devices / Lua Script Support
Data Analysis	[ddf] Grid / Graph / Alarm Spread / Analysis Spread [Database] Grid / Graph		-
Realtime Log	CSV	Refer to the Dedicated functions for DAQMaster Pro	-
Protocol	[Modbus Master] RTU / TCP / ASCII		
Multi-Language Support	Korean / English / Chinese (Simplified, Traditional) / Japanese		Korean / English / Chinese (Simplified, Traditional)

Dedicated Functions for DAQMaster Pro

Function	Details	
Utility (Tool)	Modbus Device Editor / Script Editor	
Expansion Features	Scheduler / Trigger Event / Virtual Tag (Tag Combination) / Manage User Privileges	
Action	Log Start / Log Stop / Send to Telegram / Play Alarm Sound / Tag Error Message / Tag Alarm / Tag Output / SFTP / Print Report / SMS / E-Mail	
Realtime Log	CSV	
Log	SQL	Oracle / SQL Server / MySQL / DB2 / SQLite / PostgreSQL / InterBase / Nexus DB / Firebird / Sybase ASE / Sybase ADS / MS Access / DBF / Advantage
	NoSQL	Mongo DB
Protocol	TCP/IP Server	Monitoring / Security (Login) / Read Tag / Write Tag
	OPC DA	1.0 (Format) / 2.0 (Format) / 3.0 (Format) / Client
	OPC AE	1.0 (Format) / 1.10(Format) / Client
	OPC UA	TCP (Format) / HTTP (Format) / HTTPS(Format) / Client
	DDE	CF_Text (Format) / XL_Table (Format) / Server / Client
	WMI Manager	Supported
	Push Server	Supported Android / iOS
	Database Middleware Server	Supported
	MQTT	Publisher / Subscriber
	Fieldbus Master	CC-Link IE Field Basic
	Modbus Master	RTU / TCP / ASCII
	Modbus Slave	RTU / TCP / ASCII

Dedicated functions for DAQMaster Mobile

Function	Details
DAQMaster Client Function	Monitoring, Read/Write Parameters ⁰¹⁾
Read All Parameters for Registered Devices	Supported
Horizontal Screen Support	Supported
Backup/Restore Project Files	Google Drive
DAQMaster Push Alarm Function	Android / iOS ⁰¹⁾

01) Supported for DAQMaster Pro v3.4 over

Vision

Software

(for VC Series)

atVision



Features

- Various inspection functions
- With 64 work group settings (32 inspection points per group), flexible coping with changes in work environment is possible
- Work group management and parameter setting
- Inspection result monitoring and output data setting
- Transfer the test result image to FTP server

Installation Specification

Download the installation program from the Autonics website.

Item	Minimum requirements
CPU	Intel i3, Ryzen 3 or above
OS	Microsoft Windows 7 (×64) or higher
RAM	6 GB or higher
Storage ⁰¹⁾	At least 10 GB of available HDD space
Resolution ⁰²⁾	1280 × 800 or higher (1920 × 1080 recommended)
Others	RJ45 Ethernet port, GigE network interface card

01) Additional HDD space may be required depending on the number of inspections.
02) This software is optimized for 1920 × 1080 resolution and 100% magnification.

Manual

Please refer to the manual for correct use of the product and be sure to follow the precautions. Download the manual from the Autonics website.

Supported Device

[Smart Camera VC Series]

For more information, refer to the manual of the supported device.

Inspection function

Function	Descriptions
Alignment	Calibrates position and rotation based on selected object.
Bar Code	Read bar code.
Matrix	Read data matrix code.
QR Code	Read QR code.
Extract Text	Separate text from background.
Read Text	Read separated text from background.
Area	Inspect the object area.
Angle	Inspect the angle between two edges.
Brightness	Inspect the object average brightness.
Contrast	Inspect the object average contrast.
Diameter	Inspect the diameter of the circle.
Length	Inspect the distance between two edges.
Edge	Inspect the existence of edges.
Object Counting	Inspect the object count.
Golden Template	Inspect the edge loss rate.
Pattern Multi (Edge)	Inspect the multi pattern with object edge pattern.
Pattern Single (Edge)	Inspect the single pattern with object edge pattern.
Pattern Multi (NCC)	Inspect the multi pattern with object pixel pattern.
Pattern Single (NCC)	Inspect the single pattern with object pixel pattern.

Vision

Software

(for VG Series)

Vision Master

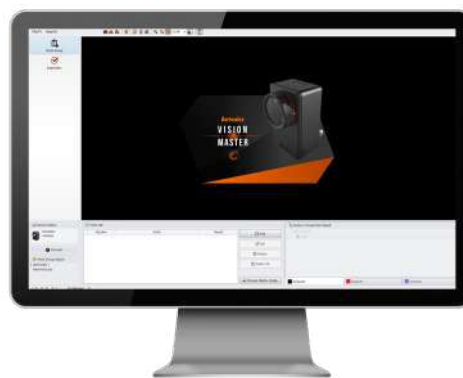

Features

- Various inspection functions
- Set up to 32 separate workgroups
- Manage parameters and workgroups
- Inspection results monitoring
- Inspection simulator function
- Send saved image data to FTP servers

Installation Specification

Download the installation program from the Autonics website.

Item	Minimum requirements
System	1 GHz or higher 32 bit (x86) or 64 bit (x64) processor
OS	Microsoft Windows 7 / 8 / 10
RAM	1 GB +
Storages	400 MB + of available HDD space
Resolution	1024 × 768 or higher
Others	RJ45 Ethernet port

Manual

Please refer to the manual for correct use of the product and be sure to follow the precautions. Download the manual from the Autonics website.

Supported Device

[Ethernet VGA Mono / Color Camera VG Series]

For more information, refer to the manual of the supported device.

Inspection function

The supported functions are varied by the image element of VG.

Function	Description
Alignment	To align position and orientation of the target based on the registered target
Brightness	To inspect average brightness of the target
Contrast	To inspect average contrast of the target
Area	To inspect area of the target
Shape comparison	To inspect shape of the target
Edge	To inspect the presence of the edge
Length	To inspect the length between two edges
Angle	To inspect the angle between two edges
Diameter	To inspect diameter of the circle
Object counting	To count the number of the object
Color identification	To inspect average color of the object
Area of color	To inspect area in a certain color
Object of color counting	To count the number of objects in a certain color

IO-Link Software

atIOLink



Features

- Configuration of the ports on IO-Link Master
- Parameter setting of IO-Link device
- Real-time monitoring of IO-Link device
- Monitoring and controlling input / output process data of IO-Link device
- Simplified maintenance and repair of IO-Link device
 - : supports data storage
 - : supports restore to factory settings

Installation Specification

Download the installation program from the Autonics website.

Item	Minimum requirements
CPU	Intel i3, Ryzen 3 or above
OS	Windows 7 (×64) or higher
RAM	6 GB or higher
Storages	At least 10 GB of available HDD space
Resolution	1280 × 800 or higher (1920 × 1080 recommended)
Others	RJ45 Ethernet port, GigE network interface card

Manual

Please refer to the manual for correct use of the product and be sure to follow the precautions. Download the manual from the Autonics website

Supported Device

[Supported IO-Link devices of Autonics]

Supported devices will be updated continuously. For more information, refer to the manual of the supported device.

[Iodd (IO Device Description)]

This file contains information such as manufacturer information, process data, diagnostic data, and parameter setting of a device using IO-Link communication. By uploading the Iodd file to PDCT Software, you can check the setting and communication data according to the user interface. Download the Iodd file from a manufacturer's website.

Safety Light Curtain Software

atLightCurtain



Features

- Intuitive graphic user interface
- Light curtain operation status monitoring
 - Monitor amount of light received
 - Monitor connection and switches
 - Monitor errors and warnings
- Supports safe distance calculation function

Installation Specification

Download the installation program from the Autonics website.

Item	Minimum requirements
System	IBM PC compatible computer with over 1 GHz processor
OS	Microsoft Windows 7
RAM	2 GB or higher
Storages	At least 1 GB of available HDD space
Resolution	1024 × 760 or higher
Others	USB port

Manual

Please refer to the manual for correct use of the product and be sure to follow the precautions. Download the manual from the Autonics website.

Supported Device

[Safety Cat. 4, Finger / Hand / Body Detection Safety Light Curtains SFL / SFLA Series]

For more information, refer to the manual of the supported device.

In case of SFL (Standard type), only monitoring function is supported, and in case of SFLA (advanced type), all functions such as parameter setting are available.

Laser Scanner Software

atLiDAR

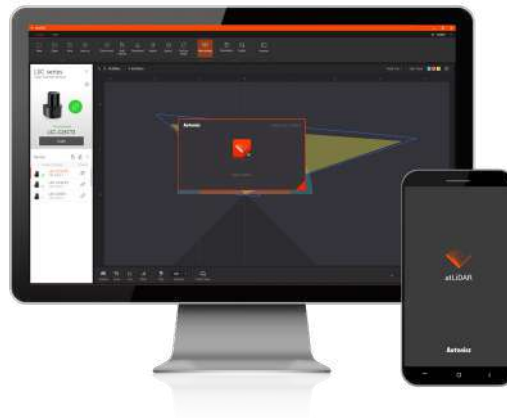

Features

- Intuitive UI design
 - Parameter setting
 - Field setting related to input / output, filter, and teaching function
 - The various detection ranges such as rectangle, circle, polygon and teaching function are available for setting the surrounding environment.
 - Data log monitoring
 - Data analysis
 - Mobile application support (Android)
 - Multi-language support (Korean, English)
- * Supported device functions for each version are different.

Installation Specification

Download the installation program from the Autonics website.

[atLiDAR (PC)]

Item	Minimum requirements
System	IBM PC compatible computer with over 1 GHz processor
OS	Windows 7 or later
RAM	2 GB or more
Storage	1 GB or more of free hard disk space
Resolution	<ul style="list-style-type: none"> • V1.1: 800 × 600 or higher (recommended: 1920 × 1080) • V2.0 or higher: 1280 × 800 or higher (recommended: 1920 × 1080)

[atLiDAR (Mobile)]

Search as below to download at operation system.

Android (Google Play Store): atLiDAR

Item	Minimum requirements
Version	Android 6.0 to 10.0
Rating	Rated for 3+
Permissions	Read / edit / delete files from storage

Manual

Please refer to the manual for correct use of the product and be sure to follow the precautions. Download the manual from the Autonics website.

Supported Device

atLiDAR (PC / mobile) is a management program for our LiDAR sensors. Supported devices will be updated continuously.

For more information, refer to the manual of the supported device.

Version	Device	LSE Series	LSC Series
Mobile	-	-	○
PC, V1.1	○	-	-
PC, V2.0	-	-	○

Laser Displacement Sensors Software

atDisplacement



Features

- Dedicated software for use with BD-C series: Graphic user interface, parameter settings and data monitoring of BD amplifier units
- Check profiles of connected devices through status window
- Monitor real-time data, graph, and wave pattern graphs

Installation Specification

Download the installation program from the Autonics website.

Item	Minimum requirements
System	IBM PC compatible computer with over 1 GHz processor
OS	Microsoft Windows 7 or higher
RAM	2 GB or higher
Storages	At least 1 GB of available HDD space
Resolution	1280 × 800 or higher
Others	RS232C Serial port (9-pin), USB port

Manual

Please refer to the manual for correct use of the product and be sure to follow the precautions. Download the manual from the Autonics website.

Supported Device

[Communication Converter for Laser Displacement Sensors BD-C Series]

For more information, refer to the manual of the supported device.

Motion Control Software

atMotion



Features

- Supports Multiple Devices
 - Monitor operation status of multiple devices and set parameters for each device
 - When multiple units with different addresses are connected, the address scan function provides
- Simple Graphic User Interface
 - Freely edit screen data to set parameters, monitor devices, and program control
 - Monitor operation status and history using DAQ Space (Line Graph, Grid)
- Multilingual Support
 - English and Korean are supported by default, and users can easily add other languages

Installation Specification

Download the installation program from the Autonics website.

Item	Minimum requirements
System	IBM PC compatible computer with over Pentium III
OS	Microsoft Windows 98 / NT / XP / Vista / 7 / 8 / 10
RAM	256 MB or higher
Storages	At least 1 GB of available HDD space
Resolution	1024 × 768 or higher
Others	RS232C Serial port (9 - pin), USB port

Manual

Please refer to the manual for correct use of the product and be sure to follow the precautions. Download the manual from the Autonics website.

Supported Device

[Motion Controller Devices of Autonics]

Supported devices will be updated continuously. You can check the supported devices from the list of supported devices in the software. For more information, refer to the manual of the supported device.

HMI Logic Programming Software

(for LP Series)

atLogic

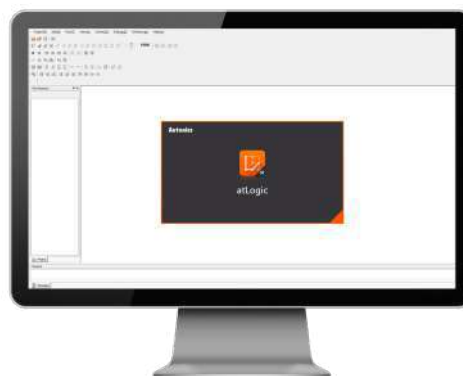

Features

- Supports multiple projects
 - Open up to 5 projects to create or edit programs simultaneously
- Convenient program editing
 - 1) Cell unit block editing
 - 2) Multi-window editing
 - 3) Easy editing with view variables, view description and view variables / description
 - 4) Simultaneous editing of ladder program and mnemonic program
- Various monitoring functions
 - Variable monitoring, device monitoring, system device monitoring, etc.
- Convenient user interface
 - Microsoft Windows based interface
- Real-time switching between ladder and mnemonic program
 - Simultaneous editing of ladder program and mnemonic program with real-time switching

Installation Specification

Download the installation program from the Autonics website.

Item	Recommended requirements
System	Pentium Dual Core
OS	Microsoft Windows 7 / 8.1 / 10
RAM	1 GB or higher
Storage	At least 5 GB of available HDD space
Resolution	1280 × 1024 or higher
Others	RS232C Serial port (9-pin), USB port, Ethernet

Manual

Please refer to the manual for correct use of the product and be sure to follow the precautions. Download the manual from the Autonics website.

Supported Device

[Color LCD Logic Panels LP-A Series]

For more information, refer to the manual of the supported device.

HMI Screen Editor

Software

(for LP / GP Series)

atDesigner

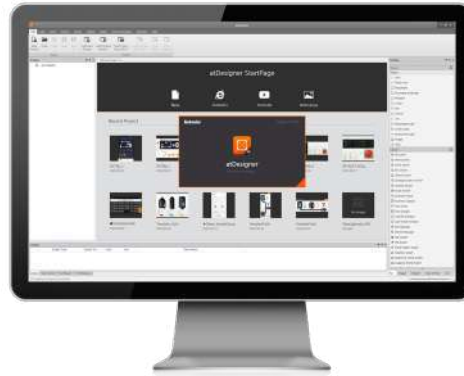

Features

- Convenient user interface
 - Supports Windows TrueType fonts and various bitmap fonts
 - GP / LP hardware firmware upgrades
 - Project conversion feature
 - Easily convert LP/GP-S series projects to LP / GP-A series projects
 - Diverse image library provided
 - images / screen / keypad
 - Overlap screen for improved screen editing efficiency and data size efficiency
 - Checks for screen project and data validity executed automatically after download to GP / LP devices.
 - Project simulator
 - Test edited projects using the project simulator function
- * Please use the GP Editor software for editing screens on LP-S070, LP-S044, GP-S070, GPS057, GP-S044 series

Installation Specification

Download the installation program from the Autonics website.

Item	Recommended requirements
System	Intel Core i5-2nd gen. 2500 or above
OS	Microsoft Windows 7 / 10
RAM	8 GB or higher
Storage	At least 8 GB of available HDD space
Resolution	1920 × 1080 or higher
Others	RS232C Serial port (9-pin), USB port, Ethernet

Manual

Please refer to the manual for correct use of the product and be sure to follow the precautions. Download the manual from the Autonics website.

Supported Device

[Color LCD Graphic Panels GP-A Series]

For more information, refer to the manual of the supported device.

[Color LCD Logic Panels LP-A Series]

For more information, refer to the manual of the supported device.

Autonics sensor controller switch motor connector models

02K-S523W	BC15-LDT-C	BM1M-MDT	BS3-K1M	BX15M-TDT
A140K-G599-G5	BD-030	BM200-DDT	BS4-K2R	BX15M-TFR
A140K-M599-G5	BD-065	BM3M-TDT	BS4-Y2R	BX15M-TFR-T
A140K-M599W-G5	BD-100	BMS2M-MDT-P	BS5-K1M	BX3M-PDT-T
A16K-G268	BD-A1	BMS2M-MDT	BS5-K2M	BX5M-MDT
A16K-M569	BD-CRS	BMS300-DDT-P	BS5-K2M-P	BX5M-MFR
A16K-M569-B	BEN10M-TDT	BMS300-DDT	BS5-L1M	BX5M-MFR-T
A16K-M569W	BEN10M-TFR	BMS5M-TDT	BS5-L1M-P	BX700-DDT
A1K-S543W-S	BEN300-DDT	BMS5M-TDT-P	BS5-L2M	BX700-DDT-T
A200K-M599-G7.2	BEN300-DFR	BPS3M-TDT	BS5-L2M G	BX700-DFR
A21K-M596	BEN3M-PDT	BPS3M-TDTL	BS5-P1MD	BX700-DFR-T
A2K-S544	BEN3M-PFR	BPS3M-TDT-P	BS5-T1M	BY500-TDT
A3K-S545	BEN500-DDT	BR100-DDT	BS5-T1M-P	BY500-TDT1,2
A3K-S545W	BEN500-DFR	BR100-DDT-P	BS5-T1R	BYD100-DDT
A41K-M599	BEN5M-MDT	BR200-DDTN	BS5-T2M	BYD30-DDT
A41K-M599-B	BEN5M-MFR	BR20M-TDTD	BS5-V1M	BYD30-DDT-U
A4K-M245	BF3RX	BR20M-TDTD-P	BS5-Y1M	BYD3M-TDT
A4K-M564	BF3RXB-D	BR20M-TDTL	BS5-Y1R-P	BYD3M-TDT-P
A50K-M566-GB10	BF3RXB-LP	BR20M-TDTL-P	BS5-Y2M	BYD50-DDT
A63K-M5913	BF3RX-P	BR3M-MDT	BS5-Y2M-P	BYD50-DDT-T
A63K-M5913-B	BF4G	BR3M-MDT	BTF15-BDTL	BYS500-TDT
A8K-M566	BF4R	BR3M-MDT-P	BTF1M-TDTD-P	BYS500-TDT1,2
A8K-M566-B	BF4R-E	BR400-DDT	BTF1M-TDTL	BYS-Y2M-P
A8K-M566W	BF4RP	BR400-DDT-P	BTF30-DDTL	C1DH4-1
A8K-M566W-S	BF4RP	BR4M-TDTD	BTS1M-TDTD	CID-10-VG
A8K-M566-Y	BF4R-R	BR4M-TDTD-P	BTS200-MDTD	CID2-2
A8K-S566-S	BF5R-D1-N	BRE5M-TDTD	BTS200-MDTD-P	CID2-5
ABS-S04PA-CN	BF5R-D1-P	BRE5M-TDTL	BTS200-MDTL	CID-2-VG
ADS-AF	BF5R-S1-N	BRP100-DDT	BTS200-MDTL-P	CID3-10
ADS-SE2	BFX-D1-N	BRP100-DDT-P	BTS30-LDTL	CID3-2
ADS-SH	BFX-D1-P	BRP200-DDTN	BUD-30	CID3-5
AH16K-M569	BH1M-DDT	BRP3M-MDT	BUP-30-P	CID3-5 G
AH63K-G5913	BH20M-TDT	BRP3M-MDT-P	BUP-30S	CID408-2
AiS-60LA	BH4M-PDT	BRP400-DDT	BUP-30S-P	CID408-5
ARM-DI08N-4S	BJ100-DDT	BRP400-DDT-P	BUP-50	CID4-10R
ARM-DO08P-4S	BJ100-DDT-C-P	BRQM100-DDTA	BUP-50-HD	CID4-10T
ARX-DI08N-4S	BJ100-DDT-P	BRQM100-DDTA-C	BUP-50-P	CID4-3R
ARX-DI08P-4S	BJ10M-TDT	BRQM100-DDTA-C-P	BUP-50S	CID4-3T
ARX-DO08N-4S	BJ10M-TDT-P	BRQM100-DDTA-P	BUP-50S-P	CID4-5R
ARX-DO08P-4S	BJ15M-TDT	BRQM1M-DDTA	BW20-08	CID4-5T
AS80-50DN3	BJ15M-TDT-C	BRQM1M-DDTA-P	BW20-08P	CID4-7R (灰色)
AS80-50DP3	BJ15M-TDT-P	BRQM20M-TDTA	BW20-12	CID-5-VG
AT11DN	BJ1M-DDT	BRQM20M-TDTA-P	BW20-16	CID9S-10
AT11DN-1	BJ1M-DDT-P	BRQM30M-TDTA	BW20-16P	CIDH4-3
AT11EN	BJ300-DDT	BRQM30M-TDTA-C	BW20-20	CIDH4-5
AT11EN-2	BJ300-DDT-P	BRQM3M-PDTA	BW20-20P	CIDH4-7
AT8N	BJ30-BDT	BRQM3M-PDTA-C	BW20-24	CIR-10-VG
AT8N-1	BJ3M-PDT	BRQM3M-PDTA-C-P	BW20-24P	CIR-2-VG
AT8N-2	BJ3M-PDT-C	BRQM3M-PDTA-P	BW20-28	CIR-5-VG
AT8PMN, AC100-120V	BJ3M-PDT-P	BRQM400-DDTA	BW20-32	CLD2-2
AT8PMN-2	BJ50-BDT	BRQM400-DDTA-C	BW20-32P	CLD2-5
AT8PSN	BJ50-BDT-P	BRQM400-DDTA-C-P	BW20-40	CLD3-10
AT8SDN	BJ7M-TDT	BRQM400-DDTA-P	BW20-48	CLD3-2
ATE1-3M AC220	BJ7M-TDT-P	BRQM5M-TDTA	BW20-48P	CLD3-5
ATE1-60S AC220	BJN100-NDT	BRQM5M-TDTA-C-P	BW40-04	CLDH4-10
ATE8-41	BJN100-NDT-P	BRQM5M-TDTA-P	BW40-06	CLDH4-3
ATE8-43	BJN50-NDT	BRQP100-DDTA	BW40-06 G	CLDH4-5
ATE8-46	BJN50-NDT-P	BRQP100-DDTA-P	BW40-06P	CLDH4-7
ATM4-210M	BJP100-BDT	BRQP100-DDTB	BW40-10	CN-6100-C1
ATS11W-41	BJR1M-DDT-F	BRQP1M-DDTA	BW40-10P	CN-6100-C2
ATS11W-41	BJX10M-TDT-P	BRQP1M-DDTB	BW40-12	CN-6100-V1
ATS8-41 ATS8	BJX1M-DDT	BRQP1M-DDTB-P	BW40-16P	CNE-B203
ATS8-43	BJX30M-TDT	BRQP3M-PDTA	BW40-18	CNE-BO3
ATS8P-5M ATS8P	BJX3M-PDT	BRQP3M-PDTA-P	BW40-18P	CNE-BO4
ATS8W-41 ATS8W	BJX3M-PDT-P	BRQP3M-PDTB	BW40-20	CNE-P03-BL
ATS8W-43	BK-BL13-P	BRQP3M-PDTB-P	BW40-20P	CNE-P03-GN
B2NB-BID-R	BK-SFL-SF	BRQP400-DDTA	BW40-24	CNE-P03-GY
BA2M-DDT	BL13-TDT	BRQP400-DDTA-C-P	BW40-24P	CNE-P03-OG
BA2M-DDT-P		BRQP400-DDTA-P	BWC40-18HD	CNE-P03-RE
BA2M-H8DDT		BRQP400-DDTB-P	BWC80-14HD	CNE-P03-WT
		BRQPS10M-TDTA	BWP20-08	CNE-P03-YW
		BRQPS20M-TDTA	BWP20-08P	CNE-P04-BL
		BRQPS400-DDTA	BWP20-08P	CNE-P04-OG
		BRQPS700-DDTA	BWP20-12	CNE-P04-WT
		BRQT400-DDTA	BWP20-12P	CNE-P04-YW
		BRQT400-DDTA-P	BWP20-16	
			BWP20-20	
			BWP20-20P	
			BWPK25-05	
			BWPK25-05R	

CNE-S03-BL	6BG%3Z S D	E40H8-150-3-T-24	E50S8-1024-3-T-24	EXT-SFL
CNE-S03-GN	6BG%3Z & @	E40H8-1800-3-T-24	E50S8-1024-6-L-24	EXT-US
CNE-S03-GY	6BG%3Z ' " D	E40H8-200-6-L-5	E50S8-120-3-N-24	FD-320-05
CNE-S03-OG	6BG%4Z# " D	E40H8-2500-3-T-24	E50S8-120-3-T-24	FD-320-F1
CNE-S03-RE	6BG%4Z#S " @	E40H8-3600-3-N-24	E50S8-2000-3-N-24	FD-420-05
CNE-S03-WT	6BG%4Z#S " D	E40H8-3600-3-T-24	E50S8-2000-3-T-24	FD-420-05R
CNE-S03-YW	6BG%4Z# " @	E40H8-3600-3-V-5	E50S8-200-3-T-24	FD-620-10
CNE-S04-BL	6BG%4Z# " D	E40H8-3600-6-L-5	E50S8-200-3-T-24	FD-620-13B
CNE-S04-GN	6BG%4Z# " D	E40H8-360-3-N-24	E50S8-20-3-T-24	FD-620-15H1
CNE-S04-GY	6BG%4Z# " 6	E40H8-5000-6-L-5	E50S8-2048-3-T-24	FD-620-F2
CNE-S04-OG	6BG%4ZS " " @	E40H8-500-3-T-24	E50S8-2048-3-T-24	FDC-320-05
COUPLING4	6BG%4ZS " " D	E40H8-500-6-L-5	E50S8-2500-3-T-24	FDCS-320-05
COUPLING4	6BG%5ZS " " 6	E40H8-600-3-N-24	E50S8-2500-6-L-5	FDP-320-10
CR18-8AC	6BG%5ZS " 6	E40H8-800-6-L-5	E50S8-300-3-T-24	FDR-610-10R
CR18-8AO	6BG%5ZS " @	E40HB12-2500-6-L-5	E50S8-3600-3-N-24	FDS-620-10
CR18-8DN	6BG%5ZS " D	E40HB6-600-3-T-24	E50S8-3600-3-T-24	FS4-1P4
CR18-8DN2	6BG%5Z% " 6	E40HB8-2000-6-L-5	E50S8-3600-3-V-5	FS4A, DC
CR18-8DP	6BG%5Z% " @	E40HB8-2048-6-L-5	E50S8-3600-6-L-5	FS4E, AC
CR30-15AC	6BG%5Z% " D	E40HB8-2500-3-N-24	E50S8-3600-6-L-5	FS4E-1P4
CR30-15AO	6BG%6Z% " D	E40HB8-5000-3-T-24	E50S8-360-3-N-24	FT-320-05
CR30-15DN	6BG%6Z " " D	E40HB8-500-3-N-24	E50S8-360-3-T-24	FT-420-10
CR30-15DN2	6BG%84Z * " D	E40HB8-500-3-N-5	E50S8-360-6-L-24	FT-420-10R
CR30-15DP	6BG%84ZS " " @	E40S6-1000-3-N-24	E50S8-360-6-L-5-CS	FTC-220-05
CT-01	6BG%85ZS " @	E40S6-1000-3-T-24	E50S8-5000-3-T-24	FTC-320-10
CT-02	6E# ZDE	E40S6-1000-3-T-5	E50S8-5000-6-L-5	FTR-410-10R
CT-02 1M	6ESSZDB	E40S6-1000-6-L-5	E50S8-500-3-T-24	FTS-420-10
CT-10S	7# " : % Z# S&Z&F Z&S&	E40S6-100-3-N-5	E50S8-500-6-L-5	FTW11-210-10R
CT4S-1P2 CT4S	7# ESZ% ZS&@Z ZD	E40S6-100-3-T-24	E50S8-50-3-T-24	FTW11-210-10R
CT4S-1P4	7% EXZ# " " Z&F Z&S&	E40S6-1024-3-N-24	E50S8-50-6-L-5	FX4M-1P4 FX4M
CT4S-2P2	7% EXZ# " Z&F Z&S&	E40S6-1024-3-T-24	E50S8-600-3-N-24	FX4M-2P4
CT4S-2P4	7% EXZ# S&Z&F Z&S&	E40S6-1024-6-L-24	E50S8-600-3-T-24	FX4S, AC
CT4S-2P4T	7% EXZS " Z&@Z&S&	E40S6-1024-6-L-5	E50S8-600-3-T-5	FX4S-1P2
CT6M-1P2 CT6M	7% EXZ% " " Z&@Z&S&	E40S6-1200-3-T-24	E50S8-8000-6-L-5	FX4S-1P4
CT6M-1P4	7& : # Z# " Z&@Z&S&	E40S6-1500-3-T-24	E50S8-8000-6-L-5-C	FX4Y-I2 FX4Y
CT6M-2P2	7& : # Z# " Z&@Z&S&	E40S6-2000-6-L-24	E50S8-800-3-T-24	FX6M-1P4 FX6M
CT6M-2P2T	7& : # Z# S&Z&@Z&S&	E40S6-2000-6-L-5	E58H12-500-3-T-5	FX6Y-I, DC
CT6M-2P4	7& : # Z# S&Z&F Z&S&	E40S6-200-3-N-24	E58H12-500-3-T-5	FX6Y-I4 FX6Y
CT6M-2P4T	7& : # Z# S&Z Z&Z	E40S6-200-3-N-5	E58SC10-1000-3-T-24	GUARD-SF2ER
CT6M-I2	7& : # ZS " " Z&Z	E40S6-200-3-T-24	E58SC10-1024-3-T-24-C	KN-1000B
CT6M-I2T	7& : # ZS " " Z&@Z&S&	E40S6-2500-3-N-24	E58SC10-2500-3-T-24	KN-1001B
CT6M-I4T	7& : # ZS " " Z&Z	E40S6-2500-3-T-24	E58SS6-2500-6-L-5	KN-1200B
CT6S, DC CT6S	7& : # Z " " Z&Z	E40S6-2500-3-T-5	E60H20-5000-6-L-5 G	KN-1400B
CT6S-1P2	7& : # SZ# " " Z&F Z&S&	E40S6-2500-6-L-5	E68S15-1024-6-L-5	KN-1401B
CT6S-1P2T	7& : # SZ# " Z&@Z&S&	E40S6-250-6-L-5	E80H30-1024-6-L-5	KN-2000W
CT6S-1P4	7& : # SZ# S&Z&@Z&S&	E40S6-30-3-T-24	E80H30-1024-3-T-24	KN-2200W
CT6S-1P4T	7& : # SZ# S&Z&F Z&S&	E40S6-300-3-N-24	E80H30-3200-3-T-24	KN-2210W
CT6S-2P2	7& : # SZ# S&Z&F Z&S&	E40S6-3600-3-T-24	E80H30-500-3-T-24	KN-2211W
CT6S-2P4	7& : # SZ#S " Z&F Z&S&	E40S6-3600-3-V-5	ENA-200-3-T-24	KN-2250W
CT6S-2P4T	7& : # SZS " " Z&F Z&S&	E40S6-3600-6-L-5	ENC-1-1-N-24	KN-2400W
CT6S-I2T	7& : # SZS " " Z&@Z&S&	E40S6-360-3-N-24	ENC-1-1-T-24	KN-2450W
CT6S-I4	7& : # SZS " " Z&@Z&S&	E40S6-360-3-T-24	ENC-1-2-T-24	KPN5300-000
CT6Y-1P2T	7& : # SZS " " Z&Z	E40S6-360-3-T-24 G	ENC-1-3-N-24	KPN5500-000
CT6Y-1P4 CT6Y	7& : # SZ% " " Z&Z&S&	E40S6-5000-3-N-24	ENC-1-3-T-24	KRN100 PAPER
CT6Y-2P4	7& : # SZ% " " Z&Z&S&Z	E40S6-5000-3-N-5	ENH-100-1-T-24	KRN100-12000-00-0S
CT6Y-I4	7& : # SZ% " " Z&Z	E40S6-5000-3-T-24	ENH-100-2-T-24	KT-302HS-0500
CX6S-1P4 CX6S	7& : # SZ% " " Z&Z&Z	E40S6-5000-6-L-5	ENH-100-2-V-5	KT-302HS-0510
D1AA-RN	7& : # SZ " " " Z&@Z	E40S6-500-6-L-24	ENP-111F-008-P	KT-302HS-S-05-1-1
D1SA-RN	7& : # SZ " " " Z&Z	E40S6-50-3-N-24	ENP-111R-024-P	KT-302HS-0710
D1SC-N	7& : # SZ " " " Z&@Z&S&	E40S6-600-3-N-24	EP50S8-1024-1F-N-24	KT-302HS-0900
DAR (L) -R	7& : # SA " " " Z&@Z&S&	E40S6-600-3-T-24	EP50S8-1024-2F-N-24	LA8N-BF
DPU12A-025N	7& : # SA " " " Z&@Z&S&	E40S6-60-3-T-24	EP50S8-1024-2F-N-5	LA8N-BN
DPU12A-040R	7& : # SZ " " " Z&@Z&S&	E40S6-75-3-N-24	EP50S8-1024-2R-N-24	LE3S
DPU13A-050N	7& : (Z# S&Z Z&Z	E40S8-1000-3-T-24	EP50S8-1024-3F-N-24	LE3SA
DPU13A-070N	7& : (ZS " " Z&F Z&S&	E40S8-100-3-T-24	EP50S8-1024-3F-P-24	LE4S
DPU13B-120D	7& : (ZS " " " Z&Z	E40S8-1024-3-T-24	EP50S8-1024-3R-P-24	LE4SA
DPU13B-150N	7& : (Z% " " " Z&Z	E40S8-2000-3-N-24	EP50S8-256-3F-N-24	LE8N-BF
DPU13B-200D	7& : *Z# " " " Z&@Z&S&	E40S8-2000-6-L-5	EP50S8-256-3F-P-24	LE8N-BN
DPU13C-350D	7& : *Z# " " " Z&@Z	E40S8-200-3-T-24	EP50S8-360-1R-N-24	LE8N-BN-L
DPU13C-350N	7& : *Z# " " " Z&@Z&S&	E40S8-3600-6-L-5	EP50S8-360-2R-N-24	LR-W-06-VG
DPU13D-400N	7& : *Z# " Z&@Z&S&	E40S8-500-3-N-5	EP50S8-720-1R-N-24	M4N-DV-02
DPU14A-070N	7& : *Z# S&Z&@Z	E50S8-1000-3-T-24	EP50S8-720-1R-N-24	M4N-DV-13
DPU32A-025A	7& : *Z# S&Z&F Z&S&	E50S8-1000-6-L-5	EP50S8-720-2F-N-24	M4NN-DV-1N
DPU32A-040R	7& : *Z# S&Z Z&Z&S&	E50S8-100-3-N-24	EP58HB8-1024-1F-P-24	M4NS-NA M4N
DPU32A-050A	7& : *Z# S&Z Z&Z&S&	E50S8-100-3-T-24	EPM50S8-1013-B-PN-24	M4V M4W M4Y
	7& : *Z# S&Z Z&Z	E50S8-1024-3-N-24	EPM50S8-1013-B-S-24	M4W1P-DV-XX
			EPM50S8-1013-B-S-24-S	M4W-AV-6 M4YS
				M4YS-NA M5W
				M5W-T-DX-AC220

MD2U-ID20	PR12-2AC	PR12-2AC	PRFAT18-5DO-V	PSA-01
MD5-HD14	PR12-2AO	PR12-2AO	PRFAWT08-1.5DO-IV	PSAN-01CA-rc1/8
MD5-HD14-3X	PR12-2DN	PR12-2DN	PRFD18-7DO-V	PSAN-01CPA-RC1/8
MD5-HF14	PR12-2DN2	PR12-2DN2	PRL08-1.5DN	PSAN-01CV-RC1/8
MD5-HF14-A	PR12-2DP	PR12-2DP	PRL08-1.5DP2	PSAN-1CA-RC1/8
MD5-HF14-AO	PR12-2DP2	PR12-2DP2	PRL08-2DN	PSAN-1CV-RC1/8
MD5-HF28	PR12-4AC	PR12-4AC	PRL08-2DN2	PSAN-C01CA-RC1/8
MD5-ND14	PR12-4AO	PR12-4AO	PRL08-2DP	PSAN-L1CPA-NPT1/8
MP5S-4N MP5S	PR12-4DN	PR12-4DN	PRL12-2DN	PSAN-V01CPV-RC1/8
MP5W-41 MP5W	PR12-4DN2	PR12-4DN2	PRL12-2DP	PSAN-V01CV
MP5W-42	PR12-4DP	PR12-4DP	PRL12-4DN	PSAN-V01CV-RC1/8
MP5W-44	PR12-4DP2	PR12-4DP2	PRL12-4DN2	PSE17-5DN
MP5W-45	PR18-5AC	PR18-5AC	PRL12-4DP	PSE17-5DN2
MP5W-48	PR18-5AO	PR18-5AO	PRL12-4DP2	PSE17-5DP
MP5W-49	PR18-5DN	PR18-5DN	PRL18-5AC	PSK1-C01C-R1/8
MP5W-4A	PR18-5DN2	PR18-5DN2	PRL18-5AO	PSM4-APD
MP5W-4N	PR18-5DP	PR18-5DP	PRL18-5DN	PSN17-5DN
MP5Y-41 MP5Y	PR18-5DP2	PR18-5DP2	PRL18-5DN2	PSN17-5DN2
MP5Y-42	PR18-8AC	PR18-8AC	PRL18-5DP	PSN17-5DN2U
MP5Y-44	PR18-8AO	PR18-8AO	PRL18-5DP2	PSN17-5DN-F
MP5Y-4N	PR18-8DN	PR18-8DN	PRL18-8AC	PSN17-5DNU
MS-2	PR18-8DN2	PR18-8DN2	PRL18-8AO	PSN17-5DP
MS-2A	PR18-8DN-S	PR18-8DN-S	PRL18-8DN	PSN17-5DP2
MS4W-AV-4N	PR18-8DP	PR18-8DP	PRL18-8DN2	PSN17-5DPU
MS4W-DA-4N	PR18-8DP2	PR18-8DP2	PRL18-8DP	PSN17-8DN
MS4W-DV-4N	PR30-10AO	PR30-10AO	PRL18-8DP2	PSN17-8DN2
MS4Y-AA-4N	PR30-10DN	PR30-10DN	PRL30-10DN	PSN17-8DNU
MS4W MS4Y	PR30-10DP	PR30-10DP	PRL30-10DP	PSN17-8DP
MT4N-AA-40	PR30-15AC	PR30-15AC	PRL30-15AC	PSN17-8DP2
MT4N-DV-E0	PR30-15AO	PR30-15AO	PRL30-15AO	PSN30-10DN
MT4N-DV-E4	PR30-15DN	PR30-15DN	PRL30-15DN	PSN30-10DP
MT4N MT4W	PR30-15DN2	PR30-15DN2	PRL30-15DP	PSN30-15DN
MT4W-AA-40	PR30-15DP	PR30-15DP	PRMW18-8DU1	PSN30-15DP
MT4W-AA-41	PR30-15DP2	PR30-15DP2	PRS12-4DN	PSN30-15DP2
MT4W-AA-4N	PRAT18-5DO	PRAT18-5DO	PRS12-4DN2	PSN40-20AO
MT4W-AV-40	PRCM12-2DN	PRCM12-2DN	PRS12-4DP	PSN40-20DN
MT4W-AV-41	PRCM12-2DP	PRCM12-2DP	PRT08-1.5DO	PSN40-20DN2
MT4W-AV-4N	PRCM12-4DN	PRCM12-4DN	PRT08-2DC	PSN40-20DP
MT4W-DA-11	PRCM12-4DN2	PRCM12-4DN2	PRT08-2DO	PSNT17-5DC
MT4W-DA-40	PRCM12-4DP	PRCM12-4DP	PRT12-2DC	PSNT17-5DCU
MT4W-DA-41	PRCM12-4DP	PRCM12-4DP	PRT12-2DO	PSNT17-5DO
MT4W-DA-4N	PRCM12-4DP2	PRCM12-4DP2	PRT12-4DC	PSS-01A-R1/8
MT4W-DV-40	PRCM18-5DN	PRCM18-5DN	PRT12-4DO	PSS-1A-R04
MT4W-DV-41	PRCM18-5DP	PRCM18-5DP	PRT18-5DC	PSS-1A-R1/8
MT4W-DV-44	PRCM18-5DP2	PRCM18-5DP2	PRT18-5DO	PSS-C01V-R06
MT4W-DV-48	PRCM18-8AC	PRCM18-8AC	PRT18-8DC	PSS-V01A-R04
MT4W-DV-4N	PRCM18-8AO	PRCM18-8AO	PRT18-8DO	PTE-APV-302-RYG
MT4Y-AA-4N	PRCM18-8DN	PRCM18-8DN	PRT30-10DC	PTE-APZ-302-RYG
MT4Y-AV-40	PRCM18-8DP	PRCM18-8DP	PRT30-10DO	PTE-DMV-302-RYG
MT4Y-AV-43	PRCM18-8DP2	PRCM18-8DP2	PRT30-15DC	PTF30-G2NN-F8
MT4Y-AV-4N	PRCM30-10DN	PRCM30-10DN	PRT30-15DO	PTF30-G4NN-F8
MT4Y-DA-43	PRCM30-15DN	PRCM30-15DN	PRW08-1.5DN	PTF30-GFNN-F8
MT4Y-DA-44	PRCM30-15DP	PRCM30-15DP	PRW08-1.5DP	S16BR-H1R2C
MT4Y-DA-4N	PRCML18-5DN	PRCML18-5DN	PRW08-2DN	S16BR-H3G
MT4Y-DV-40	PRCML18-5DN2	PRCML18-5DN2	PRW08-2DN-V	S16BR-H3R
MT4Y-DV-41	PRCML18-5DP	PRCML18-5DP	PRW08-2DP	S16BR-H3RC24
MT4Y-DV-4N	PRCML18-5DP2	PRCML18-5DP2	PRW08-2DP-V	S16ER-E3RB24
MX4W-A-FN	PRCML18-8DN	PRCML18-8DN	PRW12-2DN	S16KR-2BK
MX4W-V-FN	PRCML18-8DP	PRCML18-8DP	PRWL08-1.5DN2	S16KR-2BKC
MT4Y MX4W	PRCML18-8DP2	PRCML18-8DP2	PRWL08-2DP	S16PR-E3GC24
PA10-U	PRCMT12-2DO	PRCMT12-2DO	PRWL18-8DN	S16PR-E3RC24
PA10-W	PRCMT12-4DC	PRCMT12-4DC	PRWL18-8DP	S16SR-L4B2C24
PA-12	PRCMT12-4DO	PRCMT12-4DO	PRWT08-1.5DO	S16SR-S4B2C
PFI25-8DN	PRCMT18-5DO	PRCMT18-5DO	PRWT12-2DO	S16SR-S4W2C
PFI25-8DN2	PRCMT18-8DO	PRCMT18-8DO	PRWT12-4DO	S2ER-E3RB
PFI25-8DN-HC	PRCMT30-10DO	PRCMT30-10DO	PRWT18-5DO	S2ER-E4RBD
PFI25-8DP	PRCMT30-15DC	PRCMT30-15DC	PRWT18-8DO	S2KR-2FKAB
PFI25-8DP2	PRCMT30-15DO	PRCMT30-15DO	PRWT30-15DC	S2PR-P1GA
PG-08	PRD08-2DN2-V	PRD08-2DN2-V	PS-08	S2PR-P1RA
PG-11	PRD08-2DP	PRD08-2DP	PS-08(N)	S2PR-P1RB
PMC-2HS-USB	PRD08-2DP2	PRD08-2DP2	PS-11	S2PR-P1YA
PMC-4B-PCI	PRD08-4DN2	PRD08-4DN2	PS-11(N)	S2PR-P3BAD
PR08-1.5DN			PS12-4DN	S2PR-P3GAD
PR08-1.5DN2			PS12-4DN2	S2PR-P3RAD
PR08-1.5DP			PS12-4DNU	S2PR-P3RBDM
PR08-1.5DP2			PS50-30DN	S2PR-P3WAD
PR08-2DN			PS50-30DP	S2PR-P3YAD
PR08-2DN2				S2SRN-S4BRAB
PR08-2DP				S2SRN-S4BWAB
PR08-2DP2				S2SRN-S8RAB
				S2SRN-S8WAB
				S2SR-S4WA
				S2TR-P1WAB

北京 15601379173(微信)

SCM-38I
SCM-US
SCM-US48I
SF2ER-B
SF2ER-B3
SF2ER-E1R2B
SF2ER-E1R3B
SF2ER-E1RA2B
SF2ER-E1RAB
SF2ER-E1RB
SF2ER-E2R2B
SF2ER-E2R2B-A
SF2ER-E2R2B-S
SF2ER-E2R3B
SF2ER-E2R3B-A
SF2ER-E2R3B-S
SF2ER-E2RA2B
SF2ER-E2RAB
SF2ER-E2RAB-A
SF2ER-E2RAB-S
SFD-A2B-M20
SFD-AB-M20
SFD-KLF
SFD-KLF2
SFDL-CND10-1
SFDL-M6A-G1/2
SFDL-M6A-M20
SFDL-MA-M20
SFDL-SA-CM20
SFDL-SA-M20
SFDL-SDK
SFL14-111
SFL20-24
SFL30-48
SFLA30-12
SFL-C3R
SFL-C3T
SFL-EC03R
SFL-EC03T
SFN-M-020
SFN-M-050
SFN-M-W
SH4-H1-KO
SL4-C110
SL4-C15F
SPB-060-12
SPB-060-24
SPB-120-24
SPB-240-24
SPC1-35-E
SPC1-50-E
SPW-050-24
SR1-1210-N
SR1-1220-N
SR1-1225-N
SR1-1240-N
SR1-1410-N
SR1-1420-N
SRC1-1215-N
SRH1-1215
SRH1-1220-N
SRH1-1230
SRH1-1420 20A(ZC)
SRH1-1420-N
SRH1-1430-N
SRH1-A420-N
SRS1-B1205R-1
SS-3071
T3S-B4RK4C
T3S-B4RK4C
T3S-B4RK4C-N
T3S-B4RP4C
T3S-B4RP4C-N
T3SI-N4NP4C-N

T4MA-B4SK4C-N
T4WI-N4NJ5C-N
T4YI-N4NKCC-N
TAS-B4RJ4C
TAS-B4RK2C
TAS-B4RK4C
TAS-B4RK6C
TAS-B4RP2C
TAS-B4RP4C
TAS-B4SK4C
TAS-B4SP2C
TAS-B4SP4C
TC3YF-14R
TC3YT-B4R3
TC4H-14R
TC4H-24R
TC4L-14R
TC4L-24R
TC4M-14R
TC4M-24R
TC4S-14R
TC4S-24R
TC4S-N4N
TC4S-N4R
TC4SP-14N
TC4SP-14R
TC4W-24R
TC4Y-14R
TCN4H-22R
TCN4H-24R
TCN4H-24RR
TCN4L-24R
TCN4M-22R
TCN4M-24R
TCN4S-22R
TCN4S-24R
TH4M-24R
THD-WD1-C
THD-WD1-T
THD-WD1-V
TK4H-14CR
TK4H-14RN
TK4H-24CR
TK4H-B2CC
TK4H-B4CN
TK4H-B4CR
TK4H-B4RR
TK4H-B4SR
TK4H-R2RN
TK4H-T4RN
TK4H-T4RR
TK4L-B4CC
TK4L-B4CN
TK4L-B4RN
TK4M-14RN
TK4M-24RN
TK4M-24RR
TK4M-24SN
TK4M-R4RR
TK4N-14CN
TK4S-12RN
TK4S-14CN
TK4S-14RN
TK4S-14RR
TK4S-14SN
TK4S-14SR
TK4S-24CR
TK4S-24RN
TK4S-24RR
TK4S-24SN

4006-022-002

TK4S-B4CC
TK4S-B4CN
TK4S-B4CR
TK4S-B4RC
TK4S-B4RN
TK4S-B4SN
TK4SP-14RN
TK4SP-14SN
TK4S-R4CN
TK4S-R4CN
TK4S-R4RN
TK4S-T4CC
TK4S-T4CN
TK4S-T4CR
TK4S-T4RN
TK4S-T4SC
TK4S-T4SC
TK4S-T4SN
TM2-22CB
TM2-22CE
TM2-22RB
TM4-N2RB
TM4-N2RE
TM4-N2RE G
TM4-N2SB
TM4-N2SB G
TM4-N2SE
TM4-N2SE G
TMH4-N2CB
TMH4-N2CE
TMHC-22EE
TMHE-82RE
TNH-44CR-RS-031
TNH-44RR-RS-006
TNH-P44SR-RS-006
TNL-46RR-RS-035
TNL-P46CC-RS-035
TNS-42RR-NS-006
TNS-P42RR-NS-006
TOS-B4RK2C
TOS-B4RK4C
TOS-B4SK4C
TPS20(0-20)
TPS20-G15F8-00
TPS20-G16F8-00
TPS20-G16P2-00
TPS20-G17P2-00
TPS20-G17P2-00
TPS20-G1AP2-00
TPS20-G1CF8-00
TPS20-G1CP2-00
TPS20-G1MF8-00
TPS20-G1MP2-00
TPS20-G1QF8-00
TPS20-G26F8-00
TPS20-G2Z-F8-00
TPS20-G3HF8-00
TPS30-G26AN4-00
TR1D-14CN
TR1D-R4CC
TWD-HS1-T
TWD-RF1-T
TWP-RF1-S
TX4H-24C
TX4H-A4C
TX4H-B4C
TX4H-B4R
TX4L-14C
TX4M-B4S
TX4S-14C
TX4S-14R
TX4S-14S

17372005357 长沙

TX4S-24C
TX4S-24R
TX4S-24S
TX4S-A4C
TX4S-A4S
TX4S-B4C
TX4S-B4R
TX4S-B4S
TZ4H-14R
TZ4H-14S
TZ4H-24R
TZ4L-14C
TZ4L-14R
TZ4M-14R
TZ4M-24R
TZ4SP-14R
TZ4SP-14S
TZ4ST-14C
TZ4ST-14R
TZ4ST-14S
TZ4ST-24S
TZ4ST-R4R
TZ4ST-R4S
TZ4W-14R
TZ4W-24C
TZN4H-14R
TZN4H-14S
TZN4L-14R
TZN4M-14C
TZN4M-14S
TZN4M-24R
TZN4M-A4R
TZN4M-R4R
TZN4S-14C
TZN4S-14R
TZN4S-14S
TZN4W-14S
VG-C04R-16E
VG-M04W-16E
VG-M04W-8E

T3S
T3SI
T4M
T4MA
T4W
T4WI
T4YI
TAS
TC3Y
TC3YF
TC3YT
TC4H
TC4L
TC4M
TC4S
TC4SP
TC4W
TC4Y
TCN4H
TCN4L
TCN4M
TCN4S
TH4M
TK4H
TK4L
TK4M
TK4N
TK4S
TK4SP
TK4S
TM2
TM4
TMH4
TMHC
TMHE
TNH
TNH-P
TNL
TNL-P
TNS
TNS-P
TOS
TR1D
TX4H
TX4L
TX4M
TX4S
TZ4H
TZ4L
TZ4M
TZ4SP
TZ4ST
TZ4W
TZN4H
TZN4L
TZN4M
TZN4S
TZN4W