

TW series

Single axis self-centering thumb controls •
non-contacting Hall effect technology



DISTINCTIVE FEATURES

- Analog outputs
- Spring return to center
- Choice of 4 wheel colors
- 5 million lifecycles
- Electronics sealed up to IP67



ENVIRONMENTAL SPECIFICATIONS

- Operating Temperature: -40 °C to +85 °C (-40 °F to +185 °F)
- Storage Temperature: -40 °C to +85 °C (-40 °F to +185 °F)
- Sealing: IP67 (electronics)
- EMC Immunity Level: EN61000-4-3 (extended)
- EMC Emissions Level: EN61000-6-3: 2001
- ESD: EN61000-4-2 (extended)



ELECTRICAL SPECIFICATIONS

- Supply Voltage Range: 5.00 VDC \pm 0.250 VDC
- Reverse Polarity max: -10 VDC
- Overvoltage max: 20 V
- Output Impedance: 2 Ω
- Return to Center Voltage Tolerance (no load): \pm 200 mV



MECHANICAL SPECIFICATIONS

- Operating Force: 0.7 N (0.15 lbf)
- Maximum Vertical Load: 111 N (25 lbf)
- Maximum Horizontal Load: 133 N (15 lbf)
- Mechanical Angle of Movement: 80° (\pm 40° from center)
- Expected Life: 5 million lifecycles
- Mass/weight: 35 g \pm 5 g (1.23 oz \pm 0.18 oz)
- Lever Action (centering): Spring

The company reserves the right to change specifications without notice.

4006-022-002

shunto@126.com

TW series

Single axis self-centering thumb controls • non-contacting Hall effect technology

MATERIALS

- Body: Glass filled nylon
- Actuator: Glass filled nylon

CONNECTIONS

CONNECTOR PINOUT

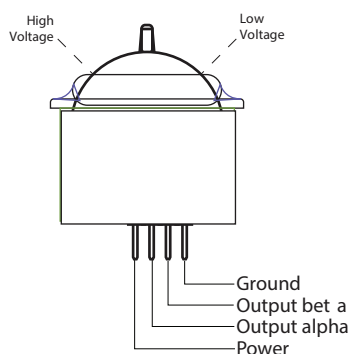

- Connector termination option : The TW Series Thumbwheel may be specified with a TE Connectivity 2.54 mm pitch male header. When selected from the "Option Selection" guide, both single and dual output configurations feature a four position TE 3-647166-4 connector
- Optional mating harness The TW Series is available with an optional mating harness. the four function harness is part number 505-498.
 - Wire type : 22 AWG 25 cm PTFE
 - Connector: Molex 0050579504

DEFAULT WIRE COLOR CODE		
COLOR	FUNCTION	AWG
Red	+5 V	22
Black	Ground	
Blue	Output alpha	
Blue/White	Output beta	

CIRCUIT	WIRE COLOR
Pin1	Black
Pin2	Blue/White
Pin3	Blue
Pin4	Red

MOUNTING

PANEL CUT-OUT

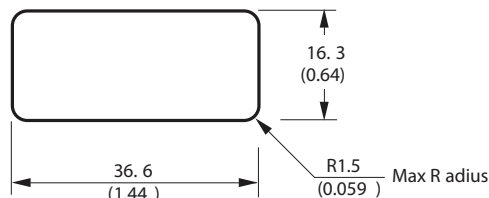

STEEL SPRING RETAINER*

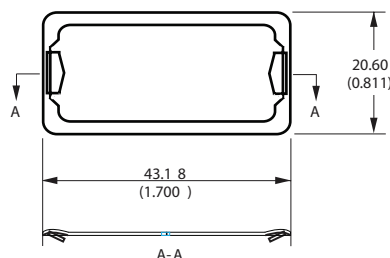

* - used for installation

INSTALLATION

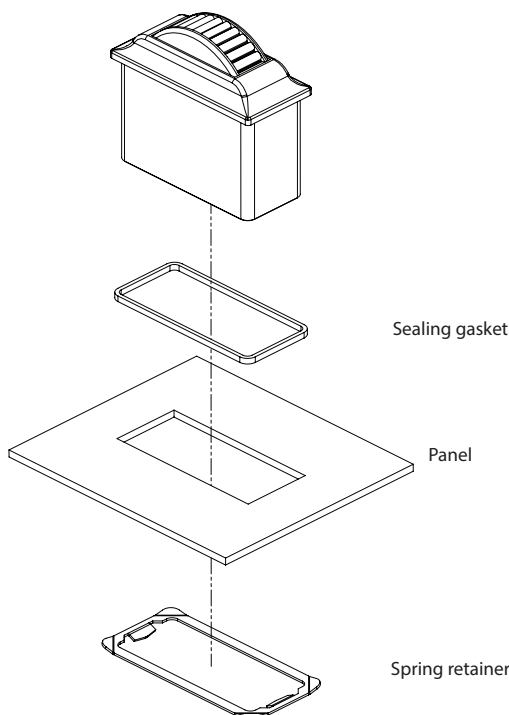

TW series

Single axis self-centering thumb controls • non-contacting Hall effect technology



BUILD YOUR PART NUMBER

SERIES	MODEL	OUTPUT OPTIONS	ACTUATOR COLOR	SPRING TENSION	TERMINATION
TW					
0 With tab		1 0V to 5V	BLK Black	1 Standard	1 2.54 mm (.100") Pitch Male Header
1 Without tab		2 0.5V to 4.5V	RED Red		2 22AWG 41cm PTFE
		3 1V to 4V	BLU Blue		3 28AWG 41cm PTFE
		4 0V to 5V - Sensor 1 0V to 5V - Sensor 2	GRY Grey		4 2.54 mm (.100") Pitch Male Header with Mating Harness 25cm
		5 0.5V to 4.5V - Sensor 1 0.5V to 4.5V - Sensor 2			
		6 1V to 4V - Sensor 1 1V to 4V - Sensor 2			
		7 0V to 5V - Sensor 1 5V to 0V - Sensor 2			
		8 0.5V to 4.5V - Sensor 1 4.5V to 0.5V - Sensor 2			
		9 1V to 4V - Sensor 1 4V to 1V - Sensor 2			

EXAMPLE APPLICATION



4006-022-002

shunto@126.com

TW series

Single axis self-centering thumb controls • non-contacting Hall effect technology

DIMENSIONS

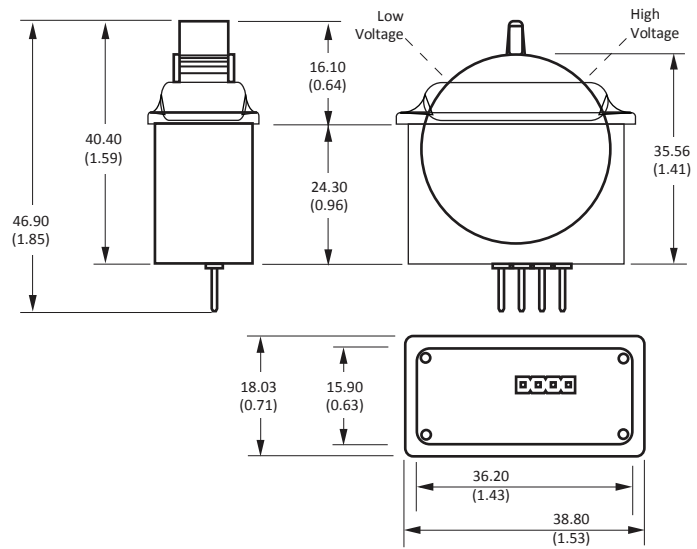

VOLTAGE OUTPUT OPTIONS

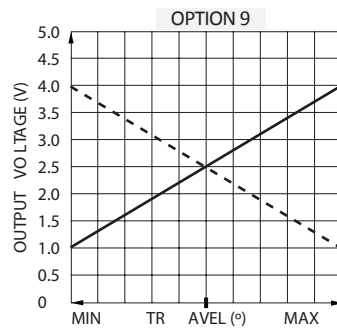
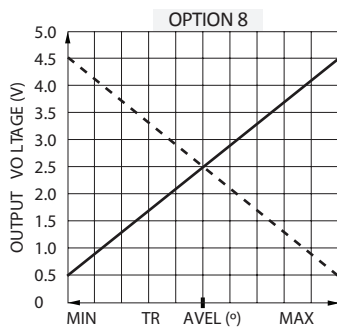
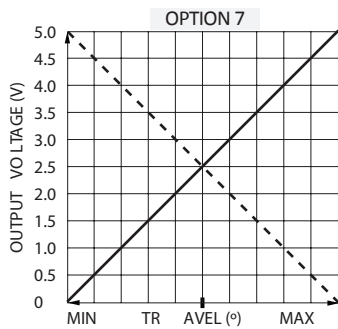
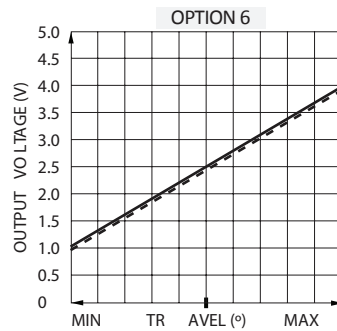
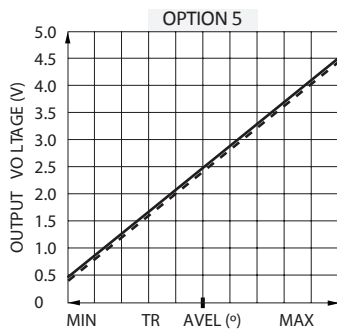
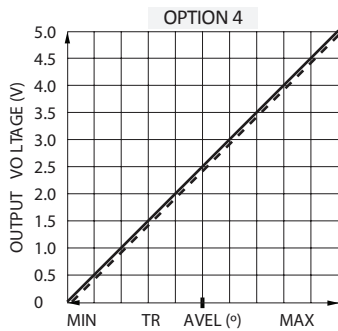
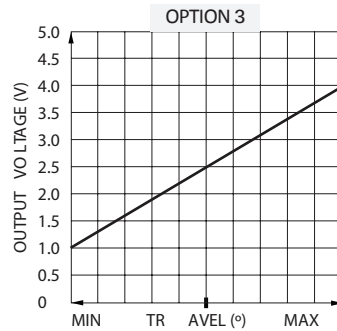
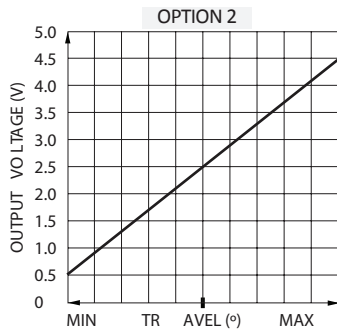
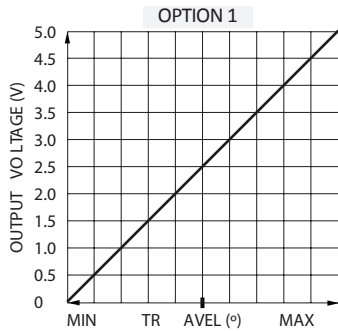

— Output 1
- - - Output 2