



MCH13 使用说明书

USE AND MAINTENANCE
MANUAL 使用保养手册

CONTENTS	
4 - TECHNICAL DATA	2
4.1 Technical characteristics	2
4.1.1 Crankcase, crankshaft, cylinder, pistons	2
4.1.2 Valves	2
4.1.3 Safety valves	2
4.1.4 Pressure maintenance valve	2
4.1.5 Lubrication	2
4.1.6 Cooling tubes	2
4.1.7 Frame, guards	2
4.1.8 Pressure gauges	2
4.2 Machine parts	3
4.3 Technical characteristics	4
4.4 Pressure circuit	5
4.5 Wiring diagram	6
5 - HANDLING AND INSTALLATION	7
5.1 Unpacking	7
5.2 Handling	7
5.3 Installation	8
5.3.1 Positioning	8
5.3.2 Air intake extension connection	9
5.3.3 Electrical connection	9
6 - USING THE COMPRESSOR	10
6.1 Preliminary checks before using for the first time	10
6.1.1 Inserting filtration cartridge	10
6.1.2 Checking for proper electrical connection (for three-phase electric motor only)	10
6.1.3 Refill hoses connection	10
6.2 Checks to be run at the start of each working day	11
6.2.1 Lubricating oil level check	11
6.2.2 Storing technical documentation	11
6.2.3 Checking that the flex hoses are in good condition	11
6.2.4 Checking the safety valves	12
6.3 Control panel (optional)	13
6.4 Starting and shutting down	14
6.5 Tank refill	15
6.6 Optional	17
6.6.1 Control panel	17
6.6.2 Automatic shutdown with pressure switch	17
6.6.3 Automatic condensate discharge	17
6.6.4 Filling panels	18
6.6.5 Filling connections	18
6.6.6 Filling hoses	18
6.6.7 C_MONITOR monitoring system (optional)	19
7 - MAINTENANCE	20
7.1 Foreword	20
7.2 General	20
7.3 Unscheduled work	21
7.4 Scheduled maintenance table	21
7.5 Troubleshooting	22
7.6 Condensate discharge	23
7.7 Changing the intake filter	24
7.8 Purifier filter	25
7.9 Checking and changing the lubricating oil	27
7.10 Changing the flex hose	29
7.11 Transmission belt	30
7.12 Safety valve	31

目录	
4 - 技术数据	2
4.1 技术特点	2
4.1.1 曲轴箱、曲轴、气缸、活塞	2
4.1.2 阀门	2
4.1.3 安全阀	2
4.1.4 压力维持阀	2
4.1.5 润滑	2
4.1.6 冷却管	2
4.1.7 框架, 防护装置	2
4.1.8 压力表	2
4.2 机械零件	3
4.3 技术特点	4
4.4 压力回路	5
4.5 接线图	6
5 - 搬运和安装	7
5.1 拆开包装	7
5.2 搬运	7
5.3 安装	8
5.3.1 定位	8
5.3.2 进气口延伸连接	9
5.3.3 电气连接	9
6 - 使用压缩机	10
6.1 在使用前进行初步检查。	10
6.1.1 插入过滤桶	10
6.1.2 检查电气连接是否正确 (仅适用于三相电动马达)	10
6.1.3 加注软管连接	10
6.2 工作日开始时的检查	11
6.2.1 润滑油油位检查	11
6.2.2 储存技术文件	11
6.2.3 检查加注软管是否处于良好状态	11
6.2.4 检查安全阀	12
6.3 控制面板 (可选)	13
6.4 启动和关闭	14
6.5 容器加注	15
6.6 可选类型	17
6.6.1 控制面板	17
6.6.2 带压力开关的自动停机	17
6.6.3 冷凝水自动排放	17
6.6.4 充气面板	18
6.6.5 充气接头	18
6.6.6 充气软管	18
6.6.7 C_MONITOR监控系统	19
7 - 维修	20
7.1 前言	20
7.2 概述	20
7.3 计划外工作	21
7.4 定期维护表	21
7.5 故障排除	22
7.6 冷凝水排放	23
7.7 更换进气滤清器	24
7.8 净化器过滤器	25
7.9 检查和更换润滑油	27
7.10 更换柔性软管	29
7.11 传送皮带	30
7.12 安全阀	31

4 - TECHNICAL DATA

4.1 TECHNICAL CHARACTERISTICS

4.1.1 Crankcase, crankshaft, cylinders, pistons

The crankcase is made of an aluminium alloy cast in gravity shell, the flanges are die-cast in aluminium. The goose neck is made of forged steel, the connecting rods are in forged aluminium.

The flanges with roller bearings that support the crankshaft are kept oil-tight with the crankcase by O-rings between flange and crankcase and the oil retainer between flange and motor shaft.

The crankshaft and the connecting rods run on bearings with roller cages only. The connecting rods are fitted on the crankshaft with a single crank angle.

The cylinders are die-cast in aluminum with internal coating of nickel and silicon, the pistons of the first and second stage are made of aluminum, the piston of the third stage is made of steel. The sealing bands are in cast iron. The pistons of the second and third stages are floating.

4.1.2 Valves

The heads set features outlet and intake valves. The 1st stage head is reed valve type and includes both intake and pressure.

The intake and discharge valves of the second stage, made of stainless steel, are placed directly in the respective seats of the head.

The head of the third stage houses a coaxial intake and discharge valve.

4.1.3 Safety valves

The safety valves are pre-adjusted during assembly of the compressor and prevent it being damaged in the event of a malfunction. The max pressure, as a function of the valve, as follows:

1 st stage safety valve	10Bar / 145PSI
2 nd stage safety valve	70Bar / 1015PSI
3 rd stage safety or final valve	232-300-330Bar / 3300-4300-4700PSI



WARNING: It is strictly forbidden to carry out any adjustments to the valve to raise its factory preset pressure. Tampering with the safety valve can cause serious damage and renders the warranty null and void.

4.1.4 Pressure maintenance valve

This valve is fitted after the final filter. When the compressor is switched on it keeps internal system pressure at 100 ±20 bar so as to remove as much water as possible from the air.

4.1.5 Lubrication

Splash lubrication occurs by oil thrower pin onto the 1st stage connecting rod.

4.1.6 Cooling tubes

The cooling pipes are made of stainless steel. The condensate separators are made of aluminium.

4.1.7 Frame, guards

The compressor and motor are mounted on a welded steel frame that has been painted with epoxy resins. Stainless steel frame available on request.

4.1.8 Pressure gauges



IMPORTANT: The gauges installed compressors have a precision class of 1.6 (±1.6% on the full scale value).

4 - 技术数据

4.1 技术特点

4.1.1 曲轴箱、曲轴、气缸、活塞

曲轴箱由重力压铸铝合金制成，法兰盘为压铸铝。曲轴是由锻造钢制成的，连杆是由锻造铝制成的。

带有支撑鹅颈的滚子轴承的法兰与气缸体之间通过法兰和气缸体之间的O型圈以及法兰和驱动轴之间的油封进行油密。

曲轴和连杆完全在滚子笼轴承上旋转。连杆以单一曲柄角度安装在鹅颈上。

气缸采用铝压铸，内层镀镍和硅，第一级和第二级活塞用铝制成，第三级活塞用钢制成。活塞环是由铸铁制成的。第二和第三级活塞是浮动的。

4.1.2 阀门

头部设置有出气和进气阀。第一级阀门为簧片阀类型，包括进气和出气。

第二级的进气阀和排气阀由不锈钢制成，直接放置在机头的各自座位上。

第三级的头部有一个同轴的进气和排气阀。

4.1.3 安全阀

安全阀在压缩机组装过程中被预先调整好，防止其在发生故障时被损坏。最大的压力，作为阀门的功能，如下所示。

1级安全阀	10Bar / 145PSI
2级安全阀	70Bar / 1015PSI
3级安全阀	200-232-300-330Bar / 2900-3300-4300-4700PSI



警告: 严禁对阀门进行任何调整以提高其出厂预设压力。

篡改安全阀会造成严重的损坏，使保修失效。

4.1.4 压力维持阀

该阀安装在最终过滤器之后。当压缩机开启时，它将内部系统压力保持在100 ±20巴，以便尽可能多地从空气中去除水分。

4.1.5 润滑

飞溅式润滑是通过抛油器针头在第一级连杆上进行的。

4.1.6 冷却管

冷却管是由不锈钢制成的。冷凝液分离器是由铝制成的。

4.1.7 框架，防护装置

压缩机和电机安装在一个焊接的钢架上，钢架上涂有环氧树脂。可根据要求提供不锈钢框架。

4.1.8 压力表

重要提示: 安装在压缩机上的测量仪的精度等级为1.6 (满刻度值的±1.6%)

4.2 MACHINE PARTS

4.2 机械零件

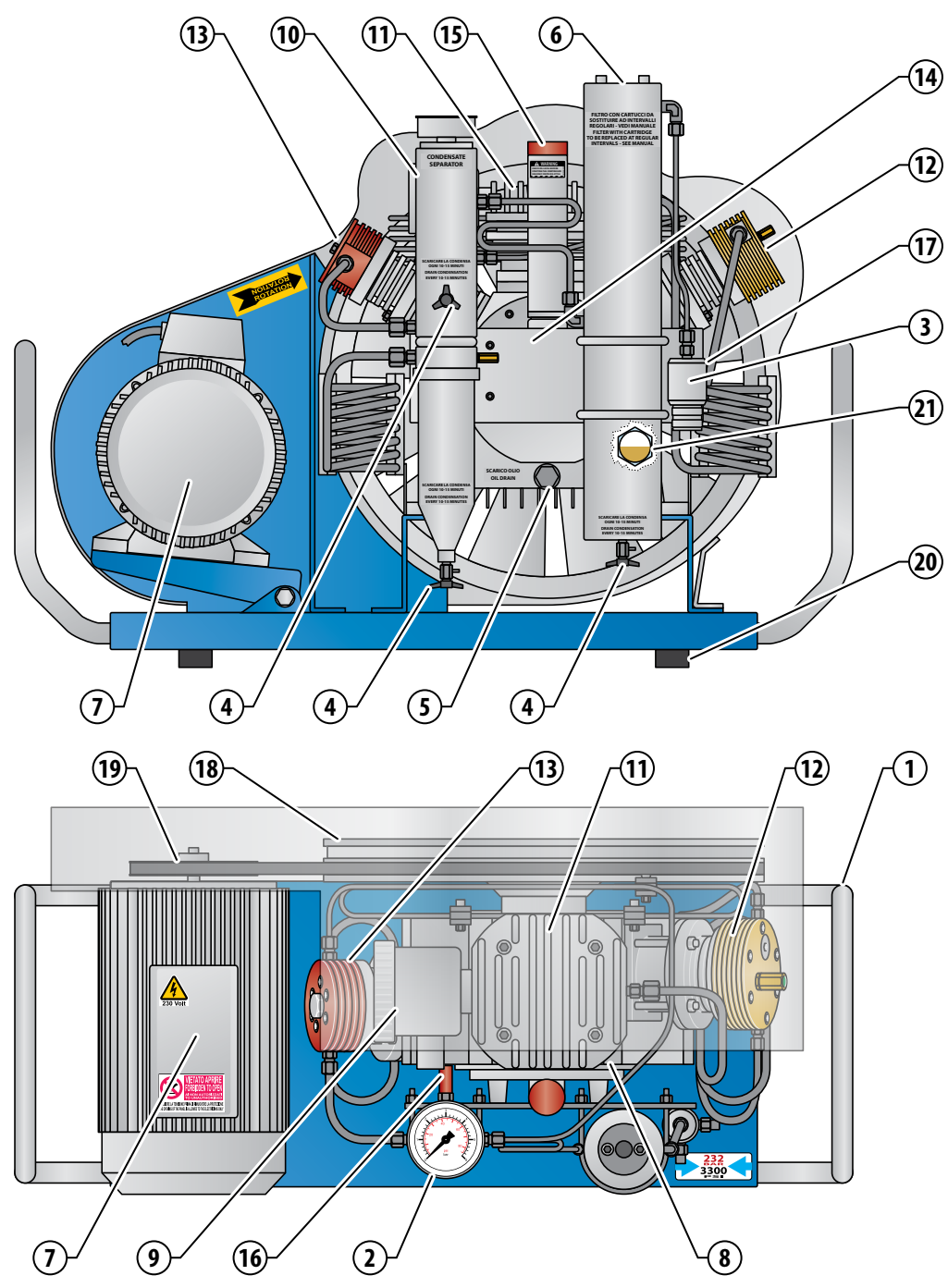

- | | | | |
|-------------------------------|--------------------------|-----------|---------|
| 1 Frame | 12 2nd stage | 1 框架 | 12 二级缸 |
| 2 Pressure gauge | 13 3rd stage | 2 压力表 | 13 三级缸 |
| 3 Refill hoses connection | 14 Monobloc | 3 加注软管连接 | 14 单片机 |
| 4 Condensate discharge valves | 15 Oil filler plug | 4 冷凝液排放阀 | 15 注油口塞 |
| 5 Oil discharge valves | 16 Safety valve | 5 排油阀 | 16 安全阀 |
| 6 Purifier filter | 17 Maintenance valve | 6 净化器过滤器 | 17 维修阀 |
| 7 Electric motor | 18 Cooling fan | 7 电动机 | 18 冷却风扇 |
| 8 Compressor | 19 Belt | 8 压缩机 | 19 皮带 |
| 9 Air filter | 20 Anti-vibration device | 9 空气过滤器 | 20 防震装置 |
| 10 Condensate separator | 21 Oil level | 10 冷凝水分离器 | 21 油位 |
| 11 1st stage | | 11 一级缸 | |

4.3 TECHNICAL CHARACTERISTICS

4.3 技术特点

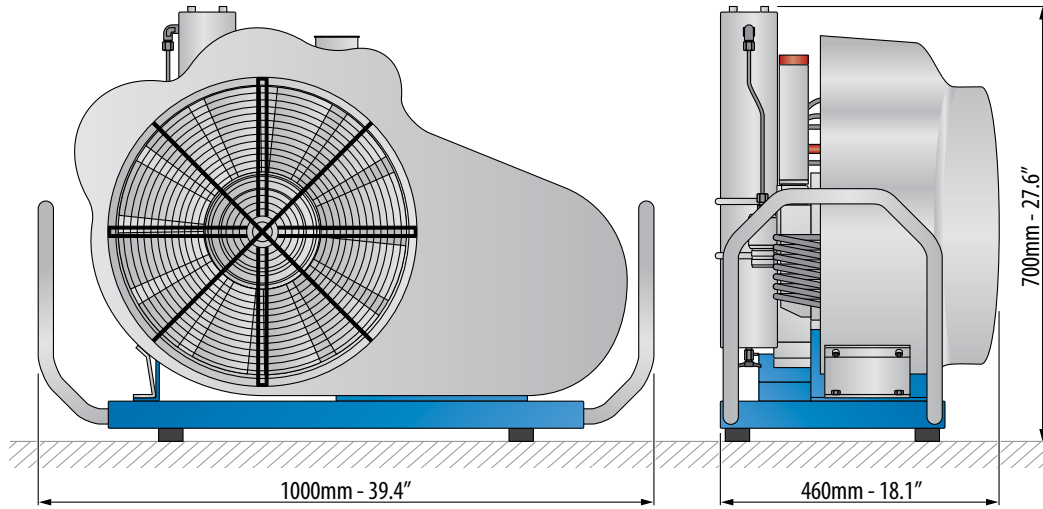

		MCH-8-11				MCH-13							
		MCH-8		MCH-11		MCH-13				MCH-16			
Electric Engine	电机类型	Single phase - 单相电				Three phase - 三相电							
Engine power	功率	(kW)		3		4				5,5			
		(Hp)		4		5,5				7,5			
Engine rpm	电机转速	(giri/min)(rpm)		2800 3400		2800 3400				2840			
Voltage	电压	(V)		230 230		230 230				230 400 230 400 440 480			
Frequency	频率	(Hz)		50 60		50 60				50 50 60 60 60 60			
Absorption	电流	(A)		18 16		24 22				15 8,7 15 8,7 8,7 8,7			
Pumping Unit	压缩机转速	(giri/min)(rpm)		1500		1040				1200			
Working pressure	工作压力	(bar)		232-300-330		232-300-330							
		(PSI)		3300-4300-4700		3300-4300-4700							
Charging rate	充气速度	(l/min)		125		195				235			
		m³/h		7,5		11,7				14,1			
		CFM (ft³/min)		4,4		6,9				8,3			
Refill time	充装时间	10l / 0-200bar (min)		16'		10'				8'30"			
Noise level	噪音	Lwa guaranteed (dB)		95		95				94			
		Lwa measured (dB)		92		92				91			
		Lpa measured (dB)		72		72				71			
Dry weight	重量	(Kg)		93		100				95			
		(lb)		205,0		220,5				209,4			
Dimensions	尺寸	(mm)		1000x460x700									
		(inches)		39,4x18,1x27,6									



ATTENTION: For single-phase compressors powered by a current generator, the power of the generator (for reloads at 232bar) must be:

Compressor:	Generator:
MCH-8/EM (230V-3kW)	minimum 11 kVA
MCH-11/EM (230V-4kW)	minimum 15 kVA



注意：对于由电流发生器供电的单相压缩机，发电机的功率（在232bar下重新加载）必须为：

压缩机:	电机:
MCH-8/EM (230V-3kW)	11 kVA minimo
MCH-11/EM (230V-4kW)	15 kVA minimo

4.4 PRESSURE CIRCUIT

4.4 压力回路

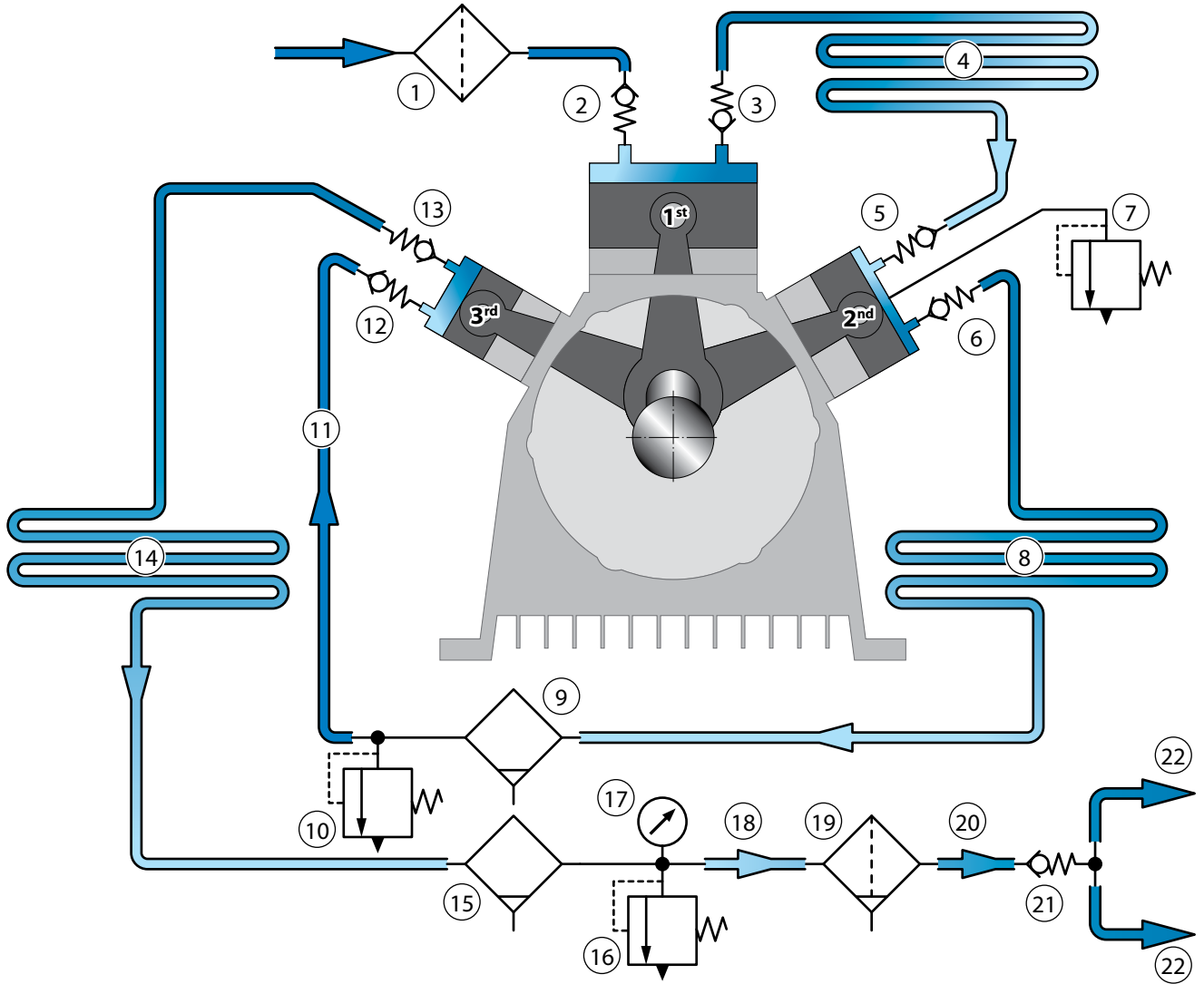

- 1 Intake filter
- 2 Intake valve 1st stage
- 3 Outlet valve 1st stage
- 4 Cooling pipe 1st-2nd stage
- 5 Intake valve 2nd stage
- 6 Outlet valve 2nd stage
- 7 Safety valve 1st stage
- 8 Cooling pipe 2nd/condensate separator LP
- 9 Condensate separator LP
- 10 Safety valve 2nd stage
- 11 Pipe separator/3rd stage
- 12 Intake valve 3rd stage

- 13 Outlet valve 3rd stage
- 14 Aftercooler
- 15 Condensate separator HP
- 16 Safety valve
- 17 Pressure gauge
- 18 Pipe separator/filter
- 19 Purifier filter
- 20 Pipe filter/ pressure maintenance valve
- 21 Pressure maintenance valve
- 22 Flex hoses

- 1 进气过滤器
- 2 第1级进气阀
- 3 第1级出口阀
- 4 冷却管第1至第2阶段
- 5 进气阀第2阶段
- 6 出气阀第2阶段
- 7 安全阀1级
- 8 冷却管第2级/冷凝水分离器LP
- 9 冷凝水分离器LP
- 10 安全阀第2级
- 11 管道分离器/第3级
- 12 进气阀3级

- 22 柔性软管
- 21 压力维持阀
- 20 管道过滤器/压力
- 19 净化器过滤器
- 18 管道分离器/过滤器
- 17 压力表
- 16 安全阀
- 15 冷凝水分离器 HP
- 14 后冷却器
- 13 第3级出口阀

4.5 WIRING DIAGRAM

4.5 接线图

MCH-13-16/ET SWITCHBOARD WITH:
自动冷凝水排放、自动停止、启动/停止开关、计时器

图N°	: 13-0001
相数 终端频率	: 3P+T 50/60HZ
电源控制板	: .. VAC
电压指令电路	: 230VAC
电压信号电路	:
总电源控制板	: 4/5,5 KW
总电流设备	: A
大电流设备	:
电源中断	: 6KA
保护等级	: IP 54

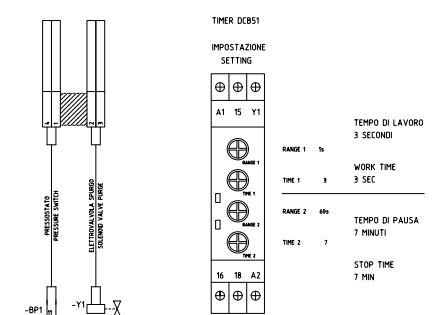
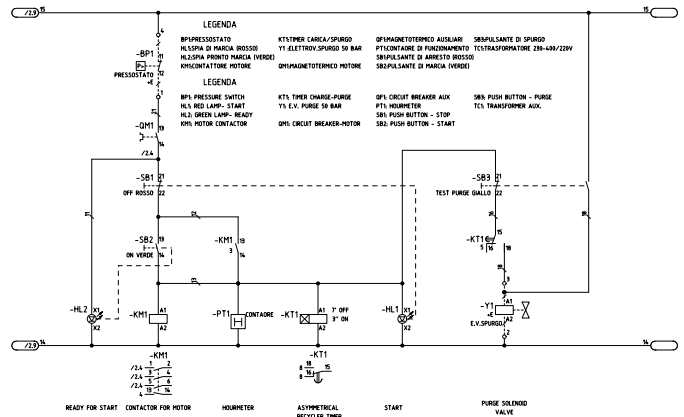
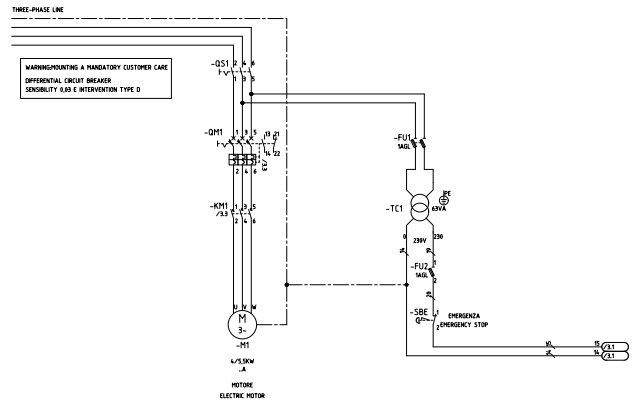

MCH-13-16/EM SWITCHBOARD WITH:
自动冷凝水排放、自动停止、启动/停止开关、计时器

图N°	: 13-00035
相数 终端频率	: 1P+T 50/60HZ
电源控制板	: .. VAC
电压指令电路	: 230VAC
电压信号电路	:
总电源控制板	: 4/5,5 KW
总电流设备	: A
大电流设备	:
电源中断	: 6KA
保护等级	: IP 54

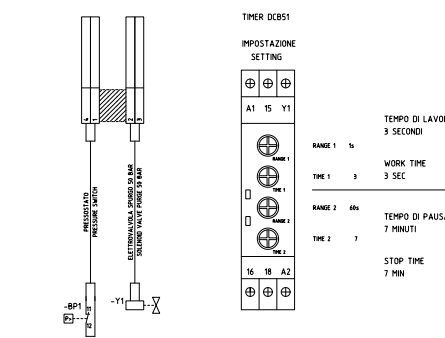
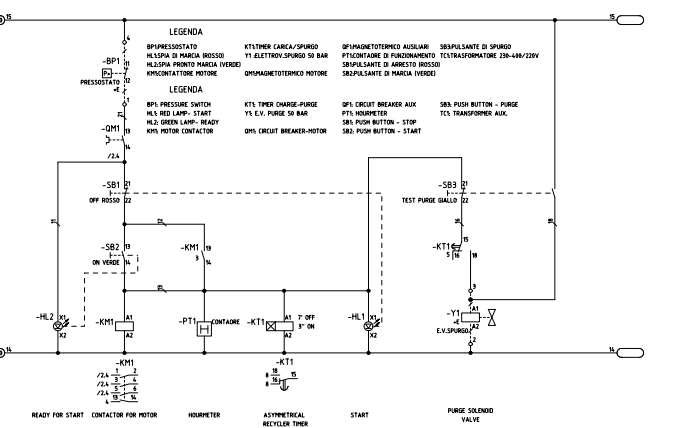
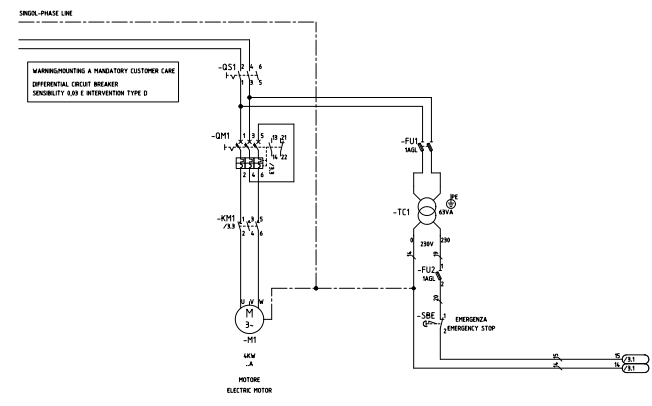

5 - HANDLING AND INSTALLATION

5.1 UNPACKING

The compressor is packed in a cardboard box on a pallet to simplify handling and transport.

The box containing the compressor must be moved according to the instructions shown on the box itself.

The machine is supplied with the following as standard:

- 2 Refill hoses 1200 mm;
- 2 Filling connection;
- 1 Active carbon and molecular sieve Maxifilter cartridge vacuum;
- 1 Use and maintenance manual;
- EC declaration of conformity.

5.2 HANDLING

After separating the compressor from its packaging it can be transported to the designated placement area.

Transfer will require the use of a fork-lift or transpallet (of suitable load-bearing capacity).

To lift the compressor use the carry handles (a).

If the compressor is to be lifted manually make sure the task is done by two workers, once again using the carry handles (a).

5 - 搬运和安装

5.1 拆开包装

压缩机被装在一个纸板箱中，放在一个托盘上，以简化搬运和运输。

装有压缩机的箱子必须按照箱子本身上的说明进行移动。

本机的标准配置如下：

- 2条加注软管1200毫米。
- 2个加注接口。
- 1个活性炭和分子筛滤芯（调试已安装）。
- 1本使用和维护手册。
- 欧共体符合性声明。

5.2 搬运

将压缩机从其包装中分离出来后，可以将其运送到运送到指定的放置区域。

搬运时需要使用叉车或运输车（具有适当的负载能力）。承重能力）。抬起压缩机时要使用提手（a）。

如果要手动抬起压缩机，请确保由两名工人完成这项任务。

如果需要手动抬起压缩机，请确保由两名工人完成，并再次使用提手（a）。



IMPORTANT: Proceeding with the utmost care when lifting, transferring and positioning the compressor.



WARNING: Manual lifting of the compressor requires at least two workers and in any case no individual worker should lift more than 30 Kg.



重要提示：在抬起、转移和定位压缩机时要极其小心。



警告：手动抬起压缩机至少需要两名工人。在任何情况下，任何一个工人都应该抬起超过30公斤的东西。

5.3 INSTALLATION



WARNING: Before proceeding with the installation tasks described below, read Chapter 3 "SAFETY REGULATIONS" carefully.

5.3.1 Positioning

- Position the compressor in the designated area and check it is level. For compressor dimensions please consult section 4.3 "Technical characteristics".
- Check that the area in which the compressor is to be positioned is adequately ventilated: good air exchange (more than one window), no dust and no risk of explosion, corrosion, fire and absence of harmful or toxic fumes and gases.
- If ambient temperatures exceed +40°C air conditioning will be necessary.
- Position the compressor no closer than 1 m to surrounding walls; the gap between compressor and ceiling should be at least 1.5 m. These distances ensure proper compressor operation and proper cooling of the pumping unit.
- Make sure that lighting in the area is sufficient to identify every detail (such as the writing on the info labels); use artificial lighting where daylight is on its own insufficient.

5.3 安装



警告：在进行下面的安装任务之前，请仔细阅读第3章“安全规定”。

5.3.1 定位

- 将压缩机放置在指定的区域，并检查其是否水平。关于压缩机的尺寸，请参考第4.3节“技术特性”。
- 检查放置压缩机的区域是否有足够的通风：良好的空气交换（一个以上的窗口），没有灰尘，没有爆炸、腐蚀、火灾的危险，没有有害或有毒的烟雾和气体。
- 如果环境温度超过+40°C，则需要进行空调降温。
- 将压缩机放置在离周围墙壁不超过1米的地方；压缩机和天花板之间的间隙应至少为1.5米。这些距离可以确保压缩机的正常运行和泵送装置的正常冷却。
- 确保该区域的照明足以识别每个细节（如信息标签上的文字）；在日光本身不足的情况下，使用人工照明。

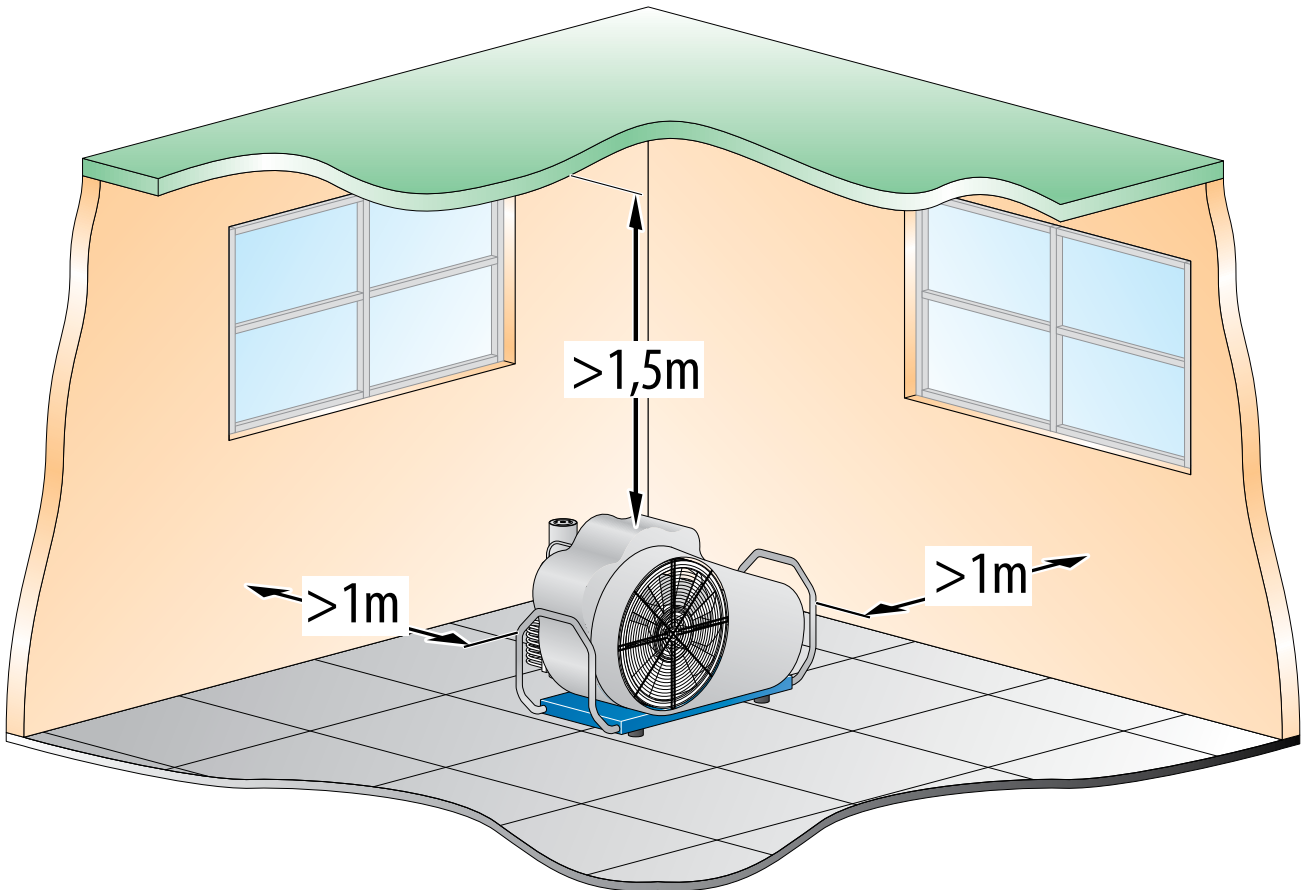

5.3.2 Air intake extension connection

If the compressor is installed in an area without the necessary ventilation requisites described in section 5.3.1 "Positioning", it will be necessary to install an air intake extension leading in from outdoors or a place with the cited ventilation requisites.

- The extension, supplied as an optional, must be connected to the intake connector (a).
- Connect extension pipe to fitting.
- Fit the supplementary intake filter on the extremity of the extension pipe.
- Position the end of the extension with the air intake filter in a properly ventilated area sheltered from weather and exhaust fumes.
- Point the air intake against the wind.
- Check that there are no kinks or breaks along the pipe. If it is damaged replace it.

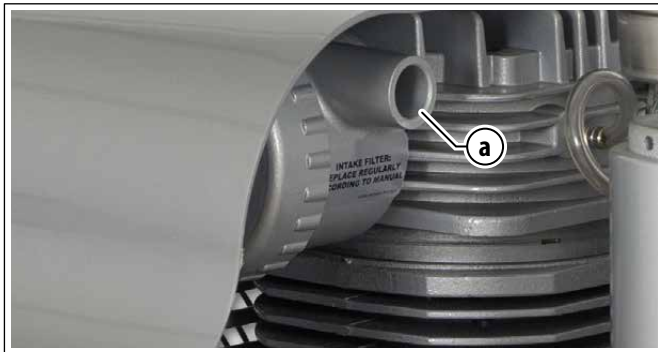

WARNING: Use only a flexible pipe with internal steel braiding reinforcement so as to prevent kinks and a consequent reduction of cross-section. Do not aspirate harmful gases or exhaust fumes.

5.3.3 Electrical connection

The compressor is supplied with an electrical lead. To connect up to the power supply just insert the plug in the mains power socket. Check that the data on the compressor ID plate is compatible with mains power supply, especially as regards rated current and voltage. The mains power system must have an efficient ground (earth); check that the earth resistance value complies with the protection / operational requirements of the compressor electrical system.

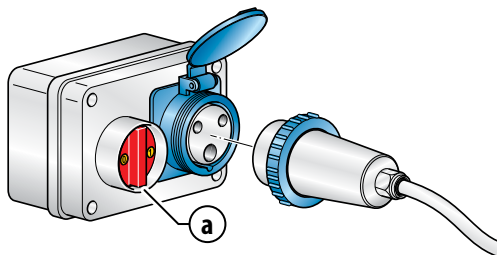

WARNING: Before inserting the plug, check that the electrical system complies with the standards in force in the country of installation. A proper earth (ground) system is an essential safety requisite. An efficient compressor ground (earth) system is an essential compressor safety requisite. The mains power connection plug must be type-approved in compliance with the relevant standards and have an ON-OFF switch (a) (not supplied).



DANGER: Check that the characteristics of the mains power are compatible with those of the compressor.

5.3.2 进气口延伸连接

如果压缩机安装在没有第5.3.1节“定位”所述的必要通风条件的区域，就必须安装一个从室外或具有所述通风条件的地方引来的进气口。

- 作为选配件提供的延长管必须连接到进气接头 (a)。
- 将延长管连接到接头。
- 将辅助进气过滤器安装在延长管的端部。
- 将带有进气过滤器的延长管末端放置在一个适当的通风区域，避开天气和废气的影。
- 将进气口对准风向。
- 检查管道上是否有扭结或断裂。如果有损坏，请更换。



警告: 只能使用内部有钢编织加固的柔性管道，以防止扭结和随之而来的横截面缩小。不要吸食有害气体或废气。

5.3.3 电气连接

压缩机提供了一条电线。要连接到电源上，只需将插头插入主电源插座。检查压缩机ID板上的数据是否与主电源兼容，特别是在额定电流和电压方面。主电源系统必须有一个有效的地线（接地）；检查接地电阻值是否符合压缩机电气系统的保护/操作要求。

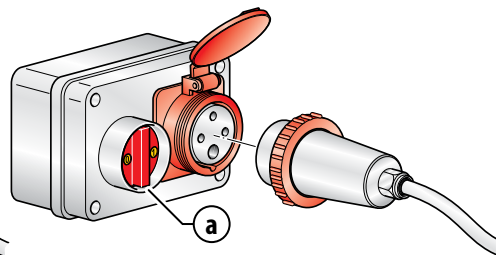

警告: 在插入插头之前，请检查电气系统是否符合安装国的现行标准。适当的接地（地线）系统是必要的安全条件。有效的压缩机接地（地线）系统是必不可少的压缩机安全条件。主电源连接插头必须是符合相关标准的型号认证，并有一个ON-OFF (a) 开关（不提供）。
危险: 检查主电源的特性是否与压缩机的特性相符。



6 - USING THE COMPRESSOR



IMPORTANT: for optimal use of the compressor is recommended to respect the times of continuous use, and the shutdown time (for cooling) reported in the table.

Engine power (Kw) 发动机功率(Kw)	Use (minutes) 使用 (分钟)	Cooling (minutes) 冷却 (分钟)
4 (ET)	80	20
5,5 (ET)	90	25

6.1 PRELIMINARY CHECKS BEFOR USING FOR THE FIRST TIME

The operator must check that the compressor is supplied with:
- use and maintenance manual;

If the compressor is sold on the customer/user must provide the purchaser with a complete, undamaged use and maintenance manual.

6.1.1 Inserting filtration cartridge

At the time of delivery the compressor has no filtration cartridge fitted: the cartridge is supplied together with the compressor in a sealed vacuum-packed bag found inside the packaging.

For instructions on how to insert the filtration cartridge see section "7.8 Purifier filter".

6.1.2 Checking for proper electrical connection (for three-phase electric motors only)

Check for proper connection of electrical phases by checking that the cooling fan rotates in the direction indicated on the label (a) on the fan cover.

If the direction of rotation is not as indicated by the arrow it will be necessary to disconnect the electrical power supply and invert two of the three phases on the main power lead.



DANGER: Before carrying out this task disconnect the compressor from the mains power supply.
Do not invert or disconnect the ground (earth) wire (yellow/green).



6 - 使用压缩机

重要提示: 为了优化压缩机的使用, 建议遵守表格中报告的连续使用时间和停机时间 (用于冷却)。

6.1 在使用前进行初步检查。

操作员必须检查压缩机的供货情况。

- 使用和维护手册。

如果压缩机被出售, 客户/用户必须向购买者提供一份完整的、未损坏的使用和维护手册。

6.1.1 插入过滤筒

在交付时, 压缩机没有安装过滤芯: 过滤芯与压缩机一起放在包装内的密封真空包装袋中。(调试, 已安装)。

关于如何插入过滤芯的说明, 见 "7.9 净化器过滤器" 一节。

6.1.2 检查电气连接是否正确(仅适用于三相电动马达)

通过检查冷却风扇是否按照风扇盖上标签 (a) 上指示的方向旋转, 检查电气相位是否正确连接。

如果旋转方向与箭头所示不同, 则有必要断开电源, 将主电源线上的三相中的两相反转。



危险: 在执行这项任务之前, 请将压缩机与主电源断开。

不要颠倒或断开地线 (黄色/绿色)。



ATTENTION: only invert the phase cables on the plug. Never modify the electrical system of the control panel or of the motor.

The air flow generated by the fan must be directed towards the compressor and not outwardly.



注意: 只能将插头上的相线反转。切勿修改控制板或电机的电气系统。

风扇产生的气流必须吹向压缩机, 而不是向外。

6.1.3 Refill hoses connection

At the time of delivery the compressor has no refill hoses fitted: the refill hose is supplied together with the compressor inside the packaging.

For instructions on connection see section "7.10 Hose replacement".

6.1.3 加注软管连接

在交付时, 压缩机没有安装加注软管: 加注软管与压缩机一起在包装内提供。

有关连接说明, 请参见 "7.10 软管更换" 一节。

6.2 CHECKS TO BE RUN AT THE START OF EACH WORKING DAY

Inspect the exterior of the compressor (couplings, pipes, pneumatic components etc.) and check for any oil leaks.

6.2.1 Lubricating oil level check

Check that the lubricating oil level (a) is within acceptable limits (MIN.-MAX.).

Note that an excessive quantity of oil can cause infiltrations in the cylinders and leave deposits on the valves while too low a level prevents proper lubrication and could cause engine seizure.

If the oil level is not within the minimum and maximum limits top up or drain as described in section "7.9 Changing the lubricating oil".



6.2 工作日开始时的检查

检查压缩机的外部（联轴器、管道、气动元件等），检查是否有漏油。必要时更换部件或联系厂家售后。

6.2.1 润滑油油位检查

检查润滑油油位 (a) 是否在可接受的范围内 (下限MIN-上限MAX)。需要注意的是，过量的机油会导致气缸内的渗透，并在气门上留下沉积物，而过低的机油水平则会妨碍适当的润滑，并可能导致压缩机被卡死。

如果油位不在最低和最高限度内，请按照 "7.10 更换润滑油" 一节中的描述进行加油或放油。

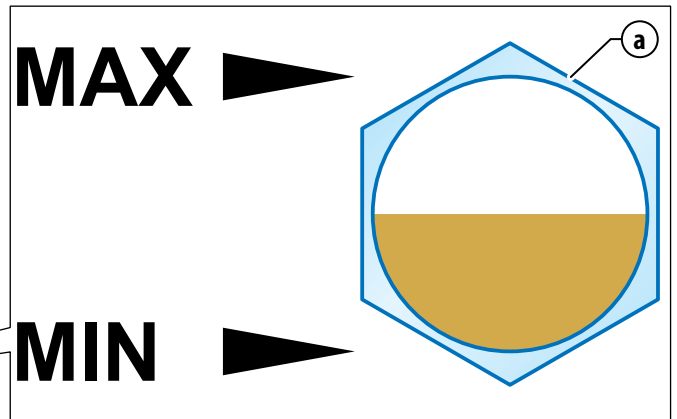

6.2.2 Storing technical documentation

The use and maintenance manual and its appendices must be stored carefully and must always be kept where they can be accessed easily for immediate consultation.



WARNING: The use and maintenance manual is an integral part of the compressor and must always be handed over in the event of a change of ownership.

6.2.3 Checking that the refill flex hoses are in good condition

Inspect the refill hoses and make sure there are no cuts, holes, abrasions, leaks etc. If necessary replace with new hoses.

6.2.2 储存技术文件

使用和维护手册及其附录必须小心保存，并且必须始终保存在可以方便查阅的地方以便立即查阅。



警告：使用和维护手册是压缩机不可分割的一部分，在所有权发生变化时必须始终移交。

6.2.3 检查加注软管是否处于良好状态







检查加注软管，确保没有切口、孔洞、擦伤和泄漏等。如果有必要，请更换新的软管。

6.2.4 Checking the safety valves

The final safety valve protects bottles and the compressor by excessive pressure; the valve setting is made at the time of testing the compressor. The safety valve are pre-adjusted to:

6.2.4 检查安全阀

最终安全阀通过过压保护瓶子和压缩机；在测试压缩机时进行阀门设置。安全阀预调整为：

NOMINAL OPERATING PRESSURE - 工作压力	STICKER - 标签	SAFETY VALVE - 安全阀
232 bar 3300 PSI	 ADESIVO/232	 6-05-015/3/232
300 bar 4300 PSI	 ADESIVO/300	 6-05-015/3/300
330 bar 4700 PSI	 ADESIVO/330	 6-05-015/3/330

The safety valve must be tested every 250 working hours of the compressor.

To check the safety valve:

- set the pressure to a pressure higher than that of the valve setting;
- after attaching the coupling to the bottle start the compressor with the bottle valves closed;
- once you have checked, using the gauge, that the safety valve trips properly at maximum working pressure.

压缩机每工作250小时必须对安全阀进行检测。

要检查安全阀:

- 将压力设置为高于阀门设置的压力。
- 将接头连接到瓶子上后，在瓶子阀门关闭的情况下启动压缩机。
- 使用压力表检查安全阀是否在最大工作压力下正常跳动。

 **IMPORTANT:** The safety valves must be replaced every 10 years or 5000 hours.

 **DANGER:**
Tampering with the safety valve to increase the pressure setting is strictly forbidden.
Tampering with the safety valve can seriously damage the compressor, cause serious injury to personnel and renders the warranty null and void.

Should the safety valve fail to work properly contact the assistance service.

 **要提示:** 安全阀必须每10年或5000小时更换一次。
危险:
严禁篡改安全阀以提高压力设置。

 篡改安全阀会严重损坏压缩机，对人员造成严重伤害，并使保修失效。

如果安全阀不能正常工作，请联系售后援助服务。

6.3 CONTROL PANEL (OPTIONAL)



WARNING: It is forbidden to alter pressure parameters without authorisation
Any unauthorised modifications shall render the warranty null and void.

IMPORTANT: If malfunction situations occur in the command device or control devices,

1 Automatic shutdown pressure switch

The automatic shutdown pressure switch determines the compressor shutdown pressure.

The shutdown pressure can be set via the regulator (a) and displayed via the indicator (b). When the compressor reaches the set pressure it shuts down automatically.

The compressor can reach a maximum pressure of 232-300-330 bar (3300-4300-4700 PSI).

2 Manual condensate discharge button

Pressing the yellow manual condensate discharge button drains the condensate collected in the special recipient during use of the compressor (no further tasks required: drainage interval managed with the pressure switch timer). To drain the condensate see section "7.6 Condensate discharge".

3 ON pushbutton

To start the compressor press the green ON pushbutton. The compressor will then run until the pressure that has been set on the adjustable pressure switch is reached or until the safety valve release over pressure.

4 OFF pushbutton

Press the red OFF pushbutton to stop the compressor.

5 Emergency pushbutton

The emergency pushbutton it must be used in danger or emergency situations. Pressing the pushbutton shuts down compressor operation and the pushbutton remains press-locked; to reset the pushbutton rotate it anticlockwise.

Check that the emergency pushbutton is working properly at the start of each working day.



WARNING: IT IS ABSOLUTELY FORBIDDEN TO TAMPER WITH THE EMERGENCY PUSHBUTTON.

If the compressor fails to shut down immediately after pressing the emergency pushbutton disconnect the compressor from the power supply and contact.

6 Hour counter

The hour counter indicates the number of working hours of the compressor: this provides a time reference for scheduled maintenance.

7 Selector switch ON/OFF

Turning the selector switch to the ON position powers the compressor. Turning the selector switch to the OFF position cuts power to the compressor.

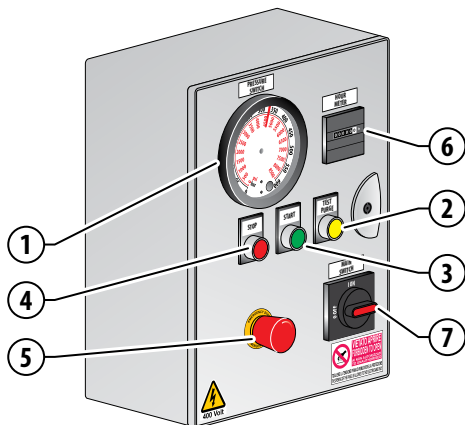

6.3 控制面板 (可选)



警告: 未经厂家授权, 严禁改变压力参数。
任何未经授权的修改都将导致保修无效。

重要提示: 如果命令设备或控制设备出现故障情况, 请联系售后。

1 自动停机的压力开关

自动停机压力开关决定了压缩机的关机压力。

关机压力可以通过调节器 (a) 设定, 并通过指示灯 (b) 显示。当压缩机达到设定的压力时, 它会自动关闭。

压缩机的最大压力可以达到232-300-330巴 (3300-4300-4700 PSI)

2 手动冷凝水排放按钮

按下黄色的手动冷凝水排放按钮可以排放排出在使用压缩机时收集在特殊容器中的冷凝水。不需要进一步的工作: 排水时间间隔由压力开关定时器管理。无需进一步的工作: 用压力开关定时器管理排水间隔)。排除冷凝水的方法见"7.6节冷凝水排放"。

3 开启按钮

要启动压缩机, 请按绿色的"开启"按钮。然后, 压缩机将运行, 直到达到可调节压力开关上设定的压力, 或者直到安全阀释放超压。

4 关闭按钮

按下红色的"关闭"按钮, 压缩机停止工作。

5 紧急按钮

紧急按钮必须在危险或紧急情况下使用。按下该按钮可以关闭压缩机的运行, 并且该按钮一直被按下锁定; 要重置该按钮, 请逆时针旋转该按钮。

在每个工作日开始时, 检查紧急按钮是否正常工作。



警告: 绝对禁止篡改紧急按钮。

如果压缩机在按下紧急按钮后未能立即关闭, 请将压缩机与电源断开, 并联系售后。

6 计时器

计时器指示压缩机的工作小时数: 这为定期维护提供了时间参考。

7 选择器开关 ON/OFF

将选择器开关转到ON (接通) 位置可为压缩机供电。将选择器开关转到OFF (断开) 位置将切断压缩机的电源。

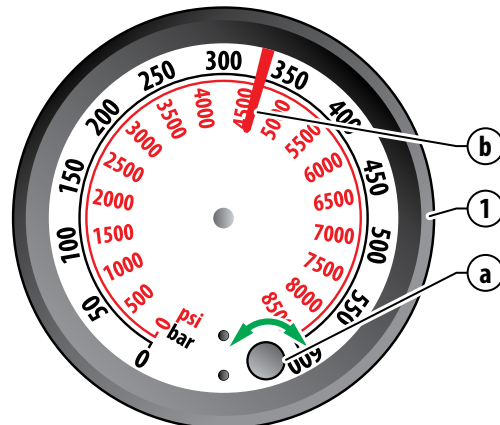

6.4 STARTING AND SHUTTING DOWN

IMPORTANT: These tasks must be carried out by qualified personnel who have been trained to use the compressor.

SMART MCH-8-11/EM

- Before starting the engine open the condensate discharge points (a) to prevent a "strained" start;
- press the start pushbutton (b);
- close the condensate discharge points (a).

To switch off the compressor press the pushbutton (c).

SMART MCH-13-16/ET

- Before starting the engine open the condensate discharge points (a) to prevent a "strained" start;
- turn the socket switch (d) to its ON position;
- close the condensate discharge points (a).

To switch the motor off again turn the socket switch (e) to its OFF position.

EM-ET SMART with CONTROL PANEL

- Before starting the engine open the condensate discharge points (a) to prevent a "strained" start;
- turn the selector (l) in the ON position;
- press the start pushbutton (f);
- close the condensate discharge points (a).

To switch off the compressor press the pushbutton (g).

In any case the compressor will shut down automatically on reaching the pressure set on the pressure switch (i).

6.4 启动和关闭

重要提示: 这些工作必须由经过培训的合格人员来执行, 以使用压缩机。

SMART MCH-8-11/EM

- 启动压缩机前, 打开冷凝水排放点 (a), 以防止“勉强”启动;

- 按下启动按钮 (b);
- 关闭冷凝水排放点 (a)。

要关闭压缩机, 按下按钮 (c)。

SMART MCH-13-16/ET

- 启动压缩机前, 打开冷凝水排放点 (a), 以防止“勉强”启动;
- 将插座开关 (d) 转到接通位置;
- 关闭冷凝水排放点 (a)。

要再次关闭电机, 请将插座开关 (e) 转到其关闭位置。

EM-ET SMART 控制面板

- 起压缩机前, 打开冷凝水排放点 (a), 以防止“勉强”启动;
- 将选择器 (l) 转到接通位置;
- 按下启动按钮 (f);
- 关闭冷凝水排放点 (a)。

要关闭压缩机, 按下按钮 (g)。

在任何情况下, 当达到压力开关 (i) 上设定的压力时, 压缩机将自动关闭。

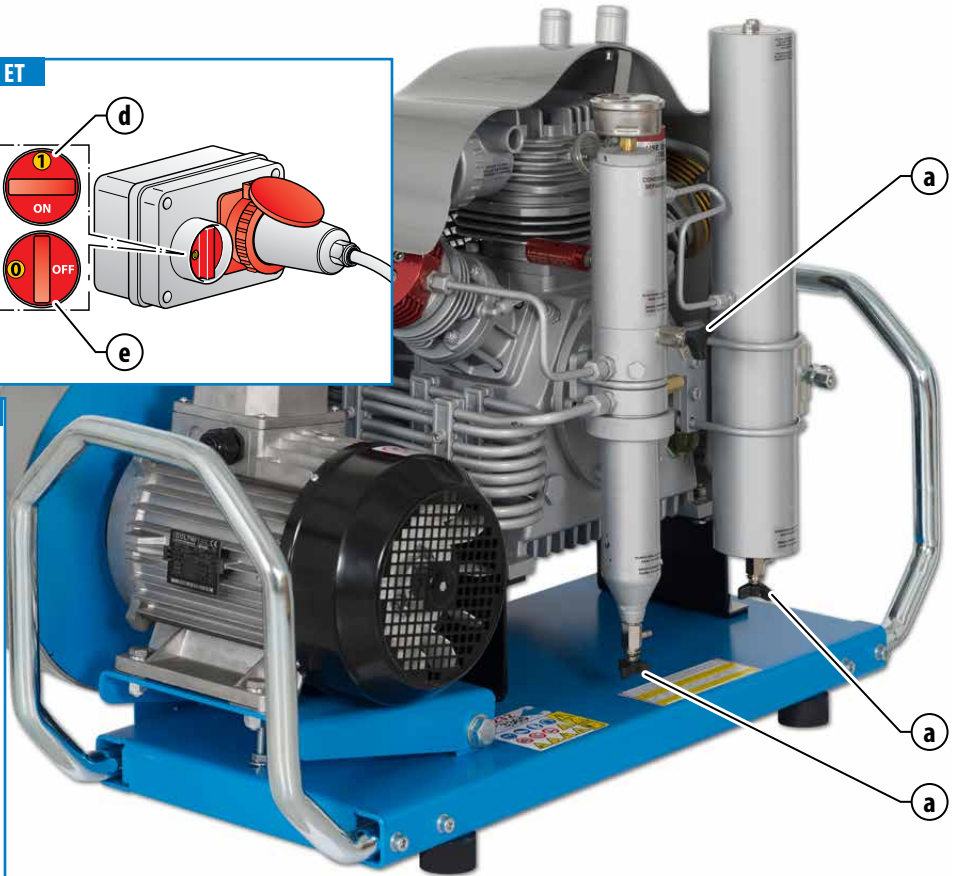
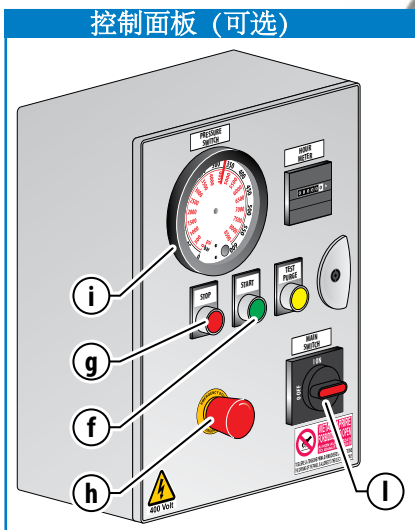
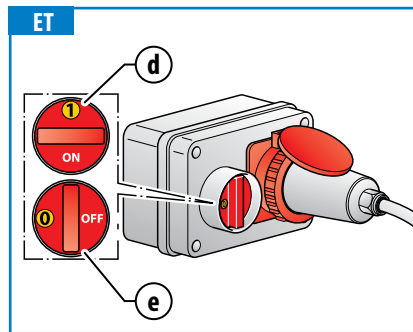
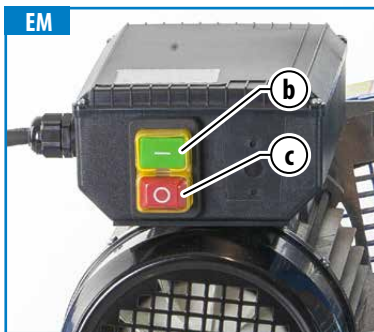

WARNING: If emergency or danger situations occur press the emergency pushbutton (h). To restore normal compressor operation rotate the emergency pushbutton anticlockwise (h).





警告: 如果发生紧急或危险情况, 按下紧急按钮 (h)。要恢复正常压缩机操作, 逆时针旋转紧急按钮 (h)。

6.5 TANK REFILL

6.5 容器加注

 **IMPORTANT:** During refill the operator must be in the work area.

 要提示：在加注过程中，操作人员必须在工作区域内。

 **WARNING:** During bottle refill those not involved in the refill procedure must maintain a safety distance of at least 3 metres. Also, it is forbidden to disconnect the hoses from the fittings or the fill valve while the machine is under pressure.

 **警告：**在瓶子加注过程中，没有参与加注的人必须保持至少3米的安全距离。另外，当机器处于压力状态时，禁止将软管从接头处或加注阀处断开。

 **IMPORTANT:** If an emergency situation arises during refill shut down the compressor immediately (see "6.4 Starting and shutting down"). The compressor is nevertheless equipped with a safety system that shuts it down automatically when:

- Comes into operation the safety valve without shutting down the compressor.
- The pressure setting on the pressure switch has been reached.
- The electrical power supply is temporarily cut.
- The electric motor overload device is tripped.

Following an emergency shutdown always make sure the cause of the emergency has been eliminated before proceeding with another refill.

 **重要事项：**如果在加注过程中出现紧急情况，应立即关闭压缩机（参见“6.4启动和关闭”）。
尽管如此，压缩机还是配备了安全系统，在以下情况下会自动关闭。

- 在不关闭压缩机的情况下，安全阀开始工作。
- 已达到压力开关上的压力设定值。
- 电力供应被暂时切断。
- 电动机过载装置跳闸。
在紧急停机后，一定要确保紧急情况的原因已被消除，然后再继续加注。

 **WARNING:** Use only tested bottles (as proven by a test stamp and/or certificate). The working and bottle refill pressures are shown on the bottles themselves. It is forbidden to refill them at a pressure greater than that indicated.

 **警告：**仅使用经过测试的瓶子（经测试印章和/或证书证明）。
工作压力和瓶子加注压力显示在瓶子上。禁止在高于规定压力的情况下重新加注。

 Check that the bottles to be refilled are in good condition: they must have been tested by the relevant authorities (stamped and/or certified). Run a visual check on the exterior.

 检查要重新填充的瓶子是否完好：它们必须经过相关机构的测试（盖章和/或认证）。对外部进行目视检查。

检查加注软管和相关接头是否处于良好状态。

Check that the refill hose and relevant fitting are in good condition.

重新加注后，不要完全清空瓶子，即使是在冬季储存或长时间不活动时也不行：这将阻止湿气进入。

After being refilled do not empty the bottles completely, not even during winter storage or long periods of inactivity: this will stop humidity getting in.

 **DANGER:** Should bottles show evident signs of internal/external corrosion, do not refill them even if they have been tested.

 **危险：**如果瓶子显示出明显的内部/外部腐蚀迹象，即使已经过测试，也不要重新填充。

The available bottle refill connectors are:

可用的瓶子加注接头有：



To refill bottles proceed as follows:

- set the refill pressure on the pressure switch (1) (optional only for EM-ET);
- fit the hose connector (a) to the bottle valve (b);
- screw in the fixing knob (c) until it is completely tightened;
- check that the bleed valve (f) is closed by rotating it clockwise;
- open the valve (d) by rotating it anticlockwise;
- start the compressor;
- open the valve (e) by rotating it anticlockwise;
- when the refill has been completed shut the compressor down;
- close valves (d) and (e) by rotating them clockwise;
- open the bleed valve (f) by rotating it anticlockwise until all the residual air in the fitting has been expelled;
- unscrew the fixing knob (c) by rotating it anticlockwise;
- disconnect the bottle coupling.

按照以下步骤重新加注瓶子：

- 设置压力开关 (1) 上的加注压力 (仅EM-ET可选) ；
- 将软管接头 (a) 安装到瓶阀 (b) 上；
- 拧入固定旋钮 (c) ， 直至完全拧紧；
- 顺时针旋转排气阀 (f) ， 检查其是否关闭；
- 逆时针旋转阀门 (d) ， 打开阀门；
- 启动压缩机；
- 逆时针旋转阀门 (e) ， 打开阀门；
- 重新加注完成后，关闭压缩机；
- 顺时针旋转阀门 (d) 和 (e) ， 关闭阀门；
- 逆时针旋转排气阀 (f) ， 打开排气阀，直到配件中的残余空气全部排出；
- 逆时针旋转固定旋钮 (c) ， 拧松固定旋钮；
- 断开瓶接头。

控制面板 (可选)

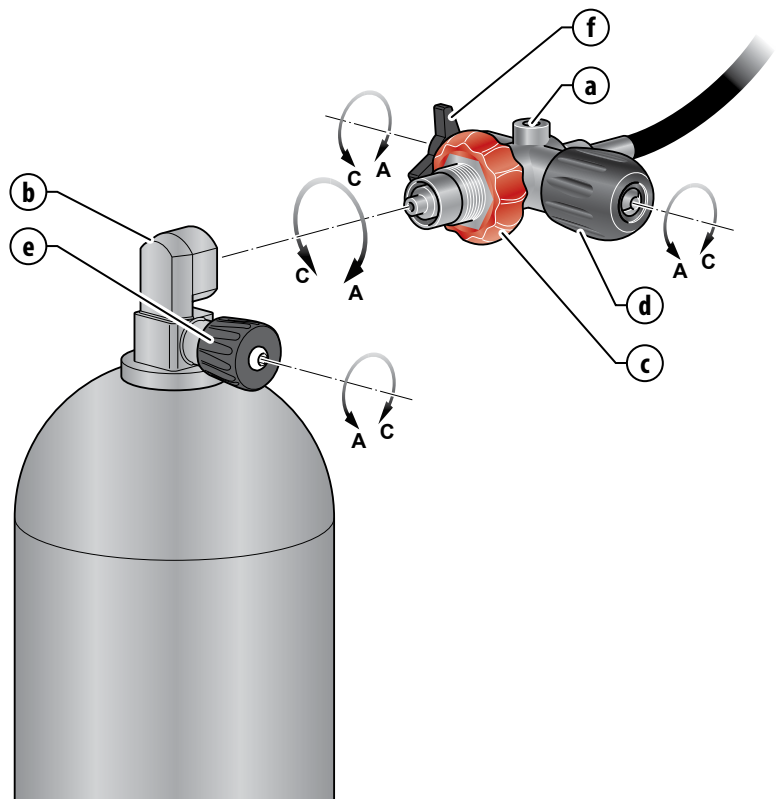
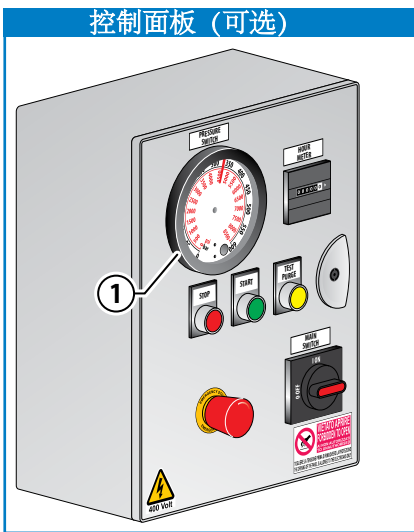

6.6 OPTIONAL

6.6 可选类型

6.6.1 Control panel

6.6.1 控制面板



Code (a)	Voltage 电压	电机类型	自动排污	自动停机 压力表	自动 停机	启停	计时器
SC000500/M/230/60	230 V 60 Hz	单相电	YES	YES	YES	YES	YES
SC000500/M/230/50	230 V 50 Hz	单相电	YES	YES	YES	YES	YES
SC000500/440/60	440 V 60 Hz	三相电	YES	YES	YES	YES	YES
SC000500/400/50	400 V 50 Hz	三相电	YES	YES	YES	YES	YES
SC000500/230/50	230 V 50 Hz	单相电	YES	YES	YES	YES	YES

6.6.2 Automatic shutdown with pressure switch

6.6.2 带压力开关的自动停机

If the compressor is equipped with an automatic shutdown pressure switch (a) it will stop when the pressure set by the manufacturer is reached.

如果压缩机配备有自动停机压力开关 (a)，当达到制造商设定的压力时，压缩机将停止。

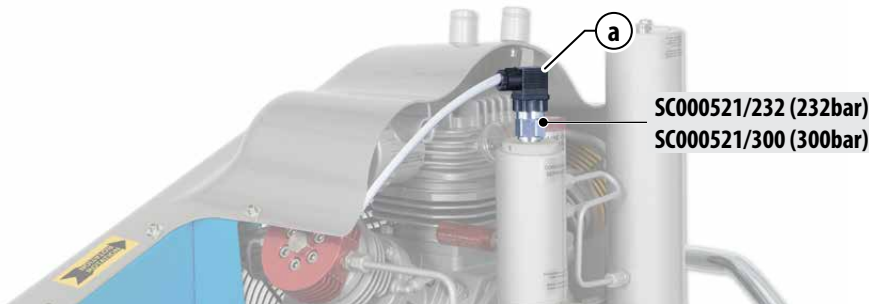

6.6.3 Automatic condensate discharge

6.6.3 冷凝水自动排放

Use a plastic hose to connect the discharge fittings (a) to a recipient/tank for collection of the condensate; check such recipient periodically to prevent it overflowing. If the condensate needs to be unloaded manually, use the discharge taps (b).

使用塑料软管将排放配件 (a) 连接至收集冷凝液的容器/储罐；定期检查收集器，防止其溢出。如果需要手动卸载冷凝液，则使用排放龙头 (b)。

At the end of the refill day, empty the filter condensate using the discharge tap (c).

在加注日结束时，使用排放龙头 (c) 排空过滤器冷凝液。

The condensate must be disposed of as per the instructions given in section "9.1 Waste disposal".

冷凝液必须按照第9.1节“废物处理”中给出的说明进行处理。

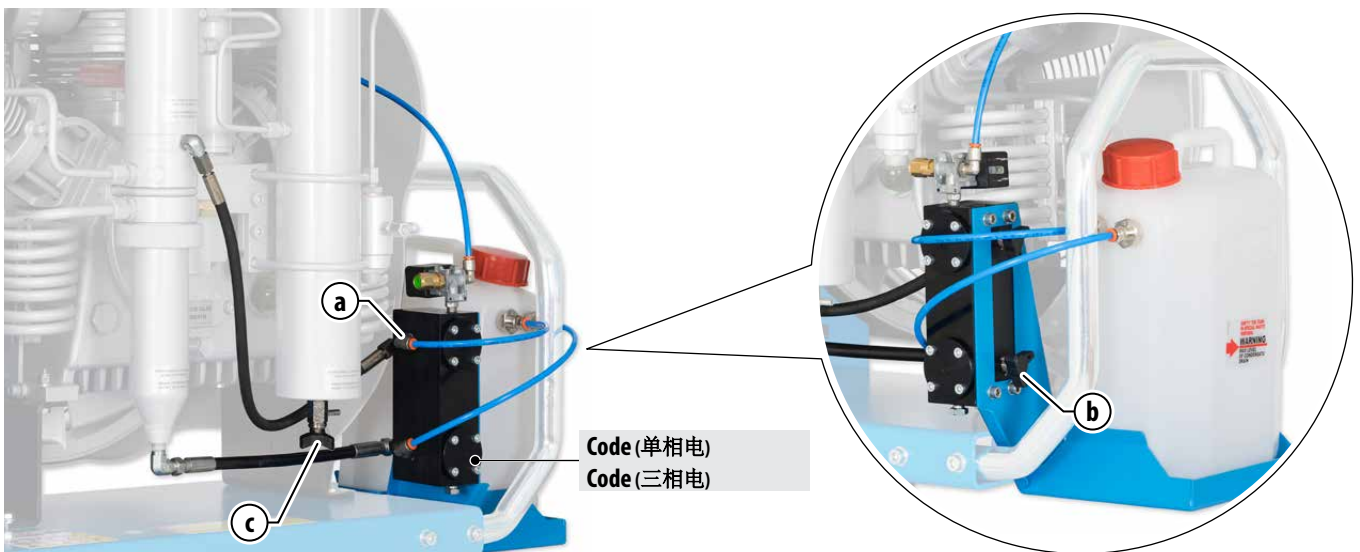

6.6.5 Filling connections

6.6.5 充气接头



6.6.6 Filling hoses

6.6.6 充气软管



Code (a)	Length
SC000461/1500/AIR	1,5 m
SC000461/2000/AIR	2 m
SC000461/3000/AIR	3 m
SC000461/4000/AIR	4 m
SC000461/5000/AIR	5 m
SC000461/8000/AIR	8 m
SC000461/10000/AIR	10 m

6.6.7 C_MONITOR monitoring system (optional)

OIL AND FINAL FILTER MONITORING SYSTEM

The interface consists of an LCD display, a button (i) and two indicators (●, ○). The decimal points next to the digits are lights to indicate alarms or warnings in progress. Each dot is associated with an explanatory icon (🔋%, 🛢️%, 🛢️%). The symbol (●) indicates an alarm condition while the symbol (○) indicates normal operation.

Press the button (i) to scroll through the various menu functions. When pressed, the function is displayed and the relative data after two (2) seconds. The sequence of functions is as follows:

SALE Cartridge Saturation (expressed as a percentage)

If the saturation falls below 20%, the alarm (●) is activated and the indicator (dot) lights up at the icon 🛢️%. After replacing the cartridge, by pressing the button for at least three (3) seconds (i) while the corresponding menu is displayed, the alarm is reset and the value returns to 100%. The alarm indicator at the icon 🛢️% is deactivated and only the symbol (○) remains active.

Hour Hours of operation

When the value "9999" is passed, the counter automatically returns to "0000". Detection of operating hours takes place through the vibration sensor contained within the C_Monitor.

BATT Battery charge level (expressed as a percentage)

When the level drops below 50%, the alarm (●) is activated and the indicator (dot) lights up at the icon 🔋%. After replacing the battery, the alarm automatically resets and the alarm indicator next to the icon 🔋% turns off and only the symbol (○) remains active.

Changing the battery does not result in the loss of other information or settings.

SERH Service (expressed in hours)

It indicates the hours remaining before replacement of the lubricating oil is required. When the value reaches zero (0), the alarm (●) is activated and the indicator (dot) lights up at the icon 🛢️%. After performing the maintenance, pressing the button (i) for at least three (3) seconds while the corresponding menu is displayed, the alarm is reset and the maintenance counter is reset. The alarm indicator, at the icon 🛢️%, is deactivated and only the symbol (○) remains active.

BATTERY CHANGE

Open the cover of the C_Monitor using the four screws (a) present. Disconnect the connector (b), remove the depleted battery (c) replacing it with the new one, being sure to fix it to the electronic board using double-sided adhesive tape, reconnect the connector (a) in the dedicated slot and close the cover.

Changing the battery does not result in the loss of other information or settings. The average life of the battery is approximately 1 year.

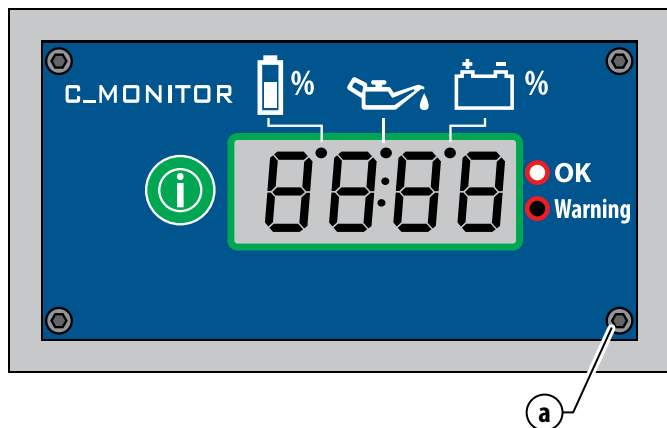

6.6.7 C_MONITOR监控系统

机油和最终过滤器监测系统

界面由一个液晶显示器、一个按钮 (i) 和两个指示灯 (●, ○) 组成，数字旁边的小点是指示灯，用于指示正在进行的报警或警告。每个点都与一个解释性图标 (🔋%, 🛢️%, 🛢️%) 相关联。符号 (●) 表示报警状态，而符号 (○) 表示正常运行。

按下按钮 (i) 可滚动浏览各种菜单功能。长按两 (2) 秒后显示功能和相关数据。

功能顺序如下：

SALE 滤芯饱和度 (以百分比表示)

如果饱和度降到20%以下，●警报将激活，🛢️%图标处的指示灯 (点) 亮起。更换滤芯后，在显示相应菜单的同时按下按钮 (i) 至少三 (3) 秒，警报将重置，数值将返回100%。图标上的报警指示灯🛢️%被禁用，只有符号○保持激活状态。

Hour 运行时间

当传递值“9999”时，计数器自动返回“0000”。工作时间的检测是通过C_Monitor监视器内的振动传感器进行的。

BATT 电池电量 (以百分比表示)

当液位降到50%以下时，●警报启动，🔋%图标处的指示灯 (点) 亮起。更换电池后，警报自动重置，🔋%图标旁边的警报指示灯熄灭，只有○符号保持激活状态。更换电池不会导致其他信息或设置丢失。

SERH 维保 (以小时表示)

表示需要更换润滑油前的剩余时间。当值达到零 (0) 时，●警报被激活，🛢️%图标处的指示灯 (点) 亮起。执行维护后，按下按钮 (i) 至少三 (3) 秒，同时显示相应的菜单，重置警报并重置维护计数器。🛢️%图标处的报警指示灯被禁用，只有○符号保持激活状态。

更换电池

使用现有的四个螺钉 (a) 打开C_Monitor显示器的盖子。断开连接器 (b)，取下耗尽的电池 (c)，更换新电池，确保使用双面胶带将其固定到电子板上，将连接器 (b) 重新连接到专用插槽中，然后合上盖子。

更换电池不会导致其他信息或设置丢失。电池的平均寿命约为1年。

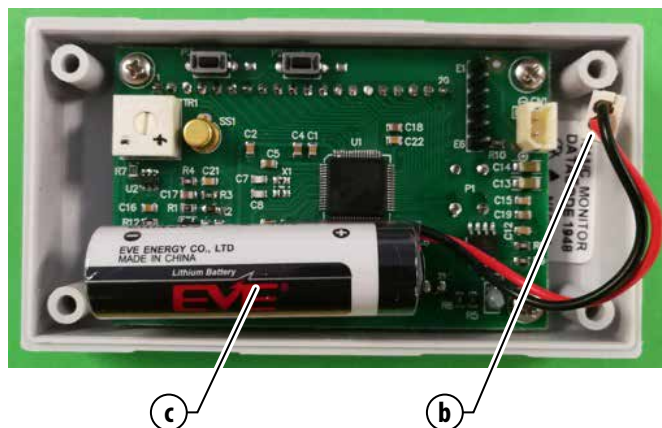

7 - MAINTENANCE



WARNING: Maintenance tasks must only be carried out by the Customer Assistance Service or qualified personnel.



DANGER: Do not carry out maintenance tasks if the compressor has only just shut down; wait for the compressor to cool.

All maintenance work must be carried out with the compressor OFF and the power supply lead unplugged from the mains socket.

Depressurise the entire compressor circuit before carrying out any maintenance tasks.

To depressurise the entire compressor circuit open the drain valves (a).

7 - 维护



警告: 维修任务只能由厂家客户援助服务部或合格人员进行。



危险: 如果压缩机刚刚关闭, 不要进行维护工作; 要等待压缩机冷却。

所有维护工作必须在压缩机关闭、电源线从电源插座上拔下的情况下进行。

在执行任何维护任务之前, 要对整个压缩机回路减压。

要对整个压缩机回路降压, 请打开排放阀 (a)。



7.1 FOREWORD

To obtain the best possible performance from the compressor and ensure a long working life for all its parts it is essential that personnel follow the use and maintenance instructions with extreme diligence.

It is thus advisable to read the information below and consult the manual every time an inconvenience arises.

For further information please contact our assistance centre:

7.1 前言

为了使压缩机获得尽可能好的性能, 并确保其所有部件具有较长的使用寿命, 工作人员必须极其谨慎地遵守使用和维护说明。

因此, 每次出现不便时, 建议阅读以下信息并查阅手册。

有关更多信息, 请联系我们的援助中心:

7.2 GENERAL

- Proper preservation of the compressor requires thorough cleaning.
- This type of refill station, designed and built according to the most advanced technological criteria, requires only minimum preventive and routine maintenance.
- Before carrying out any maintenance tasks, run checks and/or controls on the compressor, switch off the compressor, remove the plug from the mains socket.
- The residual pressure present in the compressor (pumping circuit) must be released.
- During disassembly and re-assembly of the compressor, always use suitable wrenches/tools so as not to damage the relevant components.
- Loosen stiff parts with a copper or plastic mallet.
- When refitting parts make sure they are clean and lubricated sufficiently.
- Compressor maintenance tasks must only be carried out by authorised personnel and recorded in the chapter "10 Maintenance register" of this manual.

7.2 概述

- 压缩机的适当保存需要彻底清洁。
- 这种加气站是根据最先进的技术标准设计和建造的, 只需要最低限度的预防和日常维护。
- 在执行任何维护任务之前, 对压缩机进行检查和/或控制, 关闭压缩机, 从电源插座上拔下插头。
- 必须释放存在于压缩机(泵送回路)中的残余压力。
- 在拆卸和重新组装压缩机时, 一定要使用合适的扳手/工具, 以免损坏相关部件。
- 用铜锤或塑料锤来松开坚硬的部件。
- 在重新安装部件时, 要确保它们是干净的, 并得到充分的润滑。
- 压缩机的维护工作只能由经授权的人员进行, 并记录在本手册的"10 维护登记"一章中。

7.3 UNSCHEDULED WORK

Involves repair and/or replacement of the mechanical parts of one or more compressor components: this work normally needs doing only after some years of use. If substantial modifications are made, the manufacturer cannot be held liable for any dangers that might arise. This work must be carried out by the assistance centre.

7.3 计划外工作

涉及维修和/或更换一个或多个压缩机部件的机械零件：通常只有在使用几年后才需要进行这项工作。如果进行了大量的修改，制造商不能对可能出现的任何危险负责。这项工作必须由援助中心来完成。

7.4 SCHEDULED MAINTENANCE TABLE

7.4 定期维护表

Before every refill - 每次使用前 Maintenance - 维保	Hours - 小时												Years - 年数			
	25	50	100	250	500	1000	1500	2000	3000	4000	5000	20000	1	5	10	15
Condensate discharge (change sintered filter) 冷凝水排放 (更换烧结过滤器)	○			●												
Intake filter 进气过滤器		○		●									●			
Lubricating oil + oil filter (if present) 润滑油+机油滤清器 (如有)	○				●								●			
Belt wear and tension 皮带磨损和张紧				○	●								●			
1 st , 2 nd stage valves 一、二级阀门						●										
3 rd stage valves 三级阀门						●										
Separator sintered filter 冷凝水分离器滤芯				○						●						
Condensate separator 冷凝水分离器				○								●				●
HP filter 过滤桶				○								●				●
1 st , 2 nd stage piston rings 一、二级活塞环								●								
3 rd stage complete 三级缸整套						●										
HP flex hoses 高压软管		○								●				●		
Fitting leakages 密封件检查				○												
Safety valve 安全阀				○							●				●	
Coolers 冷却器										●						

○ = Checking and cleaning ● = Change

○ = 检查并清洁 ● = 更换

 **IMPORTANT:** Maintenance interval times are indicative only and may vary according to the conditions under which the compressor is used. Change o-ring and gasket at every dismantling.

 **重要事项:** 维护间隔时间仅供参考，并可能根据压缩机的使用条件而变化。每次拆卸时更换o形圈和垫圈。

7.5 TROUBLESHOOTING

Problem	Cause	Solution
• The electric motor does not start	• Phase missing	• Check fuses or condenser
• Rotation speed and flow rate decrease	• Motor power too low	• Check the motor and the line
	• The belt slips	• Restore proper belt tension
• The flow rate diminishes without rpm decreasing	• Valves not working	• Contact technical assistance
	• 3rd stage piston worn	• Contact technical assistance
	• Fittings loose / leaking seals	• Check for leaks with soapy water and eliminate them
	• Intake filter clogged	• Replace
	• Intake extension kinked	• Straighten, use stiffer pipe
	• Piston or piston rings worn	• Contact technical assistance
• Air smells of oil	• Filter cartridge exhausted	• Replace
	• Piston rings worn	• Contact technical assistance
• Compressor overheats	• Direction of rotation wrong	• Correct direction of rotation
	• Cooling tubes dirty	• Contact technical assistance
	• Incomplete valve closure (causing overload of another stage)	• Contact technical assistance

7.5 故障排除

Problema	Causa	Rimedio
电动机不能启动	缺相	检查保险丝和冷凝器
• 转速和流量降低	• 电机功率过低	• 检查电机和线路
	• 皮带打滑	• 恢复正确的皮带张力
• 在转速没有下降的情况下，流量会减少	• 阀门不工作	• 联系技术支持
	• 第三级活塞磨损	• 联系技术支持
	• 配件松动/ 泄漏的密封件	• 用肥皂水检查泄漏并消除
	• 进气过滤器堵塞	• 更换
	• 进气延长扭结	伸直，使用较硬的管道
	• 活塞或活塞环磨损	• 联系技术支持
• 空气中有油的气味	• 滤芯饱和	• 更换
	• 活塞环磨损	• 联系技术支持
• 压缩机过热	• 旋转方向错误	• 调整正确的旋转方向
	• 冷却管脏	• 联系技术支持
	• 阀门关闭不全(造成另一段过载)	• 联系技术支持

7.6 CONDENSATE DISCHARGE



DANGER: Do not carry out these tasks if the compressor has only just shut down; wait for the compressor to cool. All maintenance work must be carried out with the compressor OFF and the power supply lead unplugged from the mains socket.

Condensation accumulates in the condensate separator and in the filter; the condensate must be discharged every 10-15 minutes of compressor use.

To discharge the condensate open the drain valves (a1, a2, a3) in sequence and collect the condensate in an appropriate recipient. Close the valves.



For compressors with automatic condensate discharge the condensate discharge occurs automatically every 7 minutes. The yellow TEST PURGE pushbutton (b) must be pressed every day to make sure that the discharge valve is working properly.

The condensate is collected in a can (c); periodically check this can to prevent overflow and consequent leakage of the condensate liquid. To empty the can remove the condensate drain hoses (d), empty the can and collect the condensate in a container; re-insert the hoses (d) and put the can back in its housing.

If the condensate needs to be drained manually, use the drain taps (a) and collect the condensate in a suitable container. Re-close the taps.

Every 250 hours replace the SINTERED FILTER (e). An outflow of condensate water with lubricating oil is normal during refills: the quantity will depend on the level of humidity in the air.

7.6 冷凝水排放



危险: 如果压缩机仅关闭，请勿执行这些任务；等待压缩机冷却。

所有维护工作必须在压缩机关闭且电源线从电源插座拔下的情况下进行。

冷凝液积聚在冷凝液分离器和过滤器中；压缩机使用后，冷凝液必须每10-15分钟排放一次。

为了排放冷凝液，依次打开排水阀（a1、a2、a3），并将冷凝液收集到适当的容器中。关闭阀门。

对于具有自动冷凝水排放的压缩机，冷凝水排放每7分钟自动进行一次。每天必须按下黄色测试按钮（b），以确保排放阀正常工作。

冷凝液收集在罐（c）中；定期检查此罐，以防止过量加注和冷凝液泄漏。要排空收集器，拆下冷凝水排放软管（d），将冷凝水收集到容器中；重新插入软管（d）并将收集器放回壳体中。

如果需要手动排放冷凝液，请使用排污阀（a）并将冷凝液收集到适当的容器中。重新关上排污阀。

每250小时更换一次烧结过滤器（e）。在加注过程中，冷凝水和润滑油的流出是正常的：流出量取决于空气中的湿度水平。

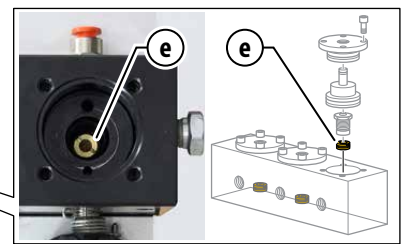
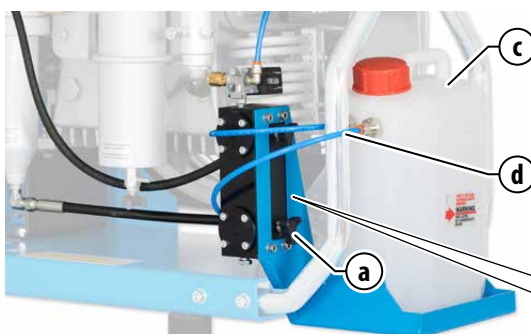
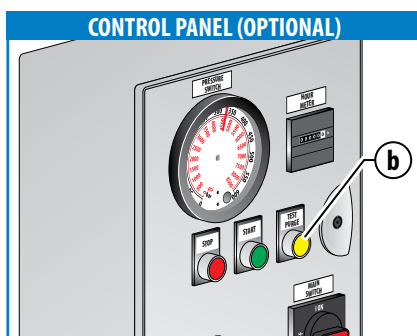

IMPORTANT: Condensate must be disposed of according to the instructions shown in section "9.1 Waste disposal".

IMPORTANT: Every 15 years or ever 20000 hours it will be necessary to change the condensate separator body.

IMPORTANT: Every 5 years or ever 3000 hours it will be necessary to change the drain valves.

DANGER: You MUST drain the condensate at the specified intervals. Failure to observe this instruction can place staff in serious danger and could cause serious damage or injury.

警告: 冷凝液必须按照第9.1段废物处理中的说明进行处理。

重要事项: 每隔15年或20000小时，必须更换冷凝液分离器体。

重要事项: 每隔5年或3000小时，必须更换排放阀。

危险: 必须按规定的时间间隔排放冷凝液。不遵守本说明可能会使员工处于严重危险中，并可能造成严重损坏或伤害。

7.7 CHANGING THE INTAKE FILTER



DANGER: Do not carry out these tasks if the compressor has only just shut down; wait for the compressor to cool. All maintenance work must be carried out with the compressor OFF and the power supply lead unplugged from the mains socket.

After putting the compressor into service the intake filter must be changed after the first 50 working hours.

The air filter must then be changed every 250 working hours or annually. Rotate the filtration cartridge in the filter by 90° every 50 hours.

To change the filter proceed as follows:

- turn the air filter cover (a) by rotating it anticlockwise;
- remove the air filter cartridge (b);
- replace the cartridge with a new one;
- re-close the cover (a): screw it back on clockwise.

7.7 更换进气滤清器



危险: 如果压缩机刚刚关闭，不要执行这些任务；等待压缩机冷却。所有维护工作必须在压缩机关闭且电源线从电源插座上拔下的情况下进行。

压缩机投入使用后，必须在前50个工作小时后更换进气滤清器。然后必须每250个工作小时或每年更换一次空气滤清器。每50小时将过滤器中的滤筒旋转90°。

要更换过滤器，请按以下步骤进行：

- 逆时针转动空气滤清器盖 (a) ；
- 取下空气滤芯 (b) ；
- 更换新滤芯；
- 重新盖上盖子 (a) ：顺时针拧回。

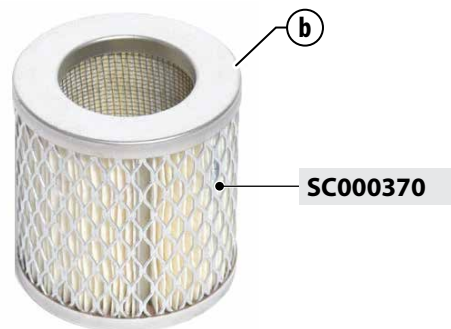
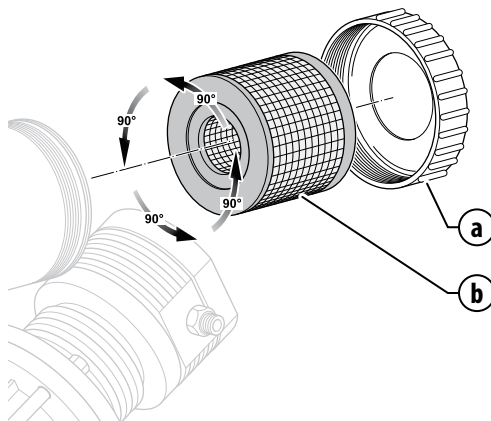
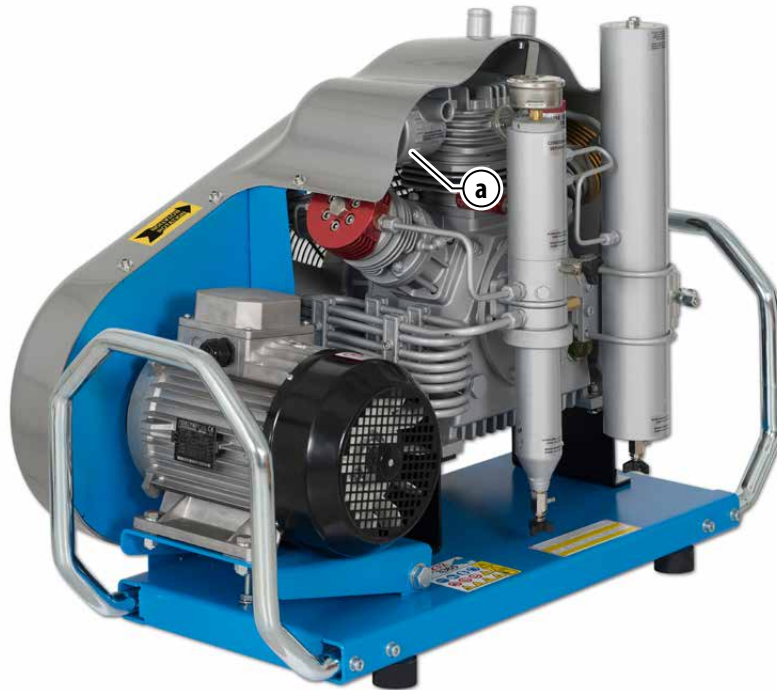

IMPORTANT: If the compressor is used in a dusty environment the filter change interval should be reduced to every 50 hours.



重要事项: 如果压缩机在多尘环境中使用，则过滤器更换间隔应缩短为每50小时一次。

7.8 PURIFIER FILTER

 **WARNING:** Constant and precise maintenance on the components of the filtering system, as described in this manual, guarantees that the quality of the air exiting the compressor is in compliance with the requirements specified by the EN12021 standard.

The filtration cartridge must be replaced at intervals calculated on the basis of the characteristics of the environment in which the compressor is located. To calculate these intervals refer to the table below.

The filter cartridge must in any case be replaced before the air develops an unpleasant smell or when the litmus test (z) inside the cartridge turns white or a colour other than blue.



 **IMPORTANT:** If the compressor is used in an environment where CO (exhaust fumes) may be present it is compulsory to use CO-fixing filtration cartridges; these can be supplied on request.

 **DANGER:** Do not carry out these tasks if the compressor has only just shut down; wait for the compressor to cool. All maintenance work must be carried out with the compressor OFF and the power supply lead unplugged from the mains socket. Depressurise the entire compressor circuit before carrying out any maintenance tasks. To depressurise the entire compressor circuit proceed as follows in the section "7 - Maintenance".

 **DANGER:** You **MUST** replace the filtration cartridge at the specified intervals. Failure to observe this instruction can place staff in serious danger and could cause serious damage or injury.

 **IMPORTANT:** If cartridges are renewed by replacing their internal components it will be necessary to change the outer covering every 10 renewals. Upon each refill, check that the cartridge body is intact and without any defect.

7.8 净化器过滤器

 **警告:** 如本手册所述, 对过滤系统的部件进行持续和精确的维护, 可确保排出压缩机的空气质量符合EN12021标准规定的要求。

必须根据压缩机所处环境的特点计算更换滤芯的间隔时间。要计算这些间隔, 请参阅下表。

在任何情况下, 必须在空气产生难闻气味或滤芯内的石蕊试验 (z) 变为白色或蓝色以外的颜色之前更换滤芯。



 **重要事项:** 如果压缩机在可能存在CO (一氧化碳) 的环境中使用时, 则必须使用CO固定滤芯; 可按要求提供。

 **危险:** 如果压缩机刚刚关闭, 不要执行这些任务; 等待压缩机冷却。所有维护工作必须在压缩机关闭且电源线从电源插座上拔下的情况下进行。在执行任何维护任务之前, 对整个压缩机回路进行减压。要对整个压缩机回路减压, 请按照“7-维护”一节中的步骤进行。

 **危险:** 必须按规定的间隔更换滤芯。不遵守本说明会使员工处于严重危险中, 并可能造成严重损坏或伤害。
重要事项: 如果墨盒是通过更换其内部部件进行更新的, 则每10次更新就必须更换一次外壳。每次加注后, 检查筒体是否完好无损。
警告: 如果使用带冷干机的压缩机, 滤芯的更换间隔可比表中所示的时间长5倍。

Filter cartridge replacement frequency calculation table *				
Temperature 温度		Filter duration (work hours) 过滤持续时间 (工时)		
°C	°F	MCH-8	MCH-11	MCH-13
40	104	14	10	9
30	86	23	17	15
20	68	36	27	23
10	50	54	41	35
0	32	100	75	64
-5	23	159	119	101
		MCH-16		
		7	12	19
		29	53	84

* The values shown in the table were obtained with pressure maintenance valve calibrated at 200bar.
* 表中所示的数值是在压力维持阀校准为200bar时获得的。

 **WARNING:** The filtration cartridge are classified as special waste: they must be disposed of in compliance with the anti-pollution standards in force.

 **IMPORTANT:** It is essential that there be a filtration cartridge (a) inside the purifier filter (h) every time the compressor is used.

 **IMPORTANT:** Every 15 years or every 20,000 hours the filter body (h) and the condensate separator (i) must be replaced.

 **警告:** 滤筒属于特殊废物: 必须按照现行的防污染标准进行处理。

 **重要事项:** 每次使用压缩机时, 必须在净化器过滤器 (h) 内安装过滤芯 (a)。

 **重要事项:** 每15年或每20000小时必须更换一次过滤器体 (h) 和冷凝液分离器 (i)。

Changing the filtration cartridge

To change the filtration cartridge (a) proceed as follows:

- vent all the compressed air inside the circuit;
- use the tool (b) to lever the screw heads (d) on the plug (c) and rotate counter clockwise;
- remove the filter plug (c);
- unscrew the cartridge (a) from the plug (c);
- replace the cartridge (a) with a new one;
- screw the new cartridge (a) onto the plug (c);
- close the filter plug (c) and tighten with the wrench (b).

There are O-rings on the filter plug and cartridge (f-g). If these O-rings deteriorate air is vented through the cap (c).

If you notice any venting replace the O-rings.

When changing the O-rings observe the precautions described at the beginning of the relevant section of the manual.

更换滤芯

要更换滤芯 (a)，请按以下步骤进行：

- 排出回路内的所有压缩空气；
- 使用工具 (b) 撬起螺塞 (c) 上的螺钉头 (d) 并逆时针旋转；
- 取下过滤器塞 (c)；
- 从螺塞 (c) 上拧下滤芯 (a)；
- 用一个全新的滤芯 (a) 更换；
- 将新滤芯 (a) 拧到螺塞 (c) 上；
- 关闭滤清器塞 (c) 并用扳手 (b) 拧紧。

滤清器塞和滤芯 (f-g) 上有O形圈。如果这些O形圈损坏，空气将通过盖 (c) 排出。

如果发现任何排气，请更换O形圈。

更换O形圈时，请遵守本手册相关章节开头所述的预防措施。

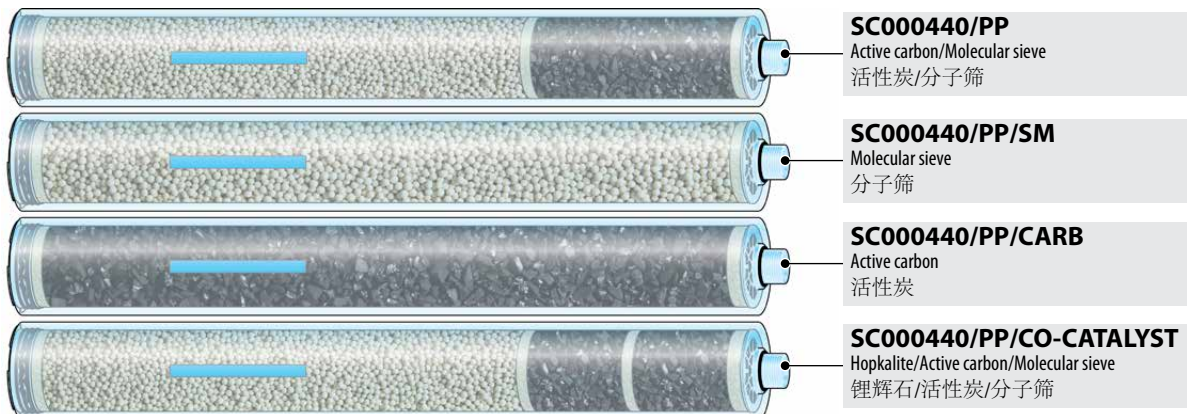
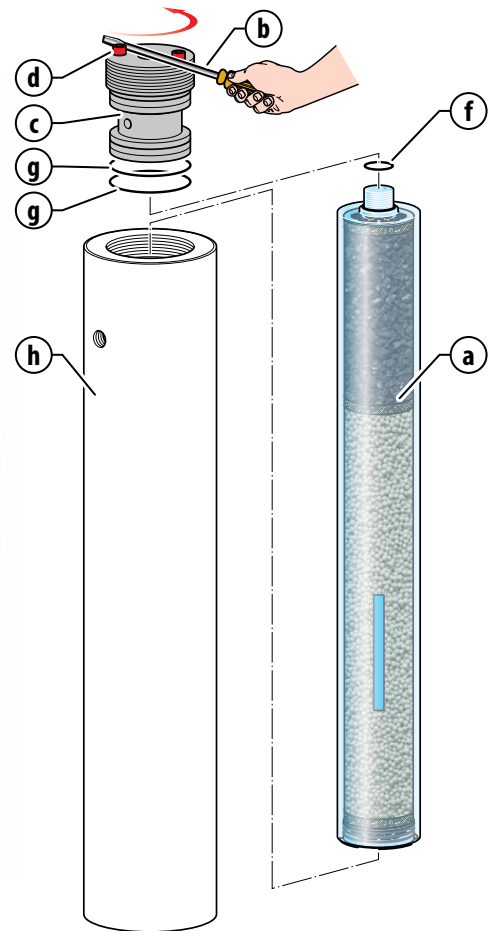
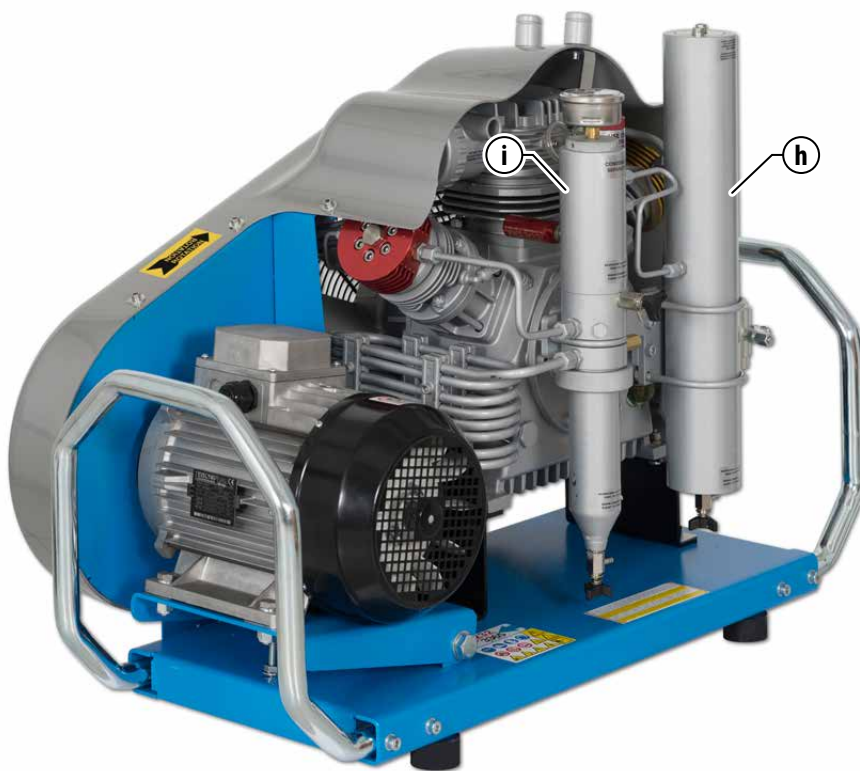

7.9 CHECKING AND CHANGING THE LUBRICATING OIL

After putting the compressor into service the lubricating oil must be changed after the first 50 working hours. The lubricating oil must be changed every 1000 hours working hours or annually.

IMPORTANT: The compressor must be placed on a solid surface with a tilt of no more than 5°.

DANGER: Do not carry out these tasks if the compressor has only just shut down; wait for the compressor to cool. Any oil spilt during the oil change could cause personnel to slip; wear protective garments and anti-slip footwear and remove any traces of oil immediately. Both oil is classified as special wastes and must therefore be disposed of in compliance with the anti-pollution laws in force. All maintenance work must be carried out with the compressor OFF and the power supply lead unplugged from the mains socket.

WARNING: Use only OIL ST755. If it is impossible to find OIL ST755 it is advisable to use a specific oil for breathable air compressors that complies with the characteristics of the table below.

7.9 检查和更换润滑油

压缩机投入使用后，必须在前50个工作小时后更换润滑油。

润滑油必须每1000小时或每年更换一次。

重要事项: 压缩机必须放置在固体表面上，倾斜角度不得超过5°。

危险: 如果压缩机刚刚关闭，请勿执行这些任务；等待压缩机冷却。

换油过程中溢出的任何油都可能导致人员滑倒；穿上防护服和防滑鞋，并立即清除任何油迹。

这两种油都被列为特殊废物，因此必须按照现行的反污染法进行处理。

所有维护工作必须在压缩机关闭且电源线从电源插座拔下的情况下进行。

警告: 仅使用机油ST755。

如果无法找到OIL ST755，建议使用符合下表特征的可呼吸空气压缩机专用机油。

Oil table - 润滑油选择表	
Sump capacity (litres) 容量(升)	1,8
Recommended oils 推荐用油	OIL ST 755
	RECOMMENDED OIL (推荐用油)
Parameter (参数)	Requirement (要求)
Viscosity Grade (粘度等级)	ISO 150
Base Oil (类别)	Synthetic (合成)
Base type (类型)	Ester (酯)
Performance level (性能等级)	DIN 51506-VLD
Primary applications (主要应用)	Lubricant suitable for: Breathing air (ISO EN 12021), Nitrox, Oxygen enriched air up to max 40% O2
Foaming (ASTM D892)	0/0 (all three sequences)
Flash Point (ASTM D92) (闪点)	250°C
Pour Point (ASTM D97) (凝点)	< -30°C
Additives content (性能)	Antiwear, Antioxidant, Antirust, Antifoam (抗磨、抗氧化、防锈、消泡)

(1L) SC000871
PUMPING GROUP OIL
润滑油



SC000872 (5L)
PUMPING GROUP OIL
润滑油



Checking the oil level

The oil level must be checked every 5 working hours of the compressor. The oil level must be between the minimum and the maximum shown on the oil level indicator (a).

Note that an excessive quantity of oil can cause infiltrations in the cylinders and leave deposits on the valves while too low a level prevents proper lubrication and could cause engine seizure.

If the oil level is not within the minimum and maximum limits top up or drain as described in "Changing the lubricating oil".

Changing the lubricating oil

The lubricating oil must be changed every 1000 working hours or annually. To change the oil proceed as described:

- position a recipient under the drain plug (e) so that the oil flows into the exhausted oil recipient (recipient capacity of at least 2,5 litres required);
- open the air vent (d);
- loosen the top-up plug (c);
- remove the plug (b) and drain all the oil;
- replace the plug (b);
- open the top plug (c);
- fill the oil sump with 1,8 litres of oil from top oil plug (see "Oil table");
- close the air vent (d);
- close the oil top plug (c);
- switch on the compressor and run it depressure area for 30 seconds;
- switch off the compressor and remove the plug from the power socket;
- check the oil level (a); if the oil level is not within the allowed limits top up or drain.

检查油位

压缩机每工作5小时必须检查一次油位。机油油位必须在机油油位指示器 (a) 上显示的最小值和最大值之间。

请注意，过量的机油可能会导致气缸渗透，并在气门上留下沉积物，而油位过低会妨碍正确润滑，并可能导致发动机卡滞。

如果油位不在最低和最高限值内，则按照“更换润滑油”中的说明加注或排放。

更换润滑油

润滑油必须每1000个工作小时或每年更换一次。要更换机油，请按照说明进行：

- 将容器放置在排放口 (e) 下方，使油流入排气容器 (容器容量至少为 2.5升)；
- 打开通风口 (d)；
- 松开加注盖 (c)；
- 拆下螺塞 (b) 并排空所有机油；
- 更换螺塞 (b)；
- 打开顶部加油盖 (c)；
- 从顶部加油口向油底壳加注1.8升油 (见“油表”)；
- 关闭排气口 (d)；
- 关闭加注盖 (c)；
- 启动压缩机，在减压区运行30秒；
- 关闭压缩机并从电源插座上拔下插头；
- 检查油位 (a)；如果油位不在允许范围内，则加注或排放。

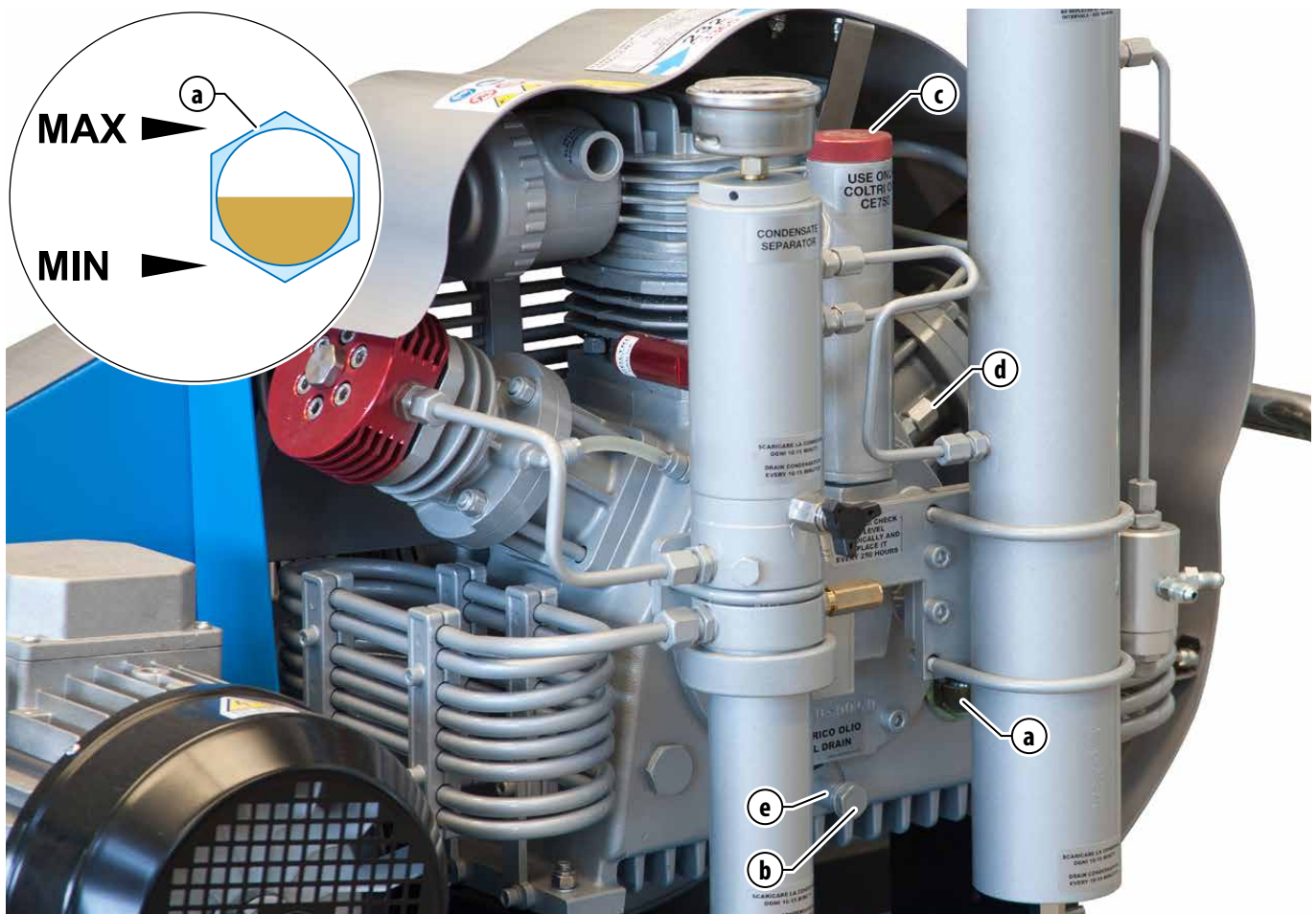

7.10 CHANGING THE FLEX HOSES



IMPORTANT: The hoses must be changed periodically (every 5 years or ever 3000 hours) or when they show signs of abrasion/wear/damage.

The bending radius of the hoses must not be less than 250 mm.



DANGER:

Do not carry out these tasks if the compressor has only just shut down; wait for the compressor to cool.

All maintenance work must be carried out with the compressor OFF and the power supply lead unplugged from the mains socket.

Vent the air from the compressor before carrying out any maintenance tasks.

Tank refill pressure is very high; therefore, before refilling the tanks check that the hoses are perfectly connected and in good condition. Check also that the valves on any unused hoses are closed properly so as to prevent the dangers that derive from hose whiplash.

When the tanks are being refilled unauthorised personnel must remain at a distance of at least 3 metres.

It is strictly forbidden to disconnect the hoses from the fittings or refill valve when the machine is under pressure.

To change the bottle refill hoses proceed as follows:

- disconnect the bottle refill hoses by unscrewing the fittings (14mm wrench).
- replace the old hoses with new ones.
- screw the hoses onto the connectors (a).
- use a dynamometric wrench to tighten the hoses on the compressor with a torque of 15 Nm.

7.10 更换柔性软管



重要提示: 软管必须定期更换（每5年或每3000小时），或当它们出现磨损/磨蚀/损坏的迹象时。

软管的弯曲半径不得小于250毫米



危险:

如果压缩机刚刚关闭，请不要进行这些工作；请等待压缩机冷却。

所有维护工作必须在压缩机关闭和电源线从电源插座上拔下的情况下进行。

在进行任何维护工作之前，请将空气从压缩机中排出。

压力容器加注的压力非常高，因此，在加注容器之前，要检查软管是否连接完好，状况是否良好。还要检查任何未使用的软管上的阀门是否正确关闭，以防止软管鞭打所带来的危险。

当压力容器正在加注时，未经授权的人员必须保持至少3米的距离。

严禁在机器受压时将软管与接头或加注阀断开。

更换瓶子加注软管的步骤如下：

- 拧下接头（14mm扳手），断开瓶子加注软管。
- 用新软管更换旧软管。
- 将软管拧到接头（a）上。
- 使用测力扳手以15 Nm的扭矩拧紧压缩机上的软管。

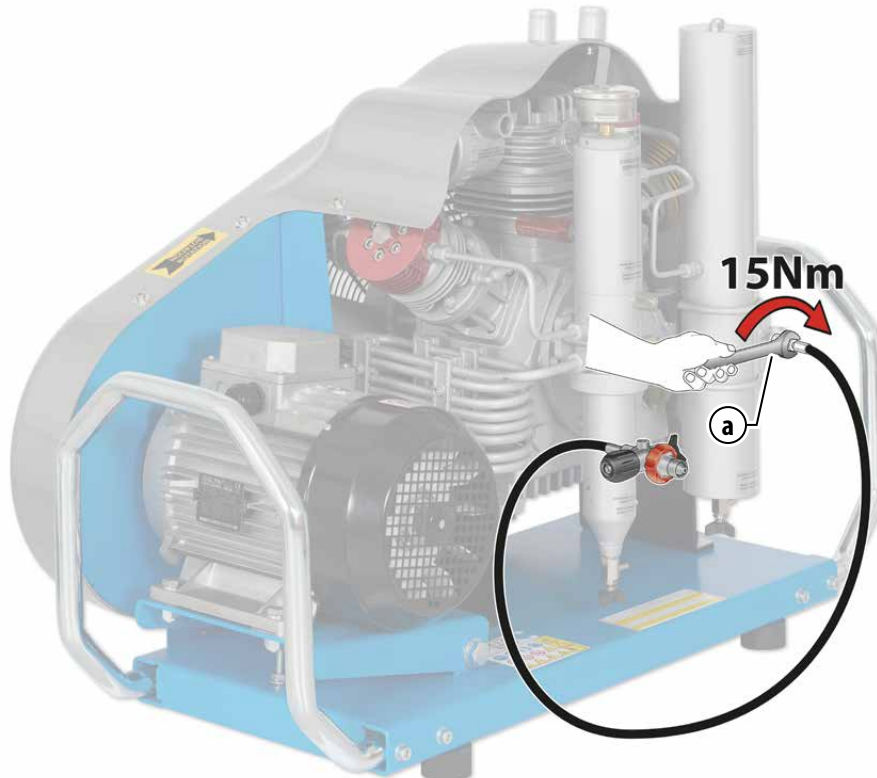

7.11 TRANSMISSION BELT

Belt tension must be checked monthly. The transmission belts must be replaced every 500 working hours of the compressor or annually.



DANGER: Do not carry out these tasks if the compressor has only just shut down; wait for the compressor to cool. All maintenance work must be carried out with the compressor OFF and the power supply lead unplugged from the mains socket.

Checking transmission belt tension

To check the tension on the belt (b) exert a pressure of approximately 10 Kg on the belt; check that the belt does not flex by more than 1 cm with respect to its original position.

Should it flex more than this replace the belt.

Changing transmission belt

To change a belt proceed as follows:

- insert a screwdriver (a) between the belt (b) and the motor pulley (c);
- take the belt out of the pulley groove;
- replace the belt with a new one, making sure that model and length are correct: check that the characteristics of the new belt are identical to the old one;
- insert the belt in the groove of the motor pulley (c);
- insert the belt in the groove of the compressor pulley (d): turn the pulley by hand until the belt slips into the pulley groove perfectly (second diagram);
- check that the belt is inserted perfectly in the grooves of both pulleys and that belt tension is correct.

If the tension of the new belt still fails to comply with the necessary requisites contact assistance service.

7.11 传动皮带

必须每月检查皮带张力。压缩机每工作500小时或每年必须更换一次传动带。



危险: 如果压缩机刚刚关闭, 不要执行这些任务; 等待压缩机冷却。所有维护工作必须在压缩机关闭且电源线从电源插座上拔下的情况下进行。

检查传动带张紧度

为检查皮带的张力 (b), 在皮带上施加约10 Kg的压力; 检查皮带相对于其原始位置的弯曲度是否不超过1 cm。如果它的弯曲度超过这个, 请更换皮带。

更换传动带

更换皮带的步骤如下:

- 在皮带 (b) 和电机皮带轮 (c) 之间插入螺丝刀 (a);
- 将皮带从滑轮槽中取出;
- 更换新皮带, 确保型号和长度正确: 检查新皮带的特性与旧皮带相同;
- 将皮带插入电机皮带轮 (c) 的槽中;
- 将皮带插入压缩机皮带轮槽中 (d): 用手转动皮带轮, 直到皮带完全滑入皮带轮槽中 (第二张图);
- 检查皮带是否完全插入两个皮带轮的凹槽中, 以及皮带张紧度是否正确。

如果新皮带的张力仍然不符合必要条件, 请联系厂家技术服务。

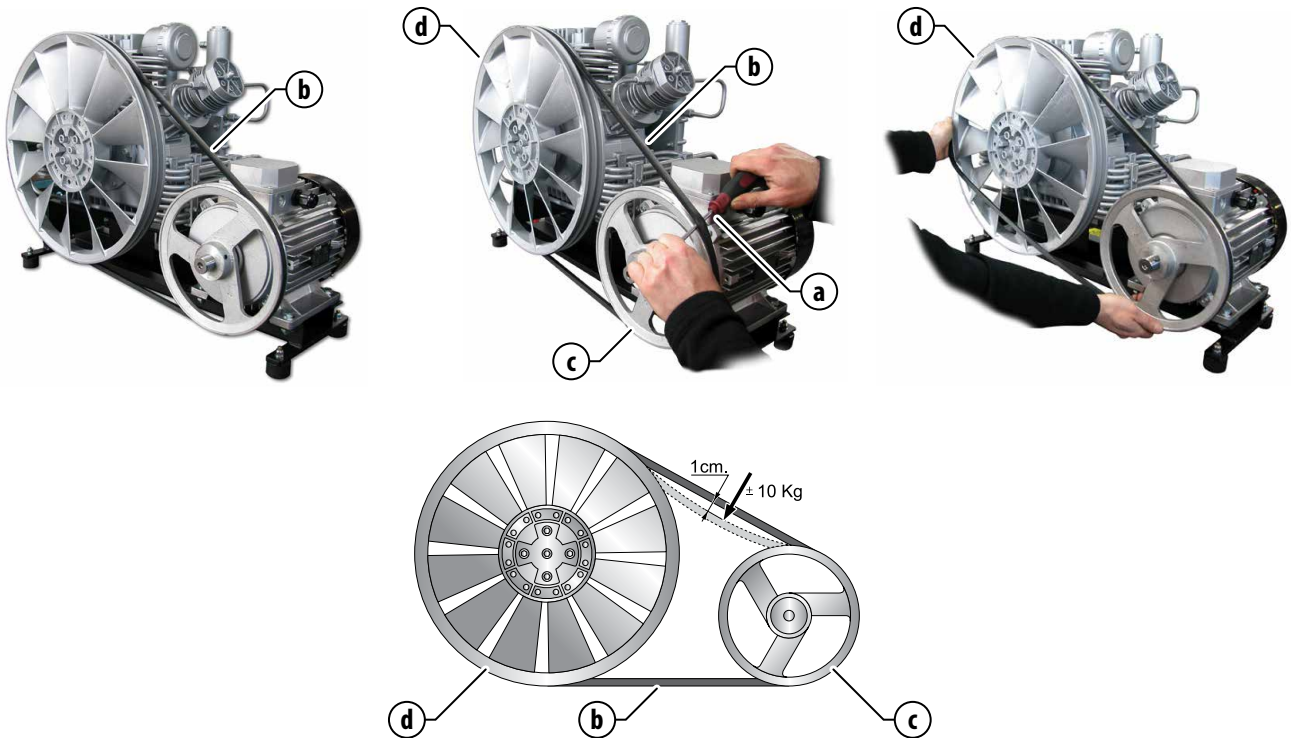

7.12 SAFETY VALVE

7.12 安全阀

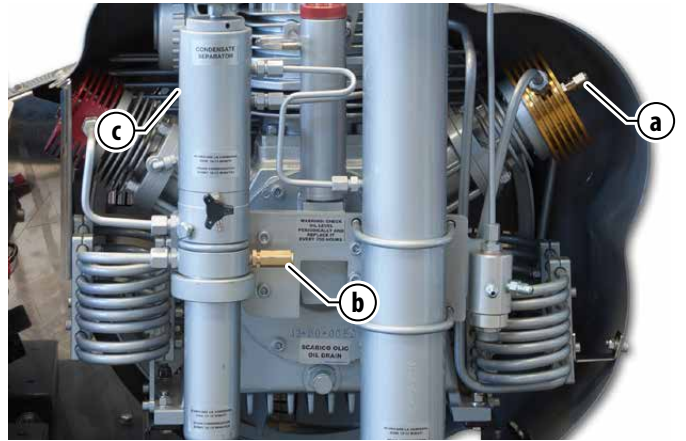
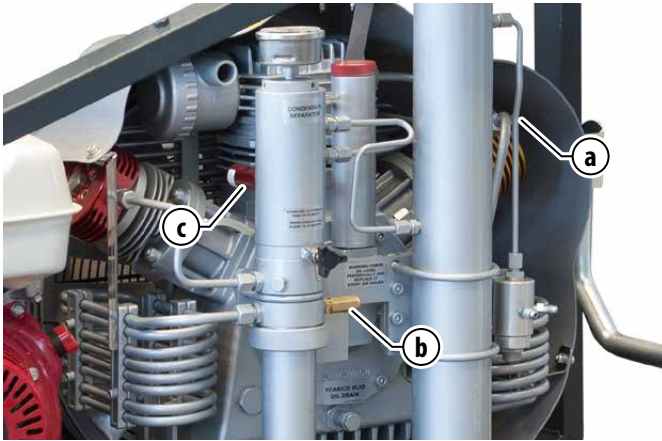

a	b	c
10 bar / 145 psi	70 bar / 1015 psi	232-300-330 bar / 3300-4300-4700 psi



IMPORTANT: The safety valves must be replaced every 10 years or 5000 hours.



重要事项：安全阀（a-b-c）必须每10年或5000小时更换一次。



DANGER:
 Tampering with the safety valve to increase the pressure setting is strictly forbidden.
 Tampering with the safety valve can seriously damage the compressor, cause serious injury to personnel and renders the warranty null and void.



危险：
 严禁篡改安全阀以增加压力设定值。
 篡改安全阀会严重损坏压缩机，对人员造成严重伤害，并使保修失效。

Should the safety valve fail to work properly contact the assistance service.

如果安全阀无法正常工作，请联系厂家援助服务。

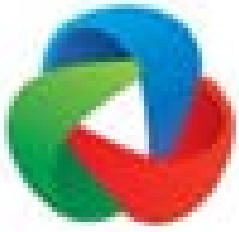

最丰富的产品选择
最安全的产品保障

最经济的市场价格
最完善的售后服务

上海佩恩内贸易有限公司

Shanghai Panny Trading CO.,LTD

地址：上海市浦东新区宁桥路999号15#5，419-424室

电话/Tel: 021-50321602/50321603

E-mail:todd@coltrisub-china.com

<http://www.coltrisub-china.com>