

Protistor® size 2x72 and 2x73 aR

550 to 1250VAC (IEC)

SEMICONDUCTOR PROTECTION FUSES

SQUARE BODY HIGH-SPEED FUSE-LINKS AC PROTECTION



The 1250V Protistor® fuse-links provide maximum flexibility in equipment design and ultimate protection for today's power conversion equipment. These aR ultra-fast acting square body fuse-links are available in different body sizes, each size having multiple worldwide acceptable mounting styles.

They have been engineered to provide state-of-the-art protection for semiconductors: diodes, thyristors and IGBT devices. They are assembled with die-cut elements embedded in solidified sand, which helps control arcing characteristics for a lower I^2t and high interrupting rating level. All contact surfaces are silver plated and all hardware is non-magnetic.

All fuse-links can be equipped with a low voltage trip-indicator which can operate a field mountable microswitch.

TECHNICAL DATA OVERVIEW

Voltage Range AC	550 ... 1250 VAC
Ampere Range (A)	630 ... 3600 A
Speed/Characteristic	aR
I.R. AC (IEC)	100 kA 120 kA 200 kA
Product Size	2x72 and 2x73

FEATURES & BENEFITS

- Multiple body sizes and terminals or blades combination
- aR Class according to IEC 60269-4 and VDE 636-23
- Very low I^2t for improved semiconductor protection
- Ultra fast acting
- Current limiting
- Superior cycling capability

APPLICATIONS

- Protection of inverters, motor drives, UPS systems and similar 690V or less equipments.

STANDARDS

- IEC 60269-4 Compliance
- UL/CSA Recognized E76491 (For some items)



Mersen products have been designed by Mersen for a range of specific applications to be operated depending on particular specification and conditions. Mersen makes no representation or/and warranty, and waives any liability, either express or implied for products' reliability and life time or technical performance in case Mersen has not been provided with customer's specifications or if the products are not purchased directly from Mersen or its distributors and/or agents.

Protistor® size 2x72 and 2x73 aR

550 to 1250VAC (IEC)

PRODUCT RANGE



PC272UD65V25CTF

Size 2x72 type TTF M10 or M12 threaded terminals with omega bar

Catalog number	Item number	Rated voltage AC (IEC)	Rated current I _n	Pre-arcing I ² t	Clearing I ² t at Rated Voltage	Rated breaking capacity AC	Power dissipation at I _n	UL certified	Package	Weight
PC272UD13C630TF	W300721	1250 V	630 A	60 kA ² s	490 kA ² s	100 kA	160 W	x	1	1.70 kg
PC272UD13C700TF	X300722	1250 V	700 A	84 kA ² s	675 kA ² s	100 kA	162 W	x	1	1.70 kg
PC272UD13C800TF	Y300723	1250 V	800 A	130 kA ² s	1065 kA ² s	100 kA	168 W	x	1	1.70 kg
PC272UD13C900TF	Z300724	1250 V	900 A	176 kA ² s	1430 kA ² s	100 kA	183 W	x	1	1.70 kg
PC272UD13C10CTF	A300725	1250 V	1000 A	228 kA ² s	1850 kA ² s	100 kA	197 W	x	1	1.70 kg
PC272UD13C11CTF	B300726	1250 V	1100 A	272 kA ² s	2185 kA ² s	100 kA	231 W	x	1	1.70 kg
PC272UD11C13CTF	M302231	1100 V	1250 A	426 kA ² s	2950 kA ² s	100 kA	237 W	x	1	1.70 kg
PC272UD11C14CTF	D300728	1100 V	1400 A	568 kA ² s	3650 kA ² s	100 kA	256 W	x	1	1.83 kg
PC272UD10C16CTF	L302230	1000 V	1600 A	860 kA ² s	4895 kA ² s	100 kA	262 W	x	1	1.83 kg
PC272UD90V18CTF	F301994	900 V	1800 A	1250 kA ² s	6350 kA ² s	100 kA	275 W	-	1	1.83 kg
PC272UD75V20CTF	E301995	750 V	2000 A	1760 kA ² s	7570 kA ² s	100 kA	285 W	-	1	1.83 kg
PC272UD65V22CTF	G301996	650 V	2200 A	2410 kA ² s	8350 kA ² s	100 kA	320 W	-	1	1.83 kg
PC272UD65V25CTF	H301997	650 V	2500 A	3470 kA ² s	12000 kA ² s	100 kA	340 W	-	1	1.83 kg



PC273UD95V22CTF

Size 2x73 type TTF M10 or M12 threaded terminals with omega bar

Catalog number	Item number	Rated voltage AC (IEC)	Rated current I _n	Pre-arcing I ² t	Clearing I ² t at Rated Voltage	Rated breaking capacity AC	Power dissipation at I _n	UL certified	Package	Weight
PC273UD13C800TF	F300730	1250 V	800 A	100 kA ² s	815 kA ² s	100 kA	195 W	-	1	2.53 kg
PC273UD13C900TF	G300731	1250 V	900 A	142 kA ² s	1150 kA ² s	100 kA	208 W	-	1	2.53 kg
PC273UD13C10CTF	H300732	1250 V	1000 A	176 kA ² s	1400 kA ² s	100 kA	231 W	-	1	2.53 kg
PC273UD13C11CTF	J300733	1250 V	1100 A	228 kA ² s	1860 kA ² s	100 kA	244 W	-	1	2.53 kg
PC273UD13C13CTF	K300734	1250 V	1250 A	336 kA ² s	2660 kA ² s	100 kA	262 W	-	1	2.53 kg
PC273UD11C14CTF	K302229	1100 V	1400 A	454 kA ² s	3060 kA ² s	100 kA	283 W	-	1	2.53 kg
PC273UD11C16CTF	J302228	1100 V	1600 A	760 kA ² s	5210 kA ² s	100 kA	286 W	x	1	2.53 kg
PC273UD11C18CTF	S302236	1100 V	1800 A	1000 kA ² s	6300 kA ² s	100 kA	315 W	-	1	2.53 kg
PC273UD10C20CTF	P300738	1000 V	2000 A	1480 kA ² s	8500 kA ² s	120 kA	319 W	-	1	2.53 kg
PC273UD95V22CTF	Q300739	950 V	2200 A	1780 kA ² s	9632 kA ² s	100 kA	353 W	x	1	2.53 kg

Protistor® size 2x72 and 2x73 aR

550 to 1250VAC (IEC)

PRODUCT RANGE



PC76UD60V32CP11

Size 2x73 type PLAF M10 threaded plates

Catalog number	Item number	Rated voltage AC (IEC)	Rated current I _n	Pre-arcing I ² t	Clearing I ² t at Rated Voltage	Rated breaking capacity AC	Power dissipation at I _n	UL certified	Package	Weight
PC76UD95V22CP11	M301909	950 V	2200 A	1780 kA ² s	9630 kA ² s	100 kA	353 W	x	1	3.1 kg
PC76UD90V25CP11	R300740	900 V	2500 A	2350 kA ² s	12070 kA ² s	110 kA	390 W	x	1	3.1 kg
PC76UD85V28CP11	S300741	850 V	2800 A	3020 kA ² s	15000 kA ² s	100 kA	440 W	x	1	3.1 kg
PC76UD60V30CP11	K301999	600 V	3000 A	4980 kA ² s	15700 kA ² s	200 kA	405 W	-	1	3.1 kg
PC76UD60V32CP11	M302001	600 V	3200 A	5720 kA ² s	19030 kA ² s	200 kA	426 W	x	1	3.1 kg
PC76UD55V36CP11	N302002	550 V	3600 A	8170 kA ² s	25200 kA ² s	200 kA	430 W	-	1	3.1 kg

Mersen products have been designed by Mersen for a range of specific applications to be operated depending on particular specification and conditions. Mersen makes no representation or/and warranty, and waives any liability, either express or implied for products' reliability and life time or technical performance in case Mersen has not been provided with customer's specifications or if the products are not purchased directly from Mersen or its distributors and/or agents.

TIME CURRENT CHARACTERISTIC CURVES

Size 2x72

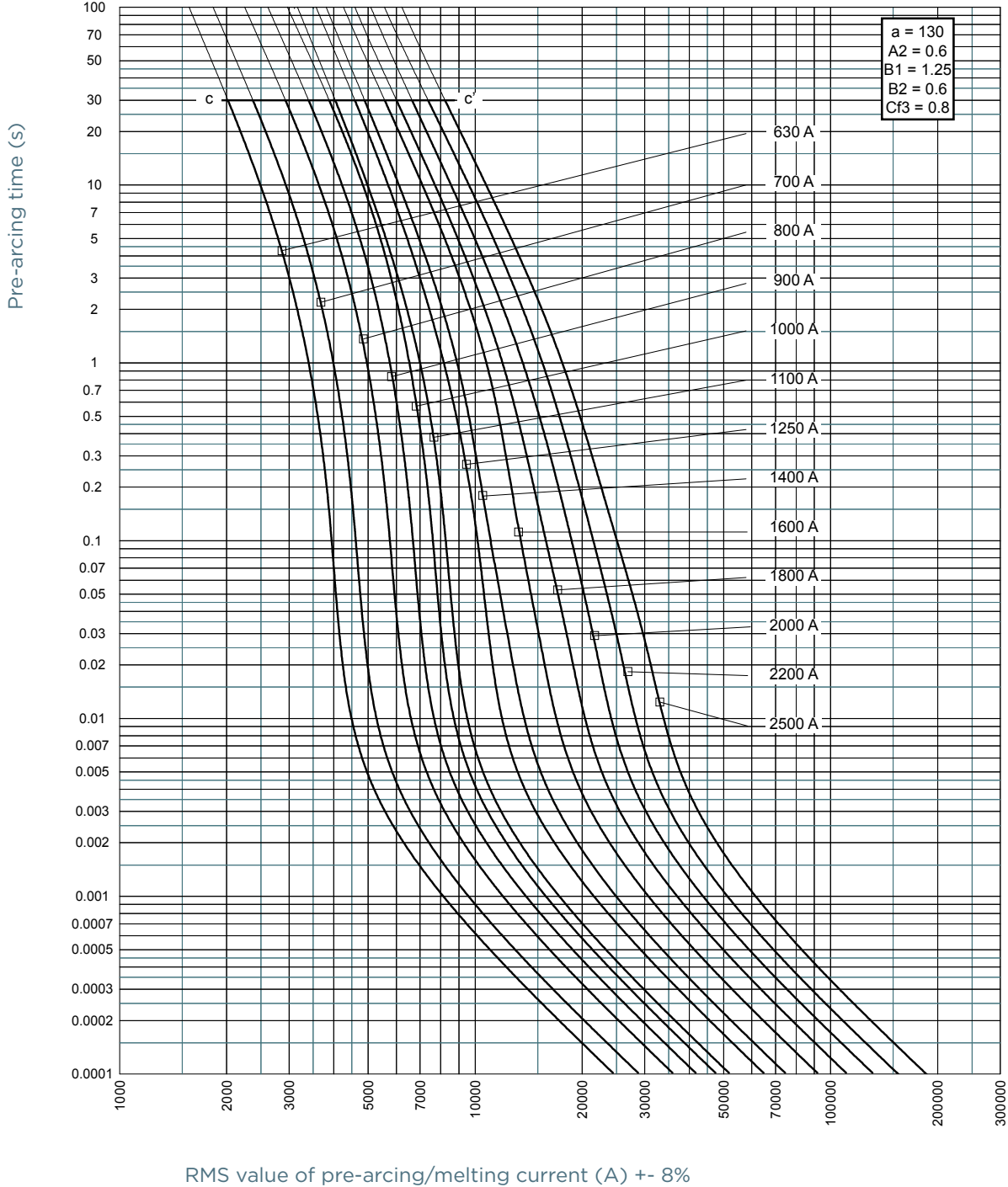

Mersen products have been designed by Mersen for a range of specific applications to be operated depending on particular specification and conditions. Mersen makes no representation or/and warranty, and waives any liability, either express or implied for products' reliability and life time or technical performance in case Mersen has not been provided with customer's specifications or if the products are not purchased directly from Mersen or its distributors and/or agents.

Protistor® size 2x72 and 2x73 aR

550 to 1250VAC (IEC)

TIME CURRENT CHARACTERISTIC CURVES

Size 2x73

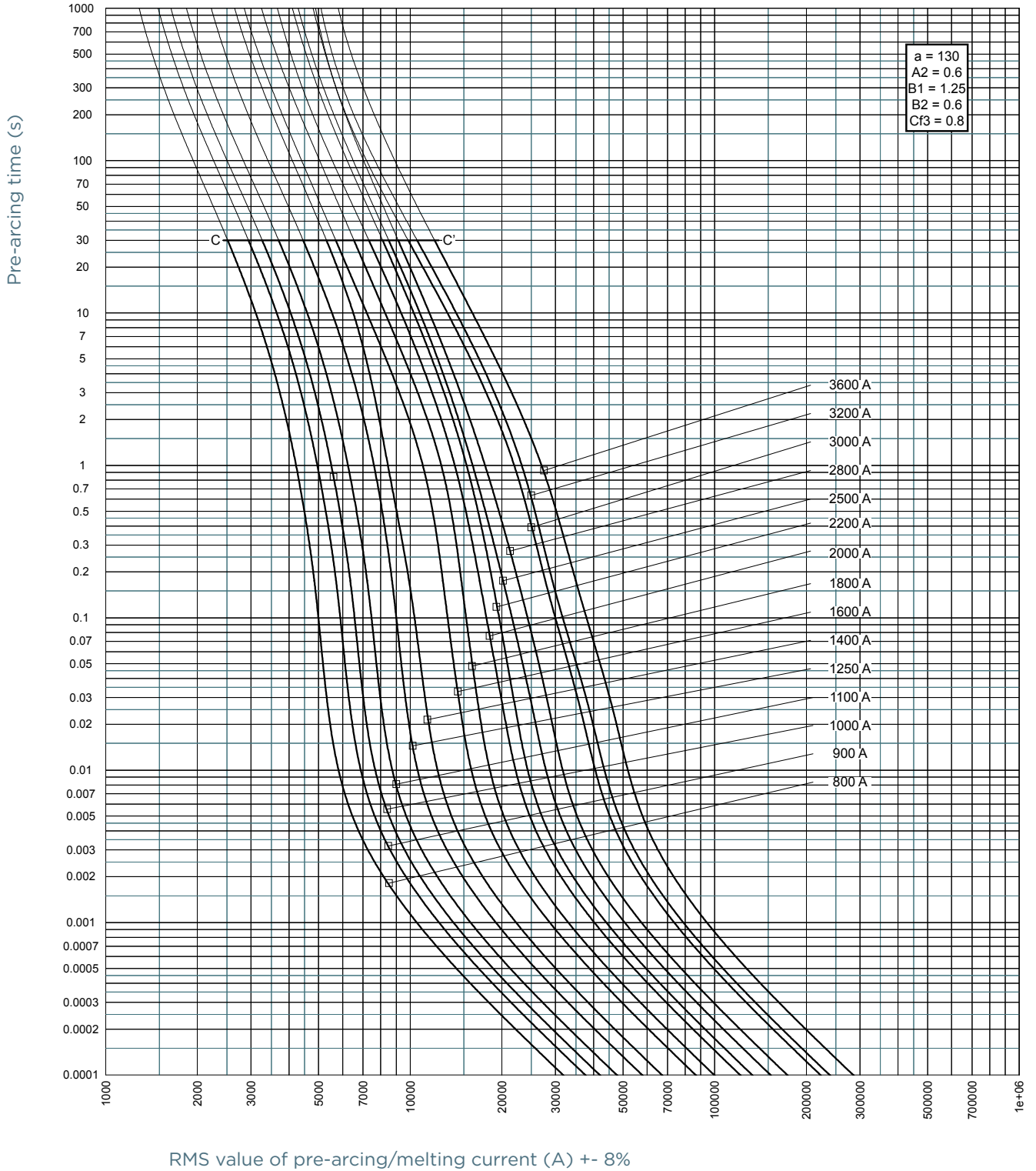

Mersen products have been designed by Mersen for a range of specific applications to be operated depending on particular specification and conditions. Mersen makes no representation or/and warranty, and waives any liability, either express or implied for products' reliability and life time or technical performance in case Mersen has not been provided with customer's specifications or if the products are not purchased directly from Mersen or its distributors and/or agents.

CUT-OFF CURRENT CHARACTERISTIC

Size 2x72

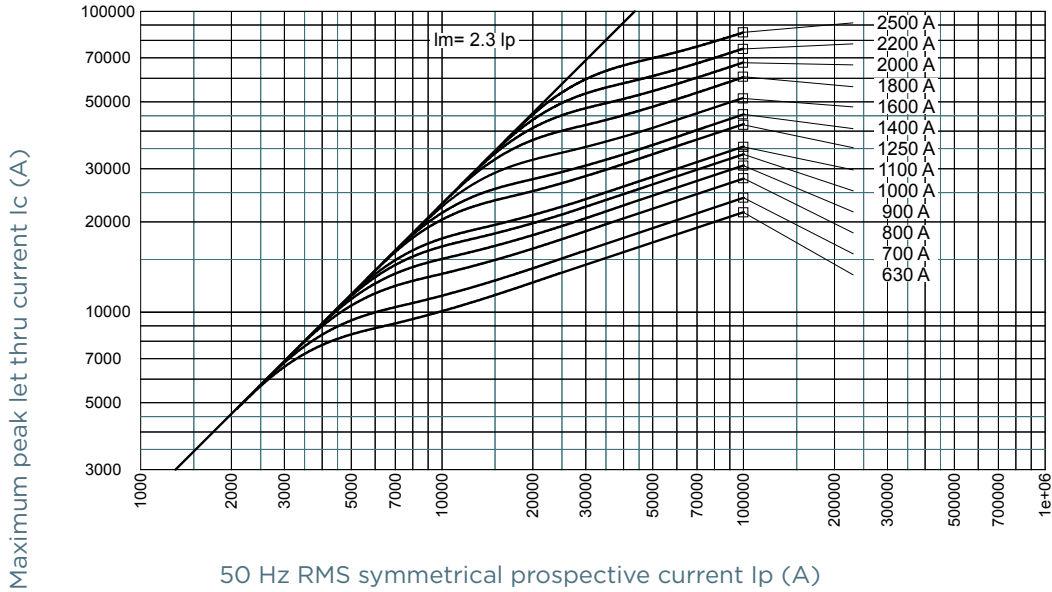

Size 2x73

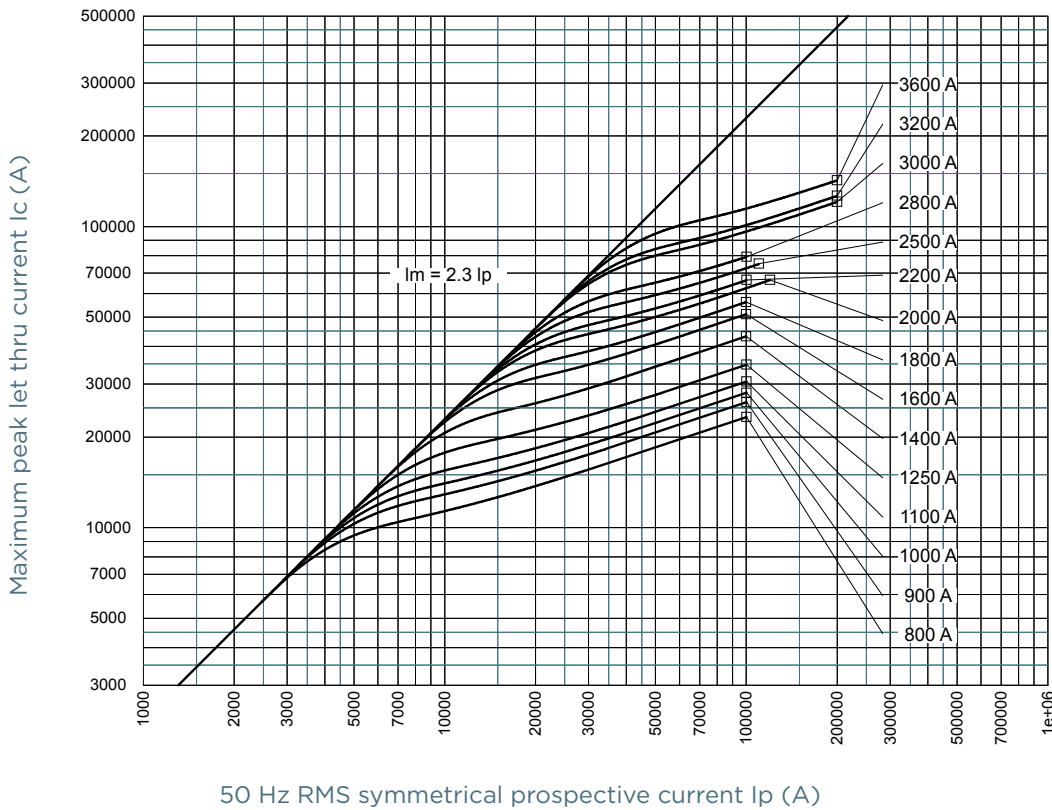

Mersen products have been designed by Mersen for a range of specific applications to be operated depending on particular specification and conditions. Mersen makes no representation or/and warranty, and waives any liability, either express or implied for products' reliability and life time or technical performance in case Mersen has not been provided with customer's specifications or if the products are not purchased directly from Mersen or its distributors and/or agents.

Protistor® size 2x72 and 2x73 aR

550 to 1250VAC (IEC)

I²T MULTIPLIER COEFFICIENT

size 2x72 650V

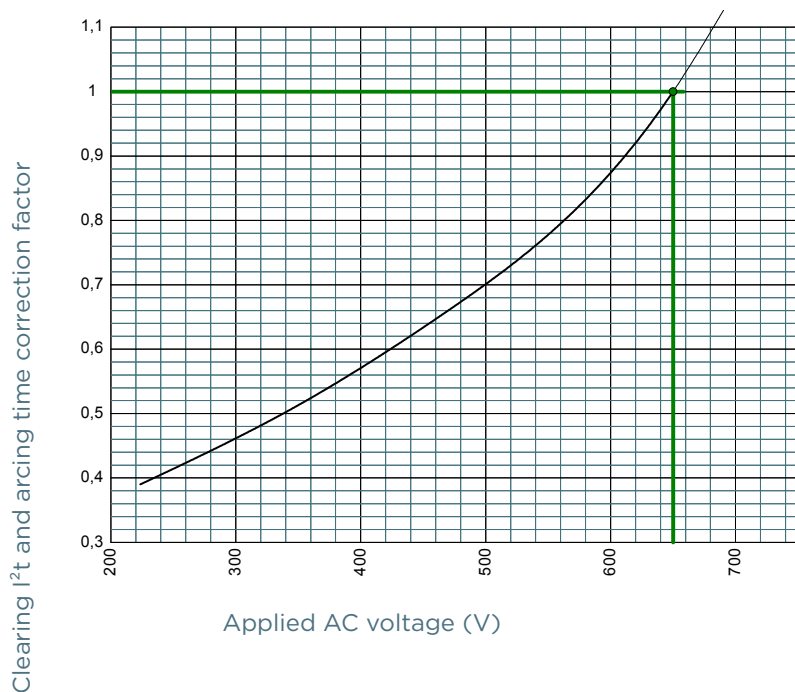

size 2x72 750V

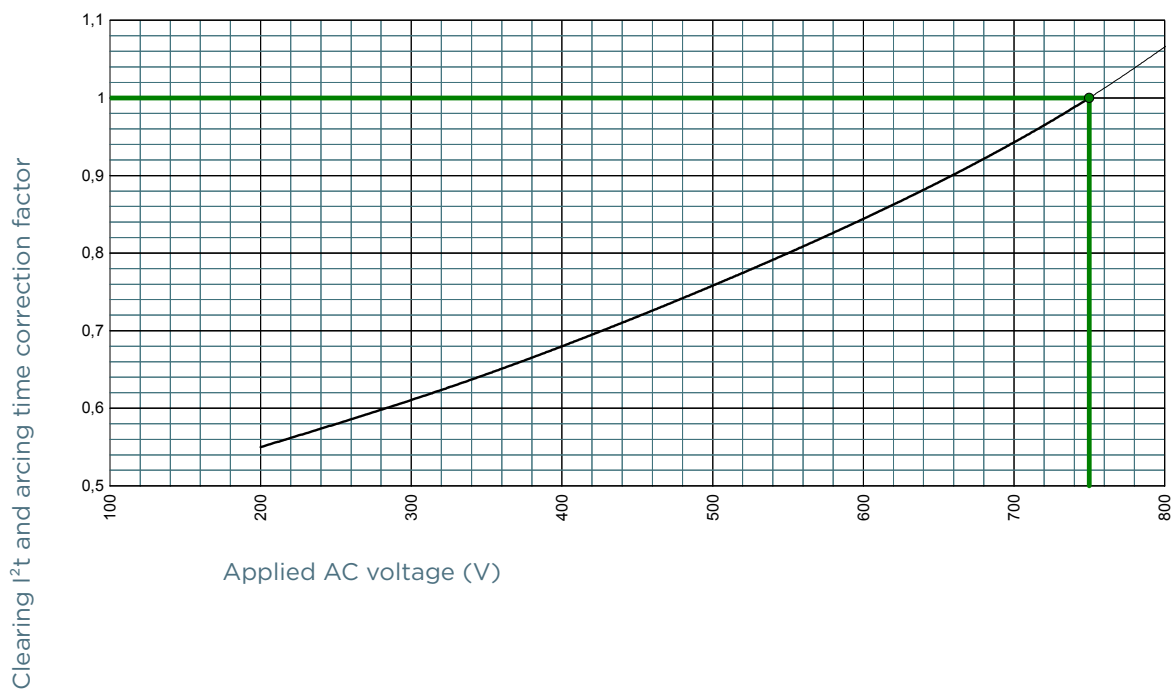

Mersen products have been designed by Mersen for a range of specific applications to be operated depending on particular specification and conditions. Mersen makes no representation or/and warranty, and waives any liability, either express or implied for products' reliability and life time or technical performance in case Mersen has not been provided with customer's specifications or if the products are not purchased directly from Mersen or its distributors and/or agents.

Protistor® size 2x72 and 2x73 aR

550 to 1250VAC (IEC)

I²T MULTIPLIER COEFFICIENT

size 2x72 900V

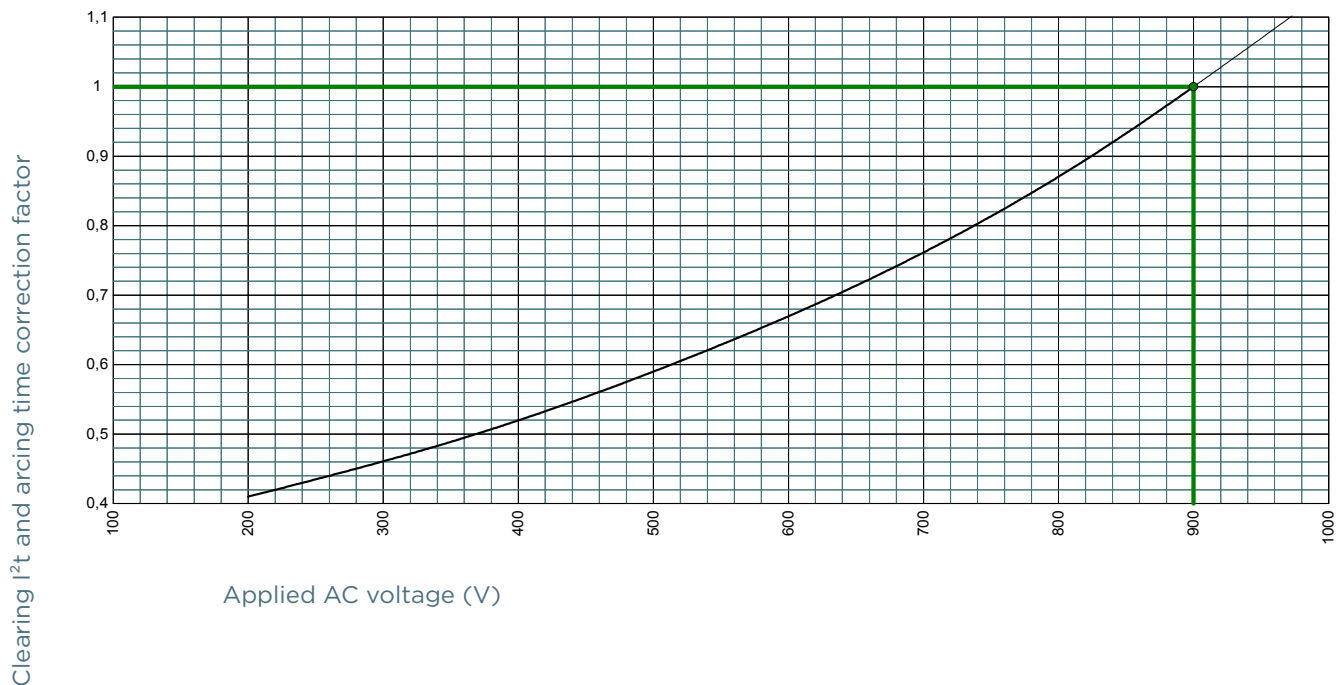

size 2x72 1000V

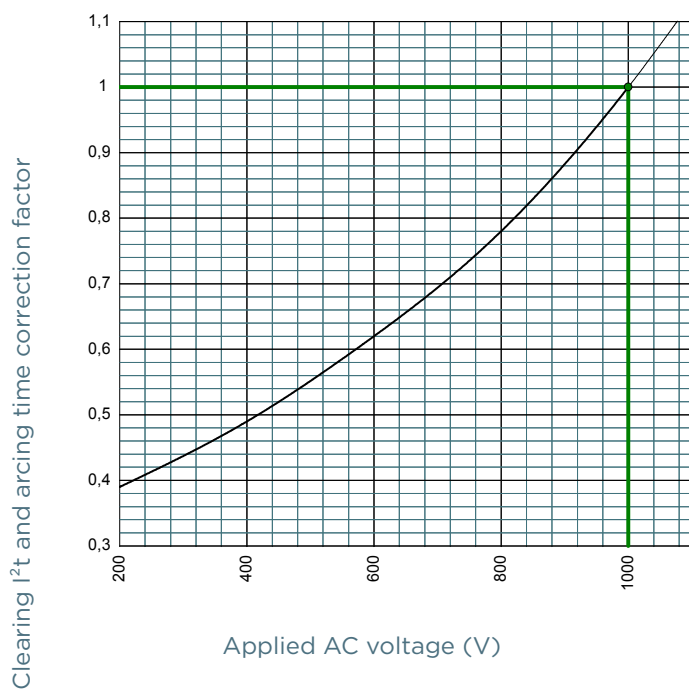

Mersen products have been designed by Mersen for a range of specific applications to be operated depending on particular specification and conditions. Mersen makes no representation or/and warranty, and waives any liability, either express or implied for products' reliability and life time or technical performance in case Mersen has not been provided with customer's specifications or if the products are not purchased directly from Mersen or its distributors and/or agents.

Protistor® size 2x72 and 2x73 aR

550 to 1250VAC (IEC)

I²T MULTIPLIER COEFFICIENT

size 2x72 1100V

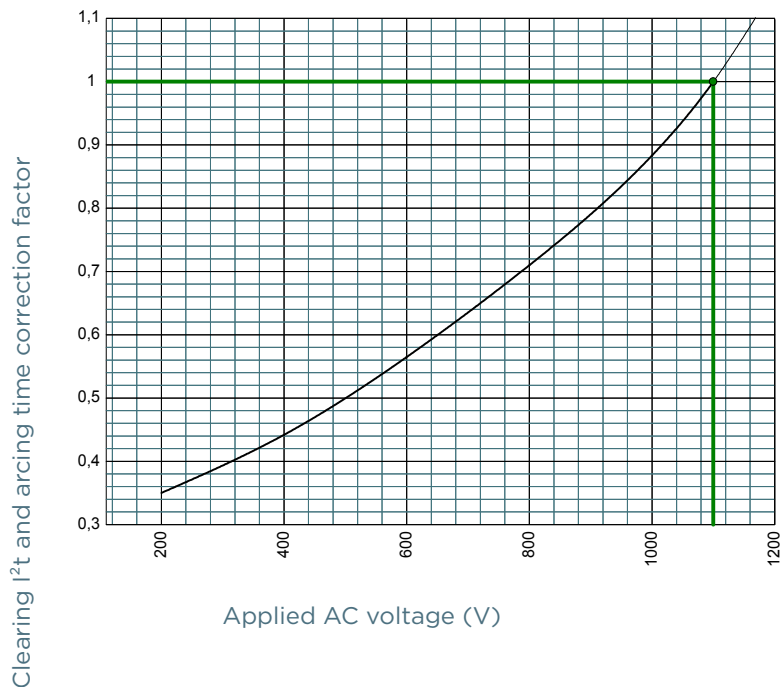

size 2x72 1250V

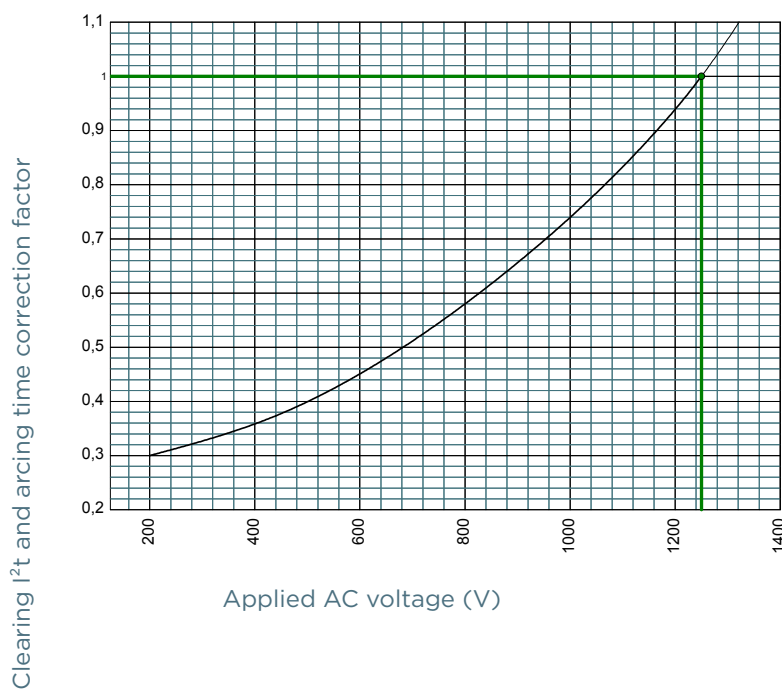

Mersen products have been designed by Mersen for a range of specific applications to be operated depending on particular specification and conditions. Mersen makes no representation or/and warranty, and waives any liability, either express or implied for products' reliability and life time or technical performance in case Mersen has not been provided with customer's specifications or if the products are not purchased directly from Mersen or its distributors and/or agents.

Protistor® size 2x72 and 2x73 aR

550 to 1250VAC (IEC)

I²T MULTIPLIER COEFFICIENT

size 2x73 550V

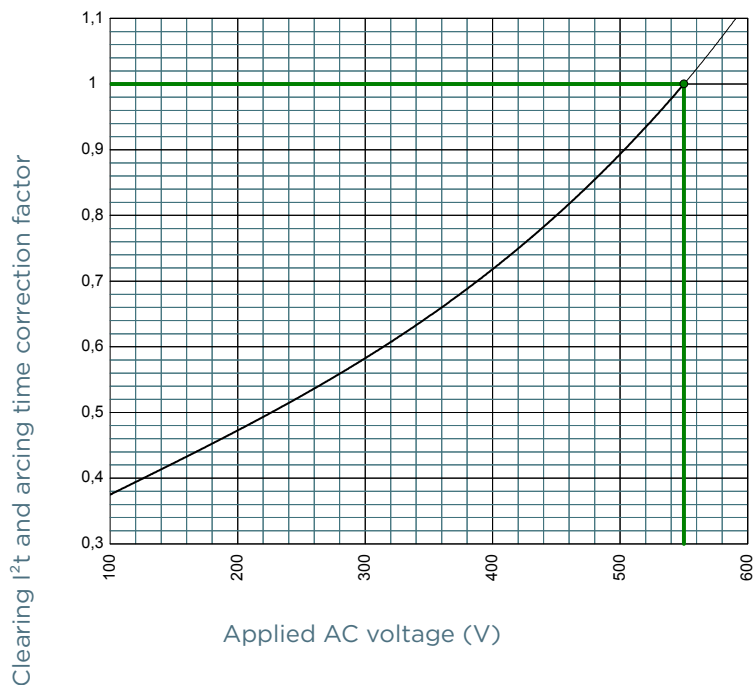

size 2x73 600V

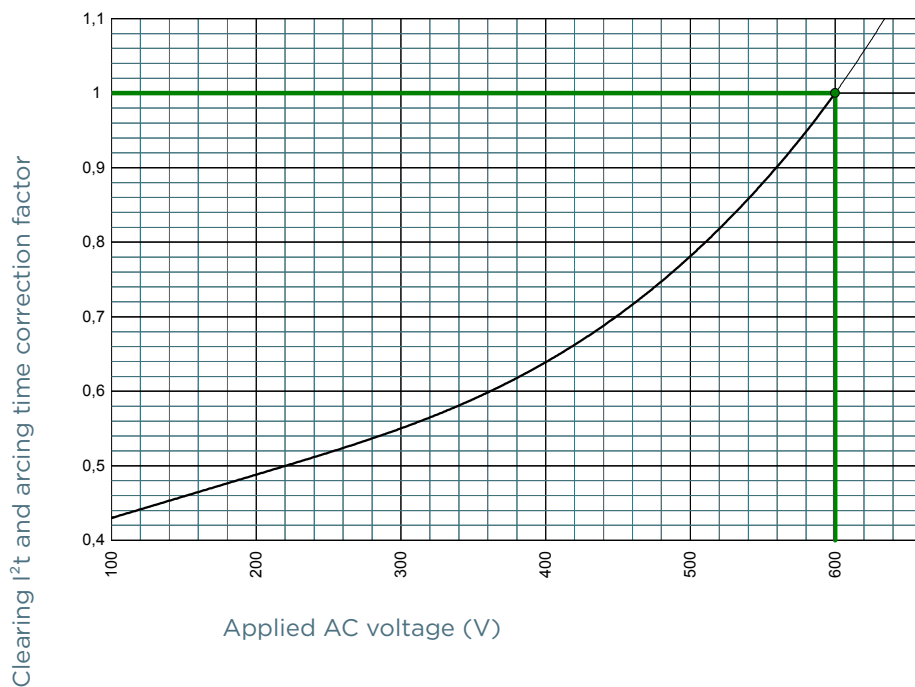

Mersen products have been designed by Mersen for a range of specific applications to be operated depending on particular specification and conditions. Mersen makes no representation or/and warranty, and waives any liability, either express or implied for products' reliability and life time or technical performance in case Mersen has not been provided with customer's specifications or if the products are not purchased directly from Mersen or its distributors and/or agents.

Protistor® size 2x72 and 2x73 aR

550 to 1250VAC (IEC)

I²T MULTIPLIER COEFFICIENT

size 2x73 850V

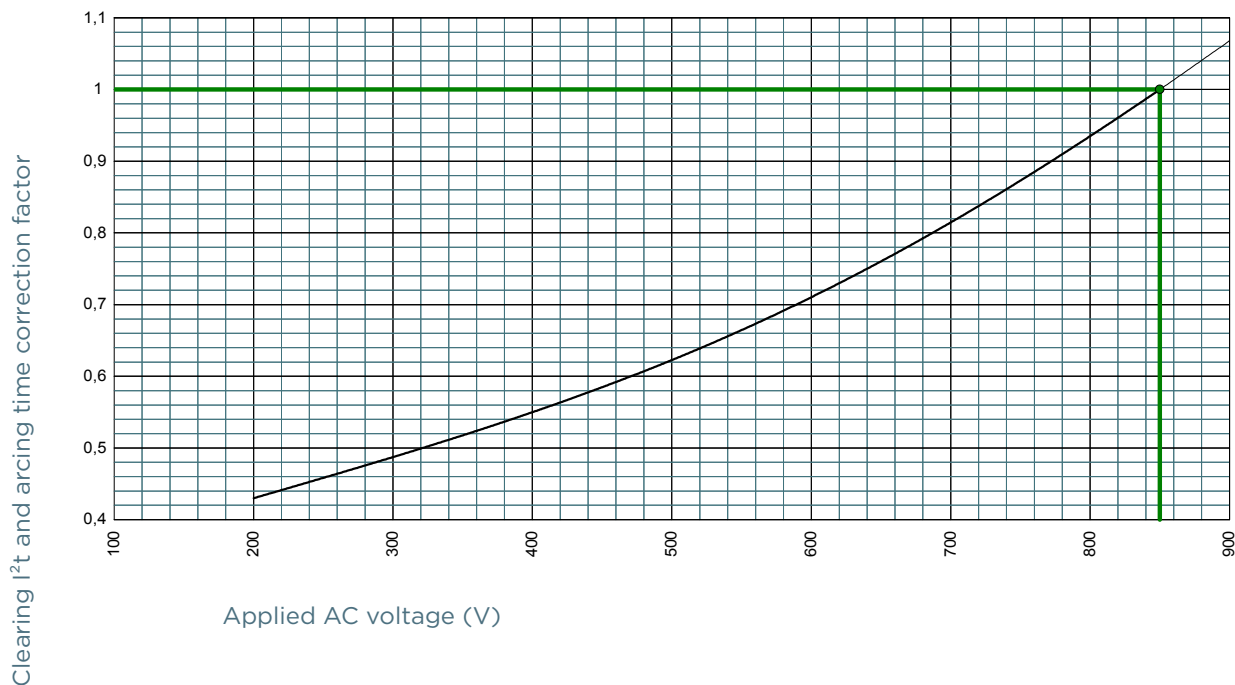

size 2x73 900V

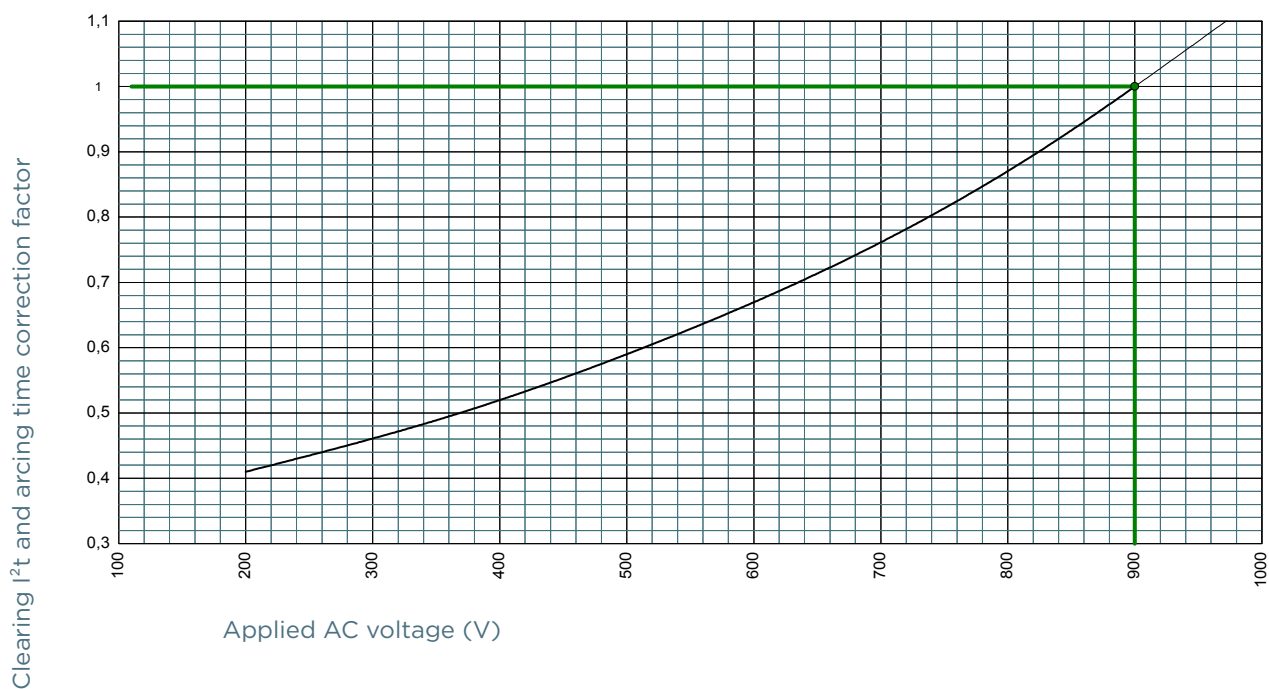

Mersen products have been designed by Mersen for a range of specific applications to be operated depending on particular specification and conditions. Mersen makes no representation or/and warranty, and waives any liability, either express or implied for products' reliability and life time or technical performance in case Mersen has not been provided with customer's specifications or if the products are not purchased directly from Mersen or its distributors and/or agents.

Protistor® size 2x72 and 2x73 aR

550 to 1250VAC (IEC)

I²T MULTIPLIER COEFFICIENT

size 2x73 950V

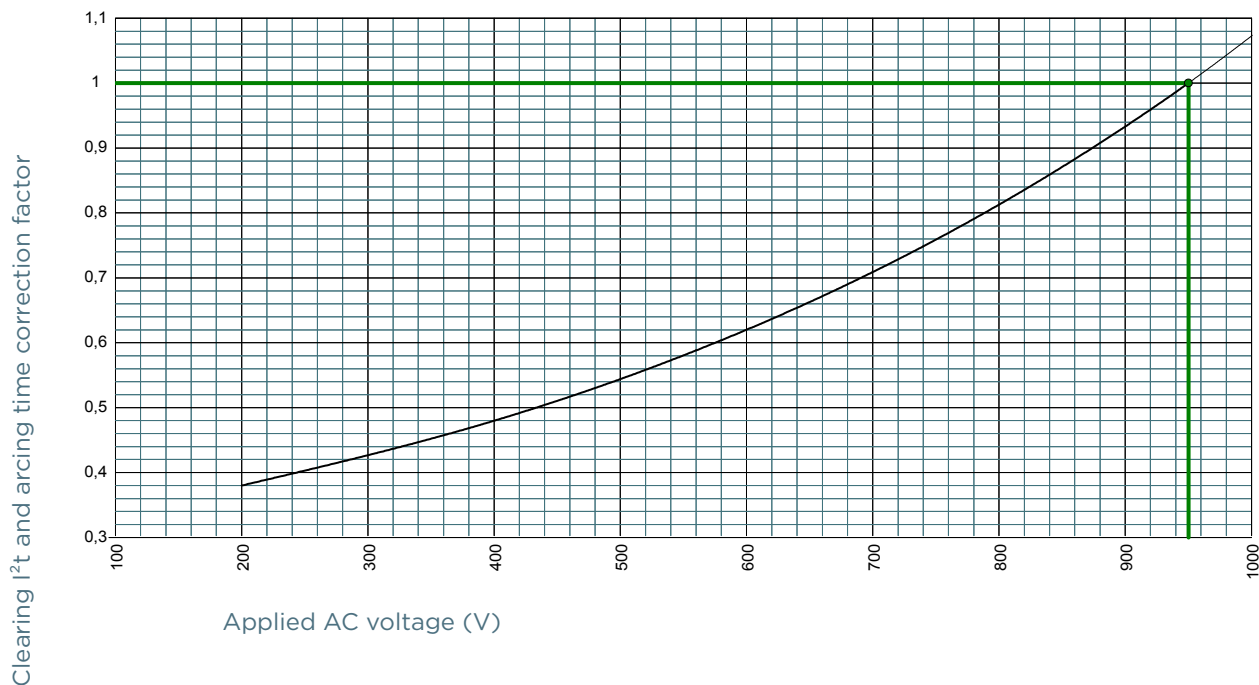

size 2x73 1000V

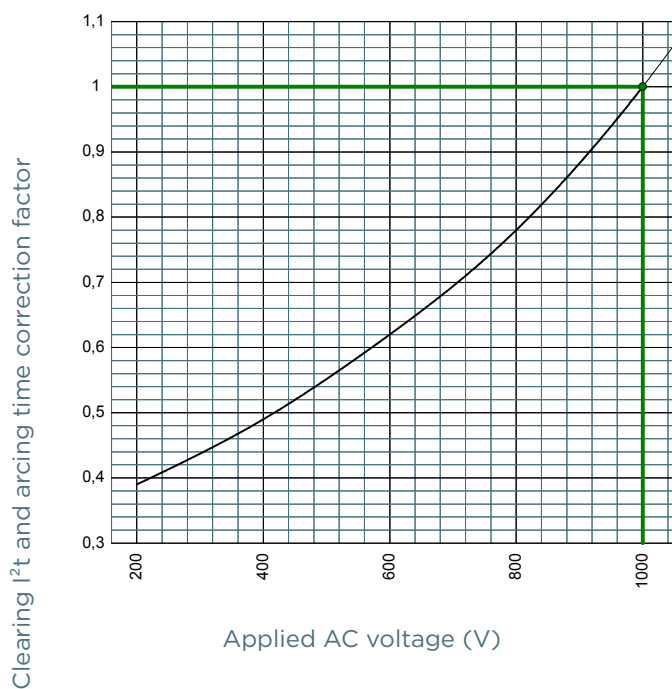

Mersen products have been designed by Mersen for a range of specific applications to be operated depending on particular specification and conditions. Mersen makes no representation or/and warranty, and waives any liability, either express or implied for products' reliability and life time or technical performance in case Mersen has not been provided with customer's specifications or if the products are not purchased directly from Mersen or its distributors and/or agents.

Protistor® size 2x72 and 2x73 aR

550 to 1250VAC (IEC)

I²T MULTIPLIER COEFFICIENT

size 2x73 1100V

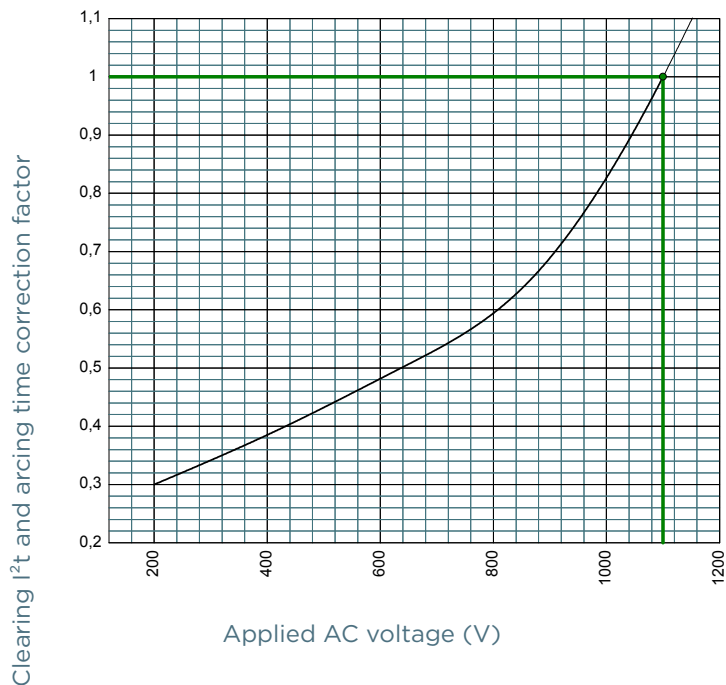

size 2x73 1250V

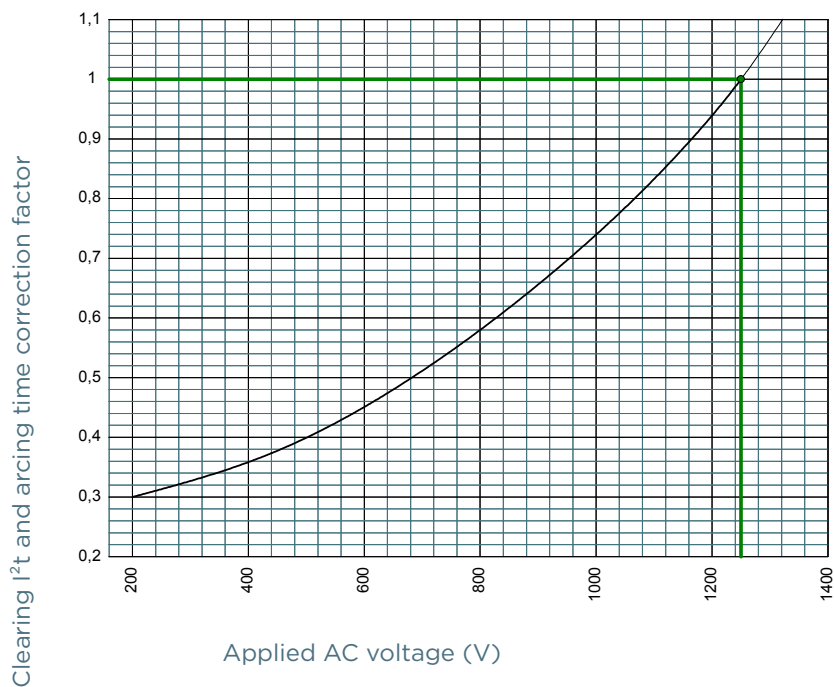

Mersen products have been designed by Mersen for a range of specific applications to be operated depending on particular specification and conditions. Mersen makes no representation or/and warranty, and waives any liability, either express or implied for products' reliability and life time or technical performance in case Mersen has not been provided with customer's specifications or if the products are not purchased directly from Mersen or its distributors and/or agents.

Protistor® size 2x72 and 2x73 aR

550 to 1250VAC (IEC)

CHARACTERISTICS TOTAL I²T CURVE

size 2x072 650V

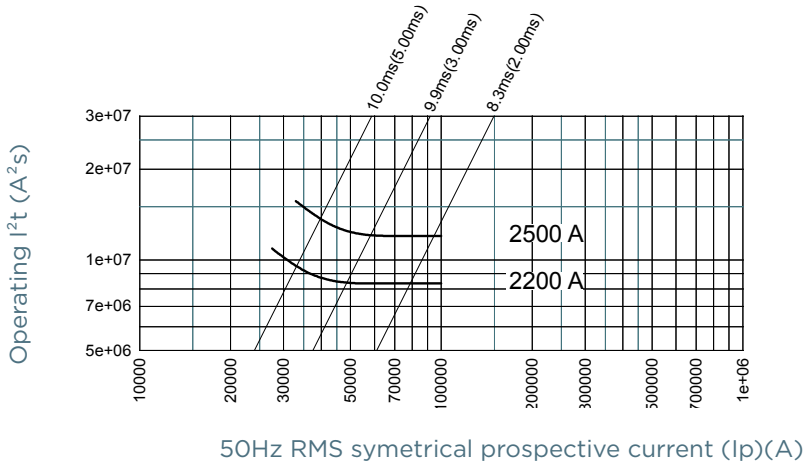

size 2x072 750V

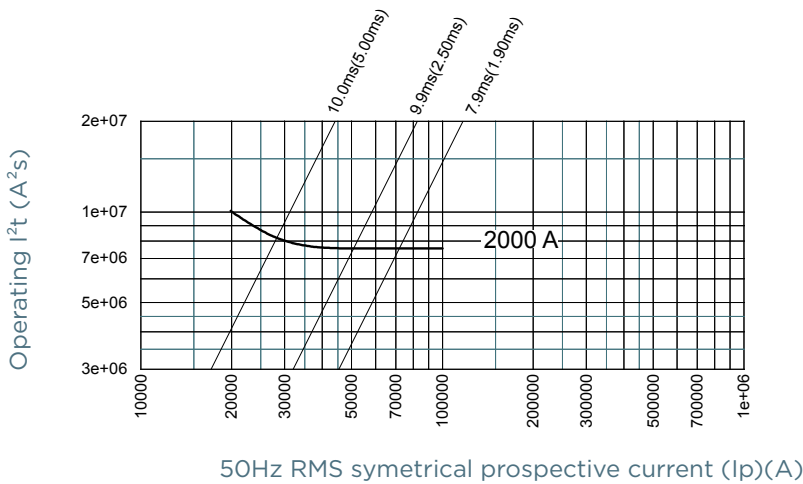

size 2x072 900V

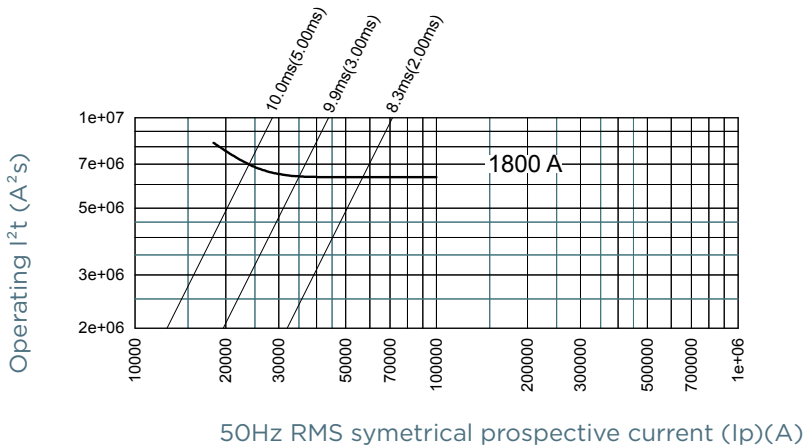

Mersen products have been designed by Mersen for a range of specific applications to be operated depending on particular specification and conditions. Mersen makes no representation or/and warranty, and waives any liability, either express or implied for products' reliability and life time or technical performance in case Mersen has not been provided with customer's specifications or if the products are not purchased directly from Mersen or its distributors and/or agents.

Protistor® size 2x72 and 2x73 aR

550 to 1250VAC (IEC)

CHARACTERISTICS TOTAL I²T CURVE

size 2x072 1000V

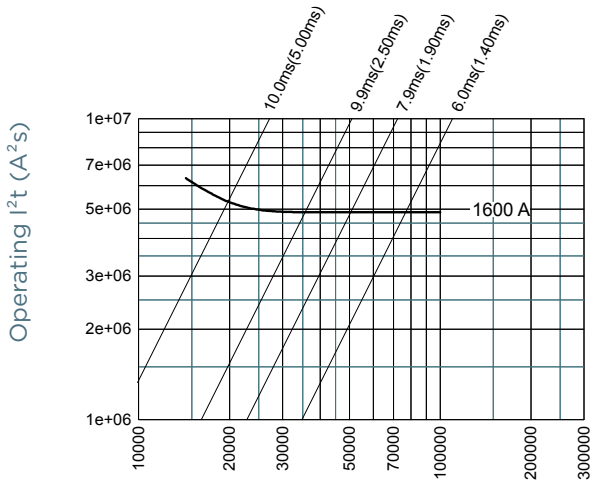

size 2x072 1100V

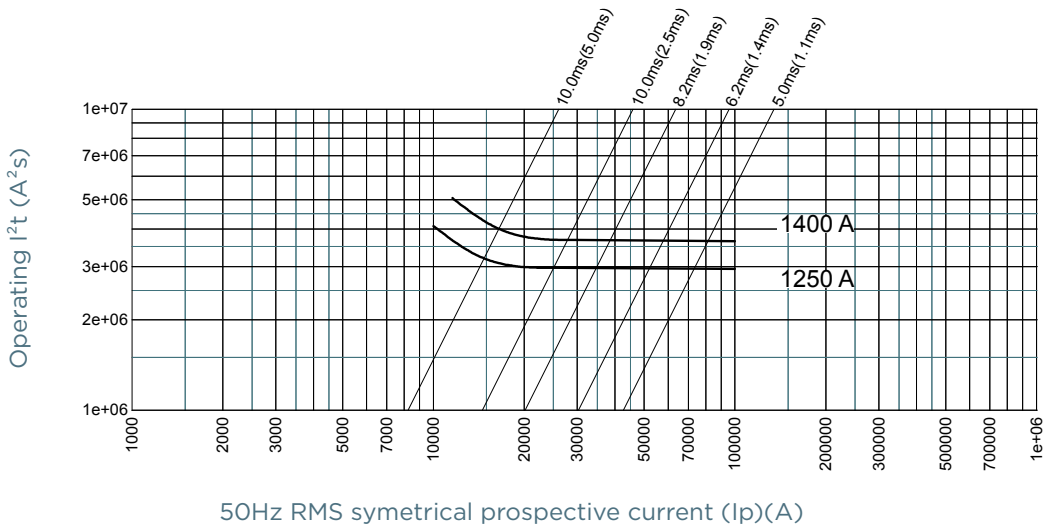

Protistor® size 2x72 and 2x73 aR

550 to 1250VAC (IEC)

CHARACTERISTICS TOTAL I²T CURVE

size 2x072 1250V

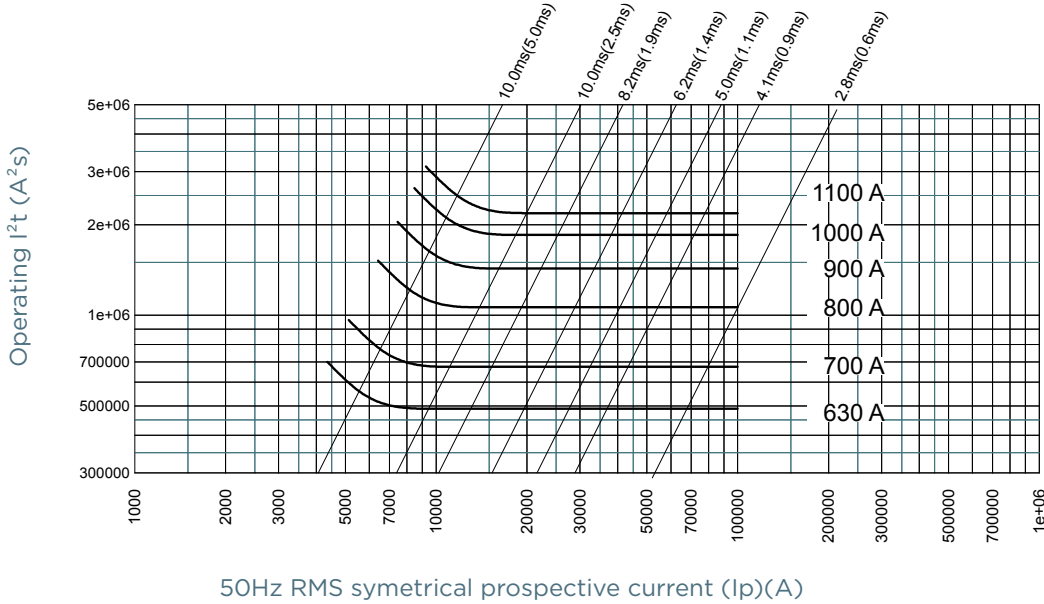

size 2x073 550V

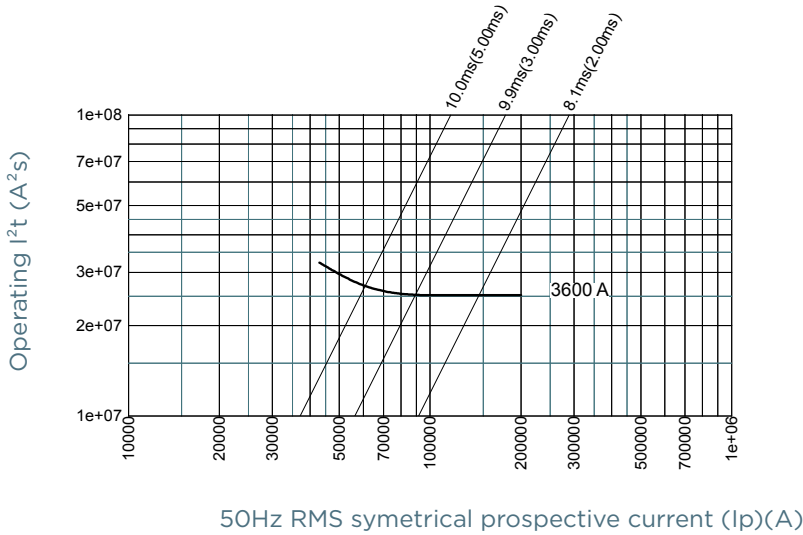

Mersen products have been designed by Mersen for a range of specific applications to be operated depending on particular specification and conditions. Mersen makes no representation or/and warranty, and waives any liability, either express or implied for products' reliability and life time or technical performance in case Mersen has not been provided with customer's specifications or if the products are not purchased directly from Mersen or its distributors and/or agents.

Protistor® size 2x72 and 2x73 aR

550 to 1250VAC (IEC)

CHARACTERISTICS TOTAL I²T CURVE

size 2x073 600V

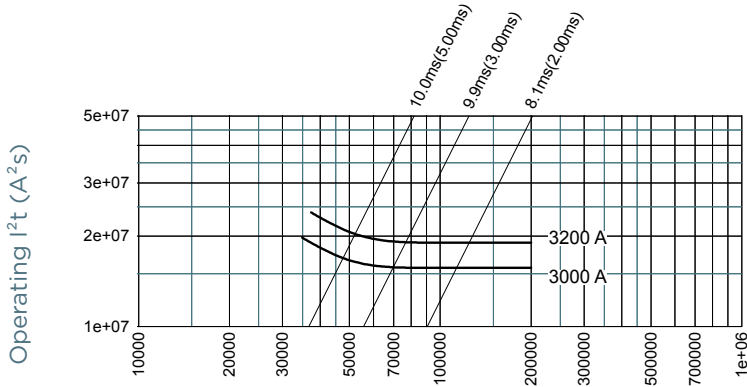

50Hz RMS symmetrical prospective current (Ip)(A)

size 2x073 850V

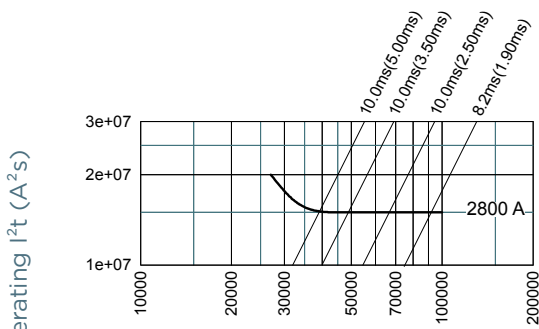

50Hz RMS symmetrical prospective current (Ip)(A)

size 2x073 900V

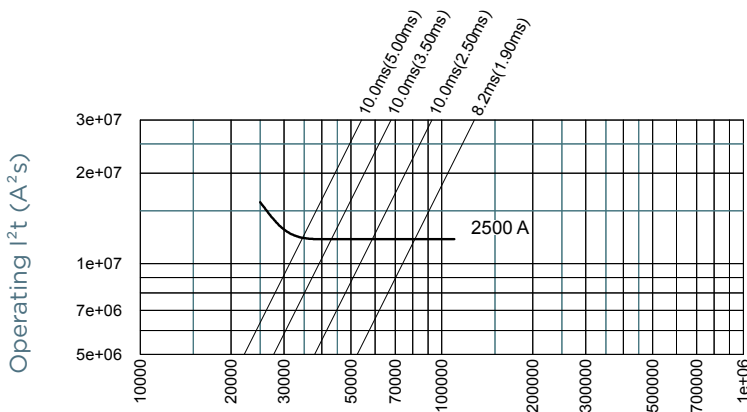

50Hz RMS symmetrical prospective current (Ip)(A)

Mersen products have been designed by Mersen for a range of specific applications to be operated depending on particular specification and conditions. Mersen makes no representation or/and warranty, and waives any liability, either express or implied for products' reliability and life time or technical performance in case Mersen has not been provided with customer's specifications or if the products are not purchased directly from Mersen or its distributors and/or agents.

Protistor® size 2x72 and 2x73 aR

550 to 1250VAC (IEC)

CHARACTERISTICS TOTAL I²T CURVE

size 2x073 950V

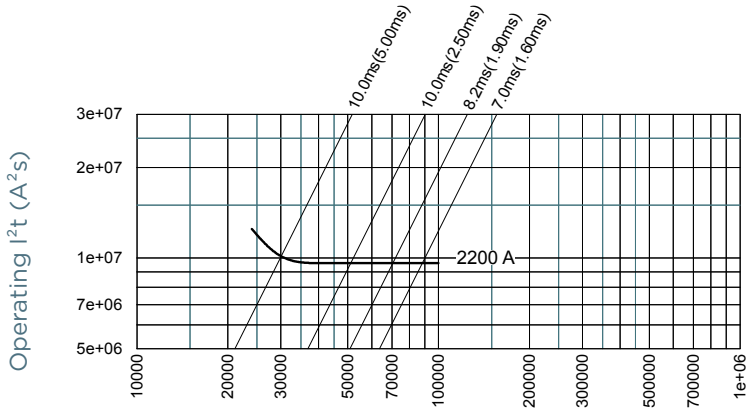

50Hz RMS symmetrical prospective current (Ip)(A)

size 2x073 1000V

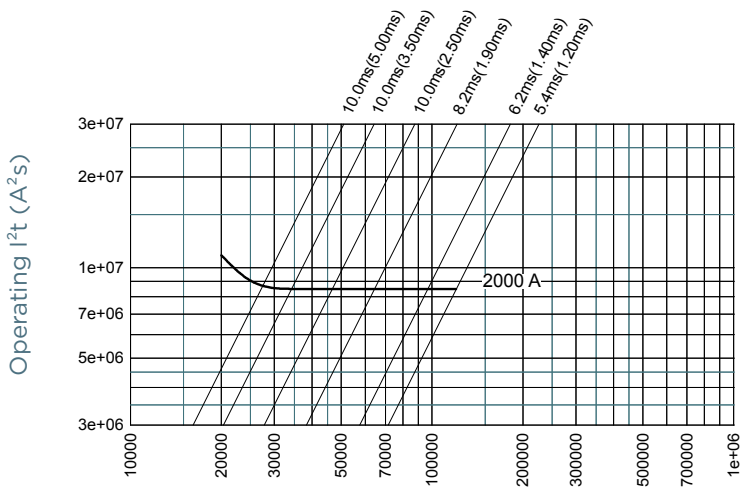

50Hz RMS symmetrical prospective current (Ip)(A)

Mersen products have been designed by Mersen for a range of specific applications to be operated depending on particular specification and conditions. Mersen makes no representation or/and warranty, and waives any liability, either express or implied for products' reliability and life time or technical performance in case Mersen has not been provided with customer's specifications or if the products are not purchased directly from Mersen or its distributors and/or agents.

Protistor® size 2x72 and 2x73 aR

550 to 1250VAC (IEC)

CHARACTERISTICS TOTAL I²T CURVE

size 2x073 1100V

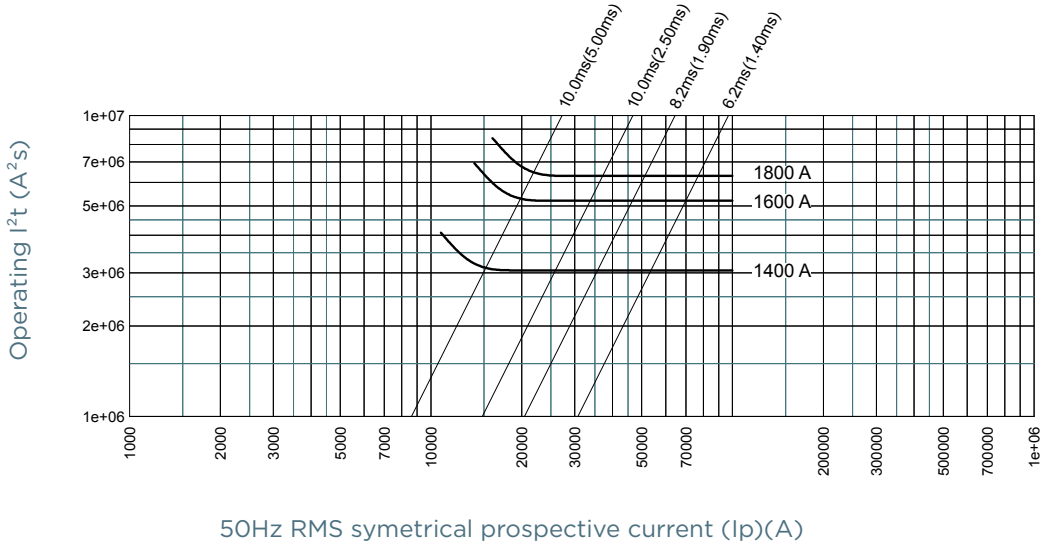

size 2x073 1250V

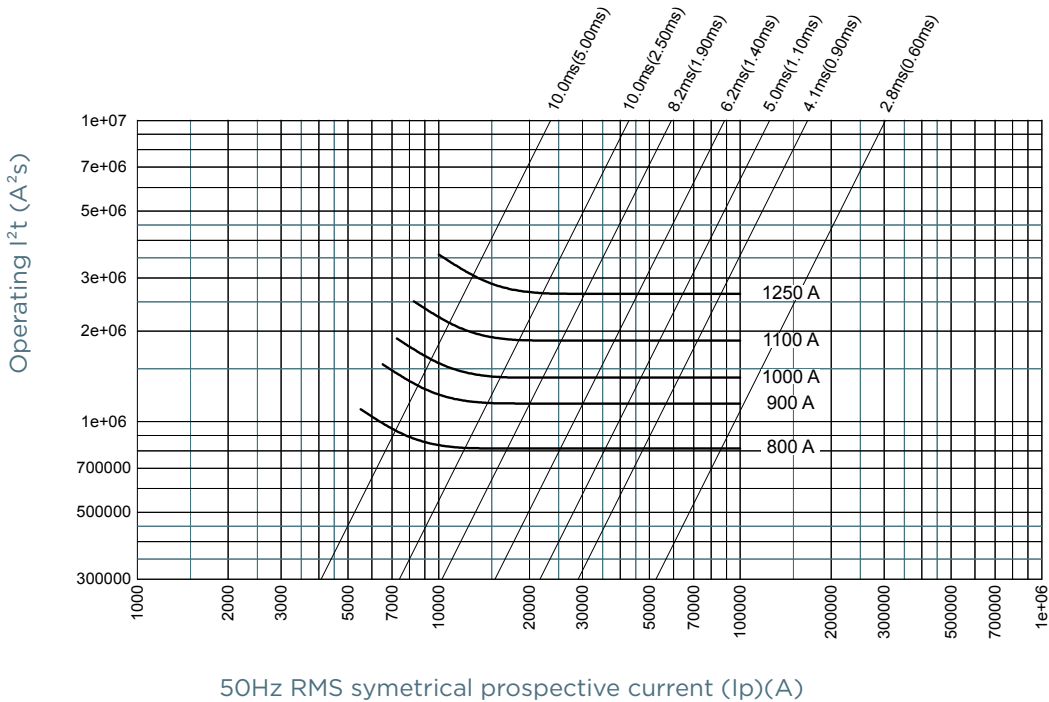

Mersen products have been designed by Mersen for a range of specific applications to be operated depending on particular specification and conditions. Mersen makes no representation or/and warranty, and waives any liability, either express or implied for products' reliability and life time or technical performance in case Mersen has not been provided with customer's specifications or if the products are not purchased directly from Mersen or its distributors and/or agents.

Protistor® size 2x72 and 2x73 aR

550 to 1250VAC (IEC)

POWER DISSIPATION

size 2x72

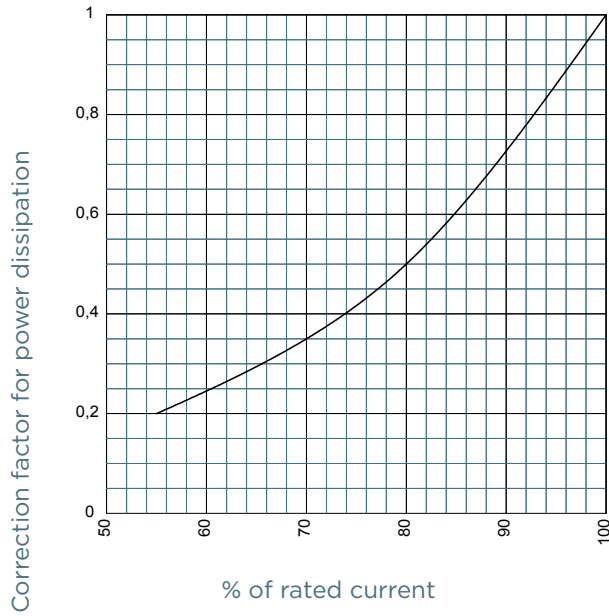

size 2x73

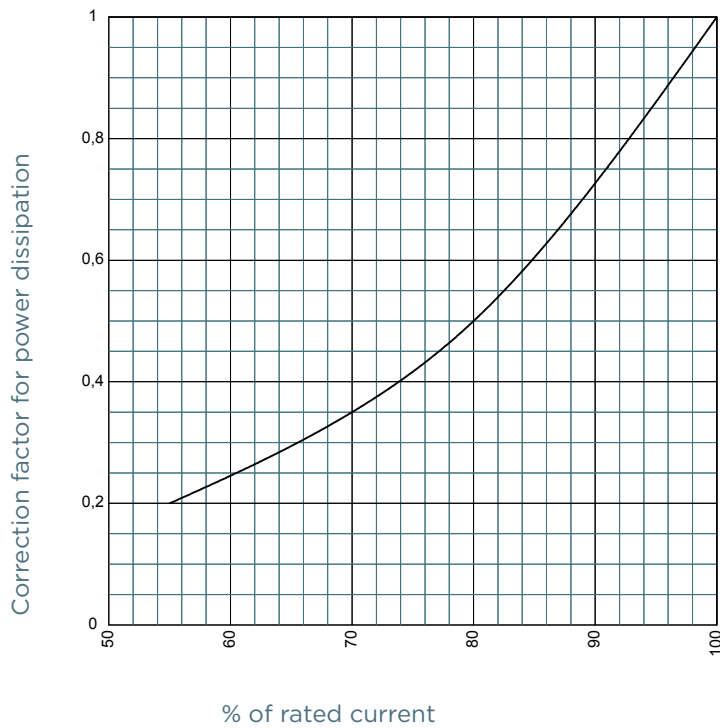

Mersen products have been designed by Mersen for a range of specific applications to be operated depending on particular specification and conditions. Mersen makes no representation or/and warranty, and waives any liability, either express or implied for products' reliability and life time or technical performance in case Mersen has not been provided with customer's specifications or if the products are not purchased directly from Mersen or its distributors and/or agents.

Protistor® size 2x72 and 2x73 aR

550 to 1250VAC (IEC)

PEAK ARC VOLTAGE

size 2x72 650V

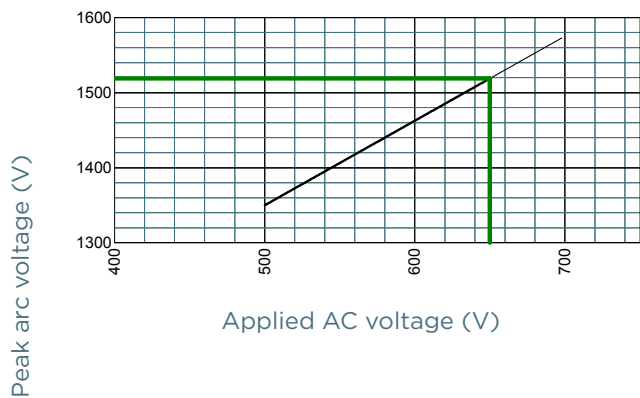

size 2x72 750V

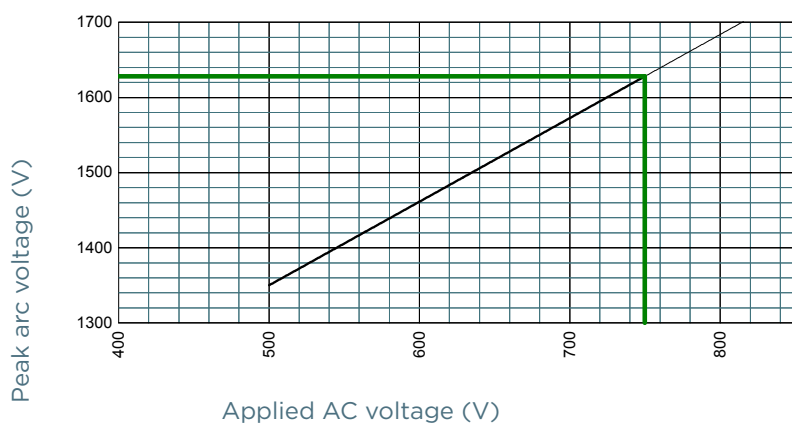

size 2x72 900V

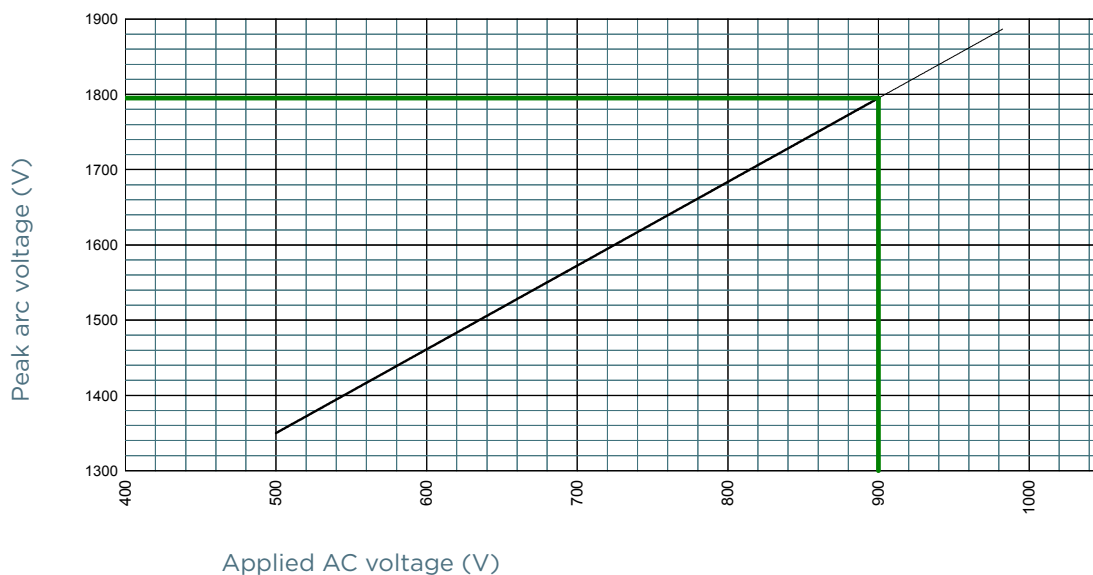

Protistor® size 2x72 and 2x73 aR

550 to 1250VAC (IEC)

PEAK ARC VOLTAGE

size 2x72 1000V

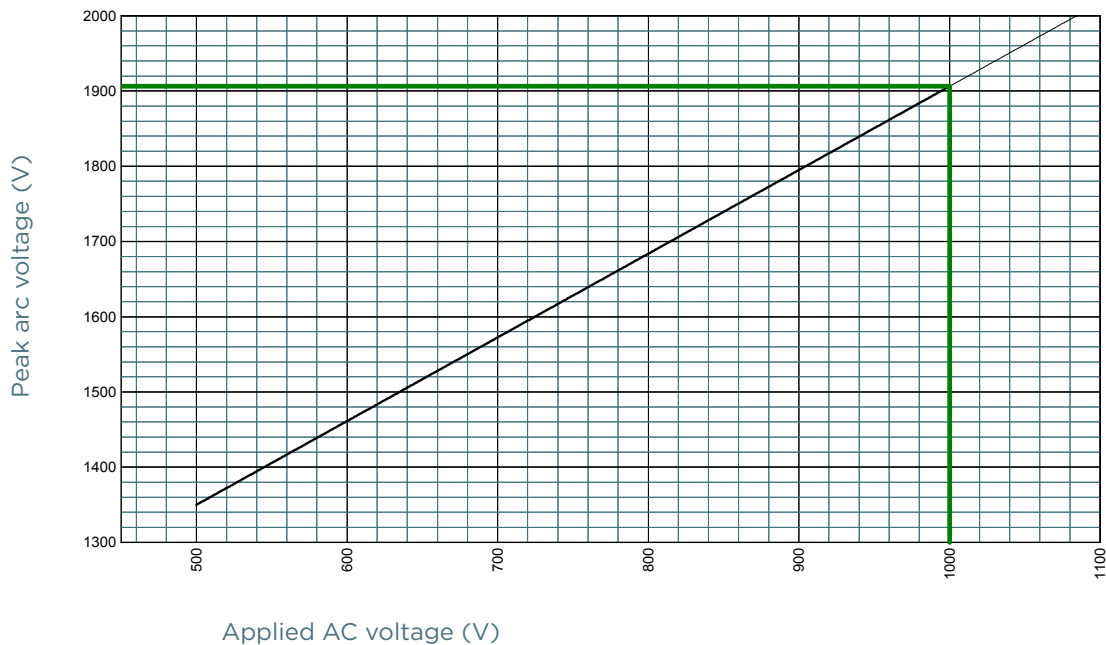

size 2x72 1100V

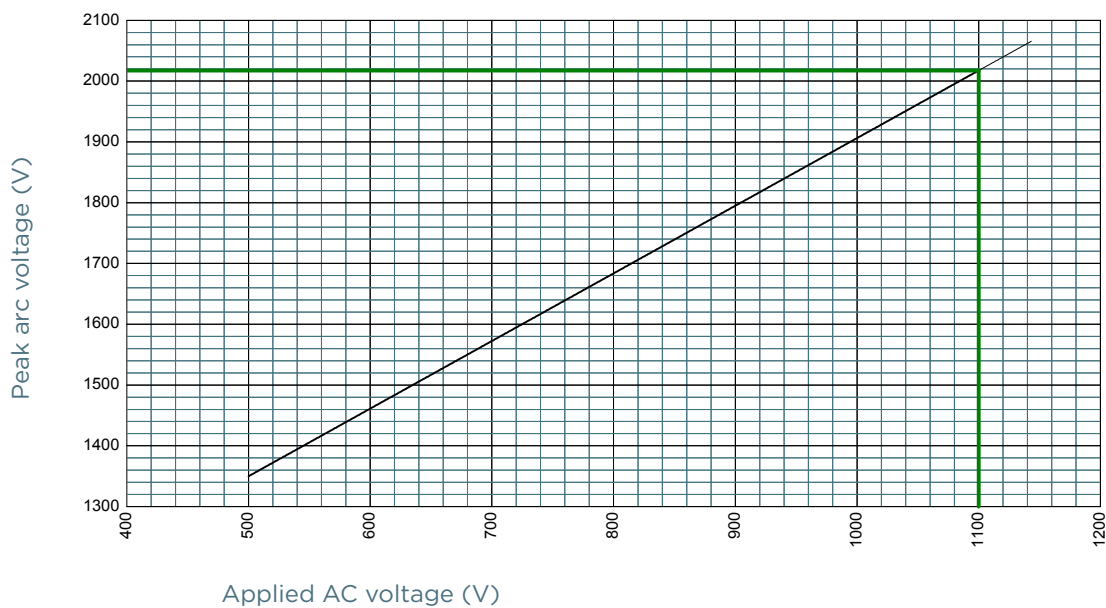

Mersen products have been designed by Mersen for a range of specific applications to be operated depending on particular specification and conditions. Mersen makes no representation or/and warranty, and waives any liability, either express or implied for products' reliability and life time or technical performance in case Mersen has not been provided with customer's specifications or if the products are not purchased directly from Mersen or its distributors and/or agents.

Protistor® size 2x72 and 2x73 aR

550 to 1250VAC (IEC)

PEAK ARC VOLTAGE

size 2x72 1250V

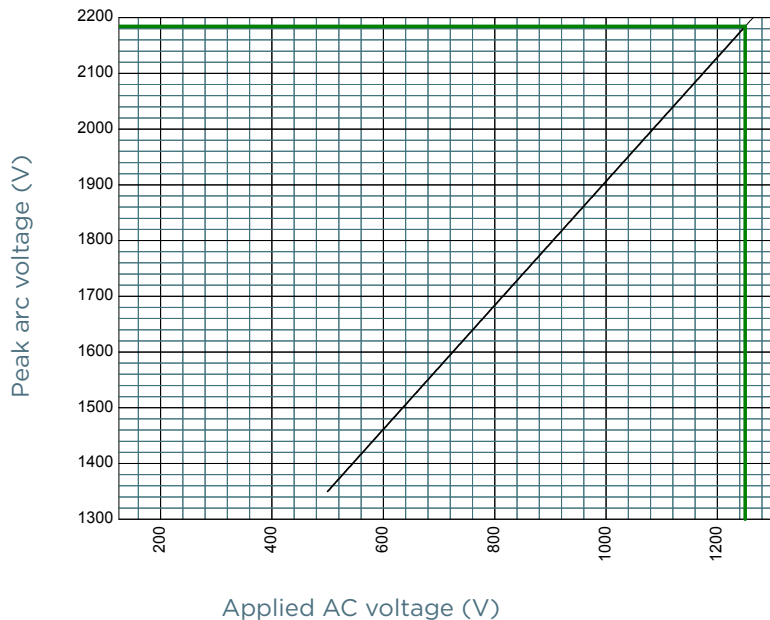

size 2x73 550V

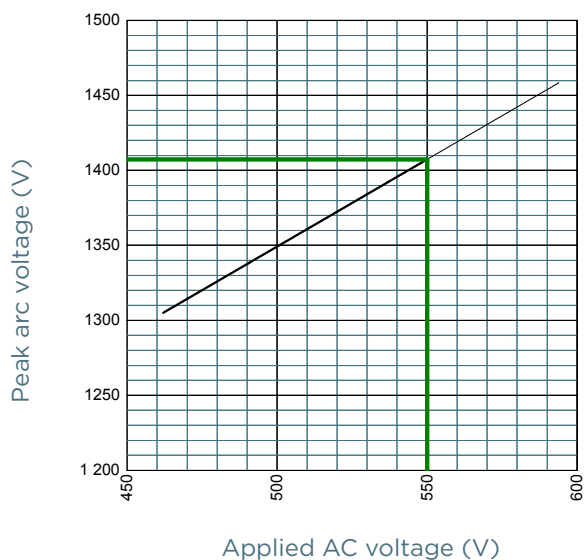

Mersen products have been designed by Mersen for a range of specific applications to be operated depending on particular specification and conditions. Mersen makes no representation or/and warranty, and waives any liability, either express or implied for products' reliability and life time or technical performance in case Mersen has not been provided with customer's specifications or if the products are not purchased directly from Mersen or its distributors and/or agents.

Protistor® size 2x72 and 2x73 aR

550 to 1250VAC (IEC)

PEAK ARC VOLTAGE

size 2x73 600V

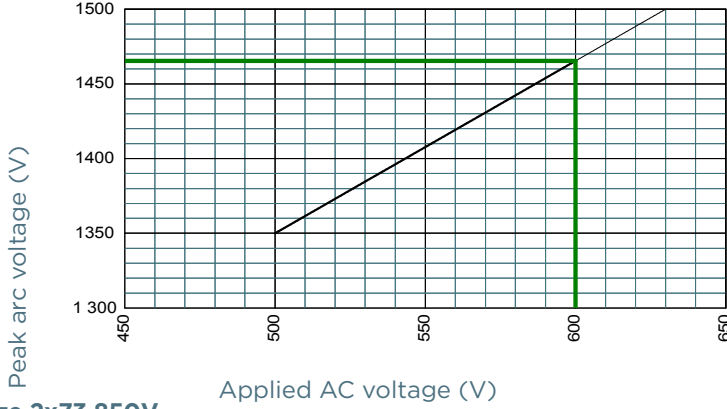

size 2x73 850V

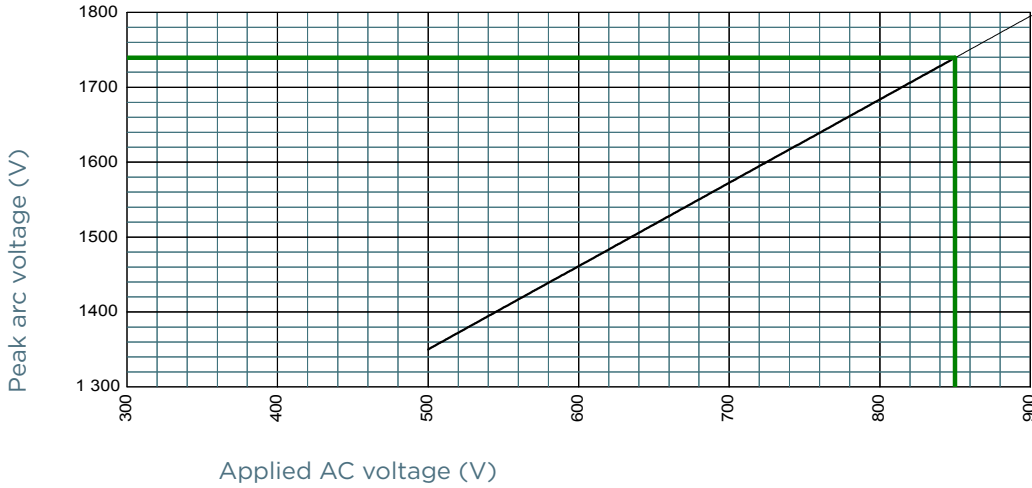

size 2x73 900V

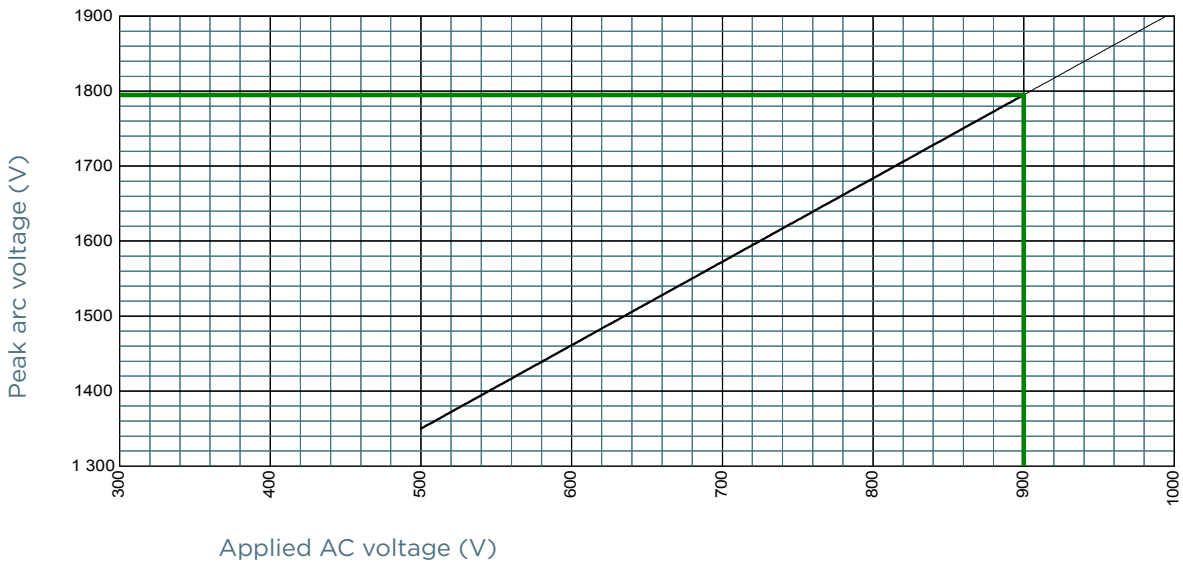

Mersen products have been designed by Mersen for a range of specific applications to be operated depending on particular specification and conditions. Mersen makes no representation or/and warranty, and waives any liability, either express or implied for products' reliability and life time or technical performance in case Mersen has not been provided with customer's specifications or if the products are not purchased directly from Mersen or its distributors and/or agents.

Protistor® size 2x72 and 2x73 aR

550 to 1250VAC (IEC)

PEAK ARC VOLTAGE

size 2x73 950V

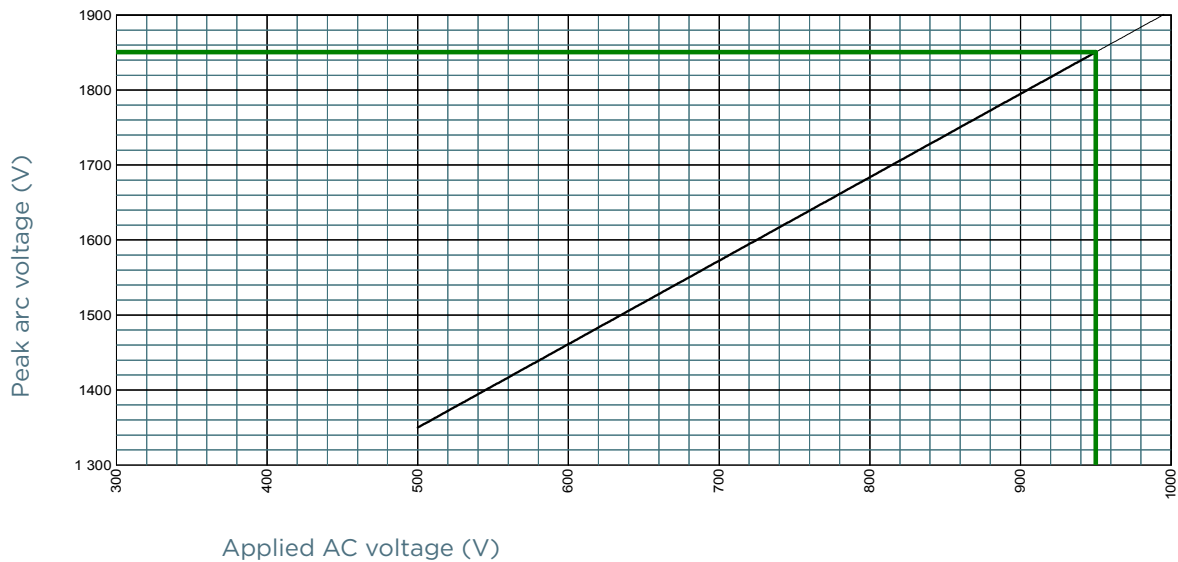

size 2x73 1000V

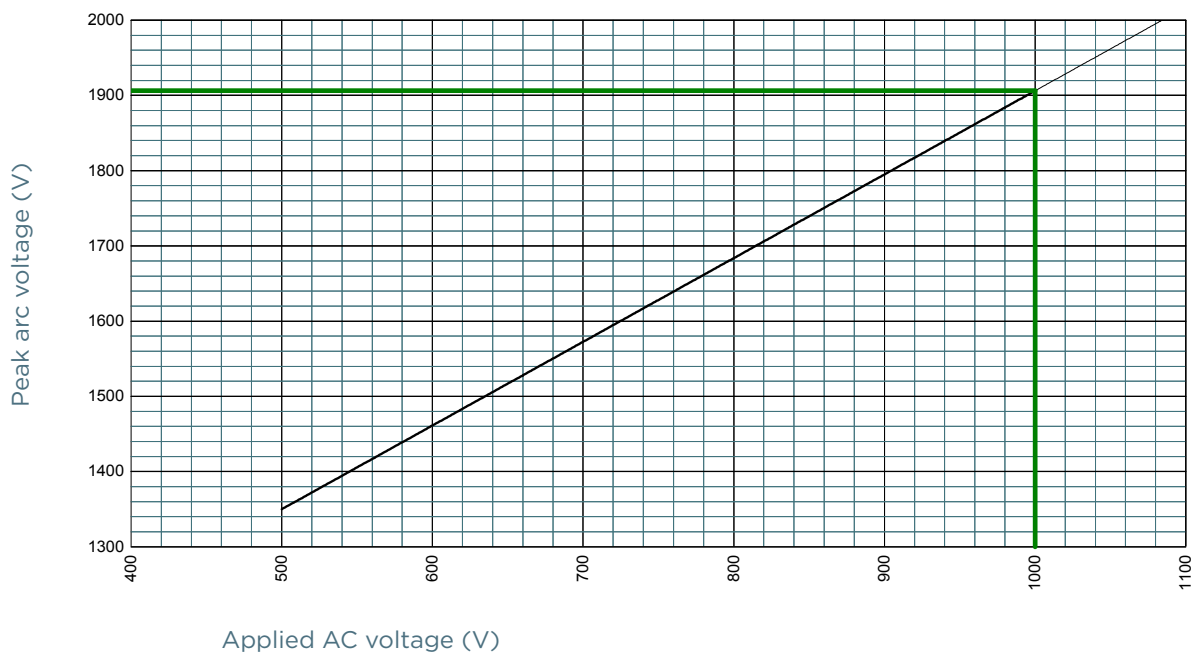

Mersen products have been designed by Mersen for a range of specific applications to be operated depending on particular specification and conditions. Mersen makes no representation or/and warranty, and waives any liability, either express or implied for products' reliability and life time or technical performance in case Mersen has not been provided with customer's specifications or if the products are not purchased directly from Mersen or its distributors and/or agents.

Protistor® size 2x72 and 2x73 aR

550 to 1250VAC (IEC)

PEAK ARC VOLTAGE

size 2x73 1100V

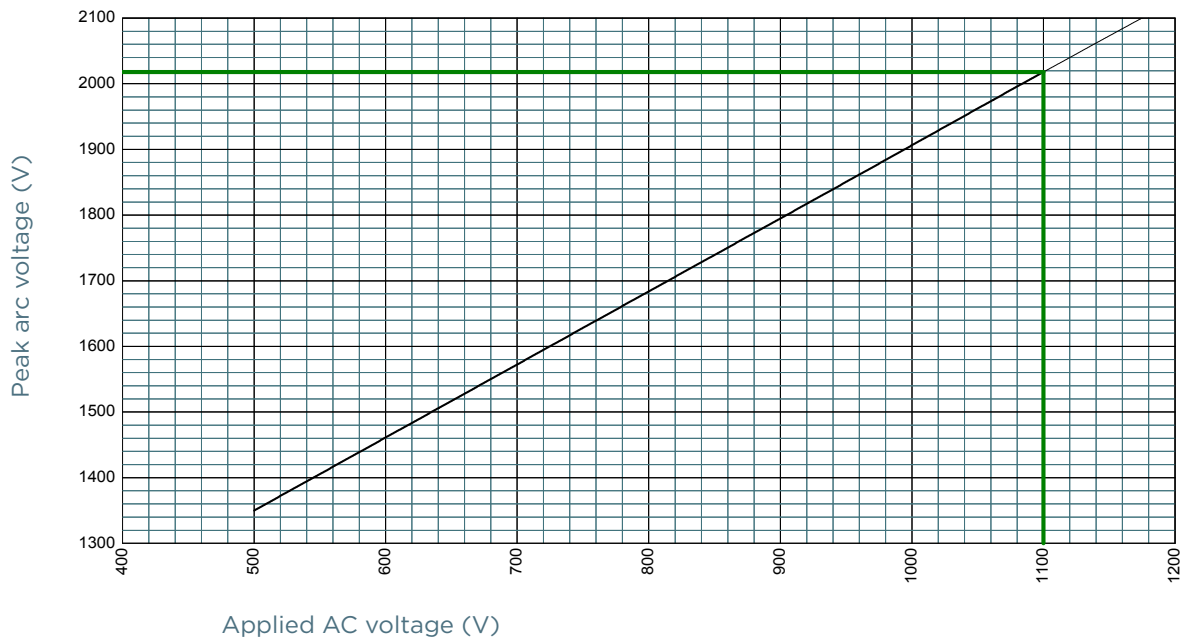

size 2x73 1250V

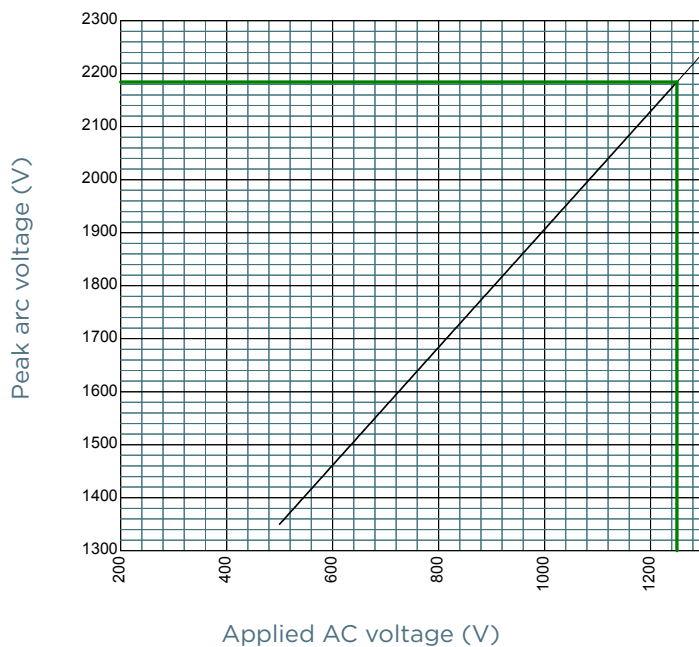

Mersen products have been designed by Mersen for a range of specific applications to be operated depending on particular specification and conditions. Mersen makes no representation or/and warranty, and waives any liability, either express or implied for products' reliability and life time or technical performance in case Mersen has not been provided with customer's specifications or if the products are not purchased directly from Mersen or its distributors and/or agents.

Protistor® size 2x72 and 2x73 aR

550 to 1250VAC (IEC)

DIMENSIONS

size 2x72 TTF (108171)

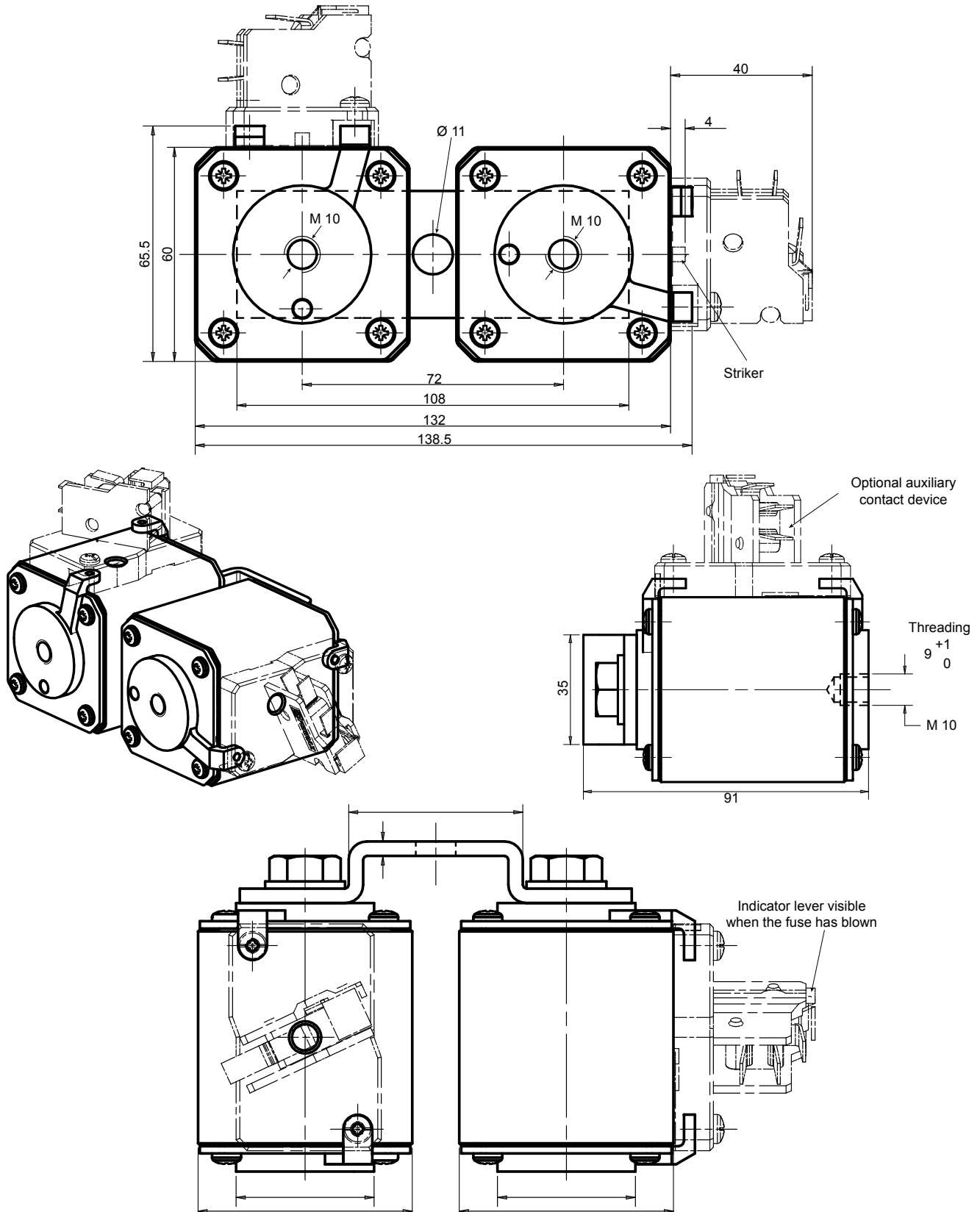

Dimensions in mm

Semiconductor Protection Fuses / DS-PFC67AB272-10-1221_EN

EP.MERSEN.COM

© 2021 Mersen. All rights reserved. Mersen reserves the right to change, adapt, limit or discontinue its products. Therefore the data provided herein are for information only and are not contractually binding. To ensure that Mersen provides the best solution to your needs, please contact and provide Mersen with all relevant technical specifications and conditions.

MERSEN
Expertise, our source of energy

Mersen products have been designed by Mersen for a range of specific applications to be operated depending on particular specification and conditions. Mersen makes no representation or/and warranty, and waives any liability, either express or implied for products' reliability and life time or technical performance in case Mersen has not been provided with customer's specifications or if the products are not purchased directly from Mersen or its distributors and/or agents.

Protistor® size 2x72 and 2x73 aR

550 to 1250VAC (IEC)

DIMENSIONS

size 2x73 TTF (108172)

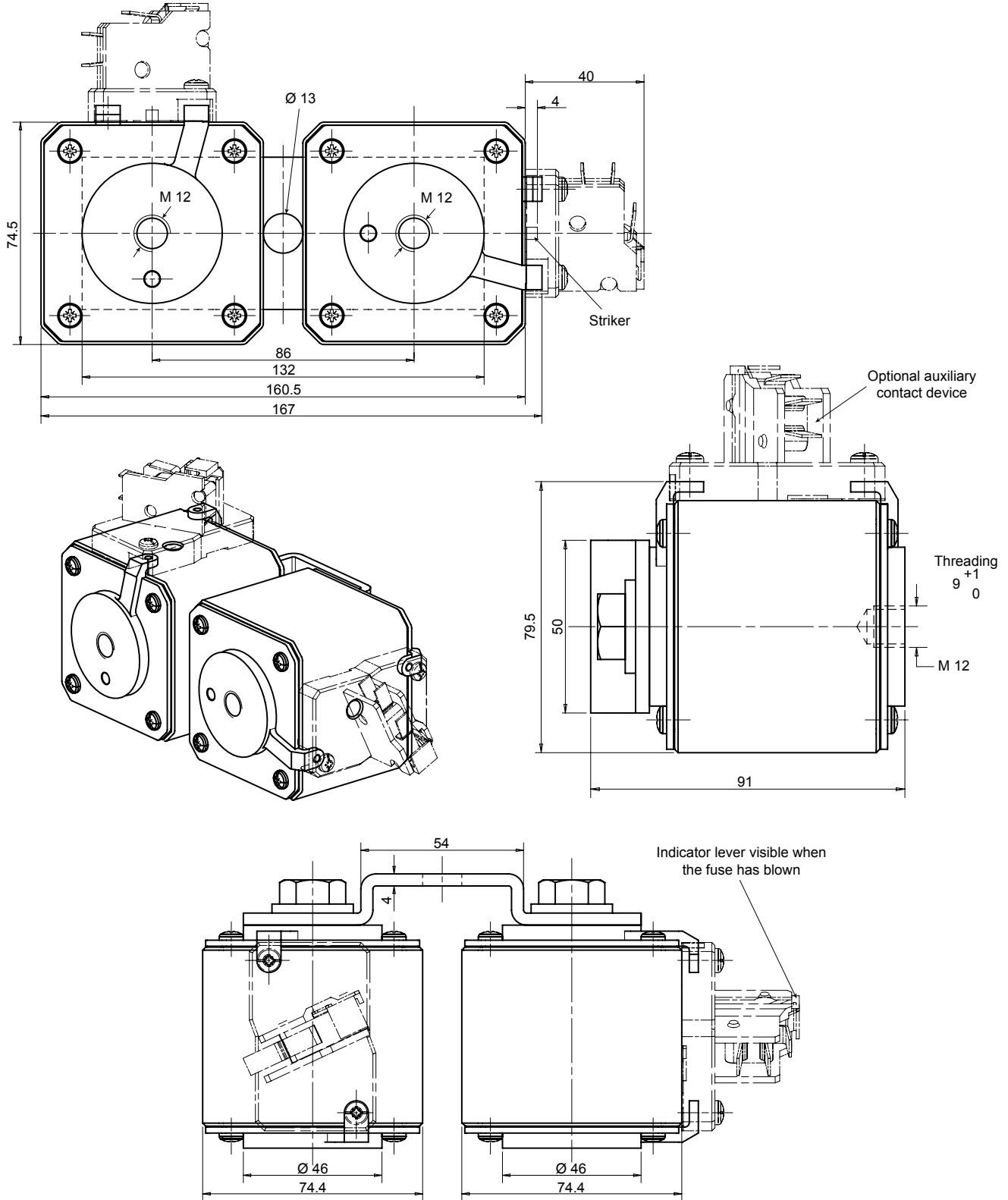

Dimensions in mm

Protistor® size 2x72 and 2x73 aR

550 to 1250VAC (IEC)

DIMENSIONS

size 2x73 PLAF (108170)

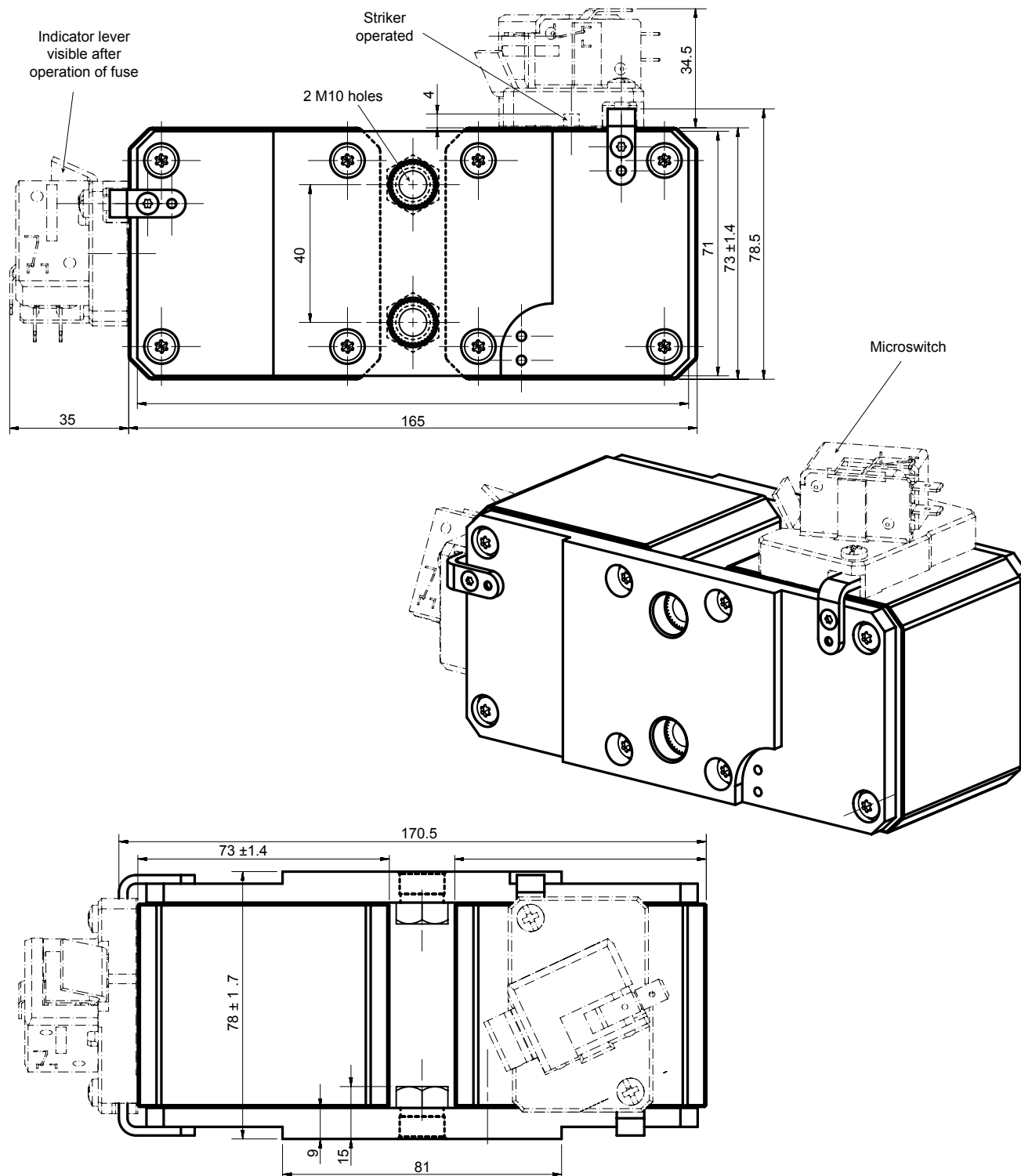

Dimensions in mm

Protistor® size 2x72 and 2x73 aR

550 to 1250VAC (IEC)

APPENDIX

Index

Catalog number	Item number	Description 1	Page
PC272UD13C630TF	W300721	12,5 URD 272 TTF 0630	2
PC272UD13C700TF	X300722	12,5 URD 272 TTF 0700	2
PC272UD13C800TF	Y300723	12,5 URD 272 TTF 0800	2
PC272UD13C900TF	Z300724	12,5 URD 272 TTF 0900	2
PC272UD13C10CTF	A300725	12,5 URD 272 TTF 1000	2
PC272UD13C11CTF	B300726	12,5 URD 272 TTF 1100	2
PC272UD11C13CTF	M302231	11 URD 272 TTF 1250	2
PC272UD11C14CTF	D300728	11 URD 272 TTF 1400	2
PC272UD10C16CTF	L302230	10 URD 272 TTF 1600	2
PC272UD90V18CTF	E301994	9 URD 272 TTF 1800	2
PC272UD75V20CTF	F301995	7,5 URD 272 TTF 2000	2
PC272UD65V22CTF	G301996	6,5 URD 272 TTF 2200	2
PC272UD65V25CTF	H301997	6,5 URD 272 TTF 2500	2
PC273UD13C800TF	F300730	12,5 URD 273 TTF 0800	2
PC273UD13C900TF	G300731	12,5 URD 273 TTF 0900	2
PC273UD13C10CTF	H300732	12,5 URD 273 TTF 1000	2
PC273UD13C11CTF	J300733	12,5 URD 273 TTF 1100	2
PC273UD13C13CTF	K300734	12,5 URD 273 TTF 1250	2
PC273UD11C14CTF	K302229	11 URD 273 TTF 1400	2
PC273UD11C16CTF	J302228	11 URD 273 TTF 1600	2
PC273UD11C18CTF	S302236	11 URD 273 TTF 1800	2
PC273UD10C20CTF	P300738	10 URD 273 TTF 2000	2
PC273UD95V22CTF	Q300739	9,5 URD 273 TTF 2200	2
PC76UD95V22CP11	M301909	9,5 URD 273 PLAF 2200	3
PC76UD90V25CP11	R300740	9 URD 273 PLAF 2500	3
PC76UD85V28CP11	S300741	8,5 URD 273 PLAF 2800	3
PC76UD60V30CP11	K301999	6 URD 273 PLAF 3000	3
PC76UD60V32CP11	M302001	6 URD 273 PLAF 3200	3
PC76UD55V36CP11	N302002	5,5 URD 273 PLAF 3600	3

Mersen products have been designed by Mersen for a range of specific applications to be operated depending on particular specification and conditions. Mersen makes no representation or/and warranty, and waives any liability, either express or implied for products' reliability and life time or technical performance in case Mersen has not been provided with customer's specifications or if the products are not purchased directly from Mersen or its distributors and/or agents.