

Coating Thickness Testers

LE-200J/LH-200J/LZ-200J



Operating Manual

Thank you for purchasing this product.
Please read the operating manual carefully and use this product properly.

For safety precautions

Improper use of the Coating Thickness Tester in violation of the following safety notes may result in death, injury or damage to property due to fire, etc. While the safety of the product has been given considerable attention, read the precautions in the operating manual and use the instrument properly.

■ Observe the safety precautions.

Read the precautions noted in the operating manual.

The safety measure of the unit may be impaired if instructions are ignored during use.

■ Do not use if broken.

If you suspect a problem or malfunction in the unit, make sure to contact the vendor.

■ Meaning of warning symbols.

In order to prevent damage resulting from erroneously operating the equipment, the following symbols are indicated in the operating manual and on the product. These symbols have the following meanings.

	Caution	Failure to observe these items may lead to injury to the user or damage to property.
--	----------------	--

Contents

1. Measuring Principles and Characteristics	4
2. Instrument view	6
3. Accessories	7
4. Keypad Functions	8
5. Specifications.....	11
6. Preparations for Operation	12
7. Measuring Procedure	21
8. Functions	25
9. Master Calibration.....	31
10. Notes for Measuring and Handling	32

1. Measuring Principles and Characteristics

- The model LE-200J electromagnetic coating thickness tester is designed to measure the thickness of non-magnetic coatings such as paint or plating on magnetic metal substrates (iron or steel).
- The model LH-200J Eddy Current coating thickness tester is designed to measure the thickness of insulating coatings such as alumite or paint on non-magnetic metal substrates (such as aluminum or copper, etc.).
- The model LZ-200J dual-type coating thickness tester is designed to measure the thickness of either non-magnetic or insulating coatings on either magnetic or non-magnetic metal substrates.

Applicable Coatings

Model	LZ-200J			
	LE-200J		LH-200J	
Applicable Coatings	Paint	Plastic	Paint	Alumite
	Lacquer	Resin	Rubber	Plastic
	Rubber	Enamel	Enamel	Lacquer
	Lining	Zinc	Resin	Other
	Chrome	Tin		
	Copper	Aluminum		
	Other			
Substrate	Iron Steel		Aluminum, Copper, Brass, etc.	

• **LE-200J**

(Electromagnetic measurement method : For measuring the thickness of non-magnetic coatings on magnetic metal substrates)

When an alternating current electromagnet is brought near iron (or other magnetic metal) the number of magnetic flux lines passing through the coil changes in proportion to the distance, thereby causing a change in the voltage at the ends of the coil. This change in voltage is determined from the current value and this is used to compute the thickness of the coating.

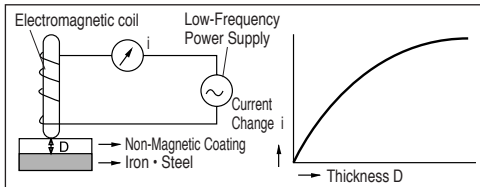

• **LH-200J**

(Eddy Current measurement method: For measuring the thickness of insulating coatings on non-magnetic metal substrates)

An eddy current is produced in the surface of a metal when a coil through which a current of fixed frequency is brought near the metal. This eddy current and the voltage at the ends of the coil change in proportion to the distance between the coil and the metal surface. This change can be determined from the current value and this is used to calculate the thickness of the coating.

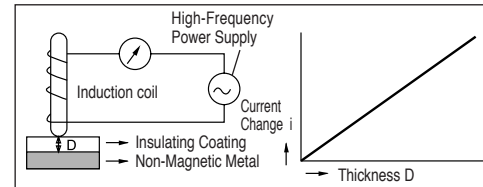

• **LZ-200J (Dual Electromagnetic and Eddy Current Type)**

The model LZ-200J is a dual type coating thickness tester which features both the electromagnetic and Eddy Current measurement methods.

2. Instrument view

<Main part>

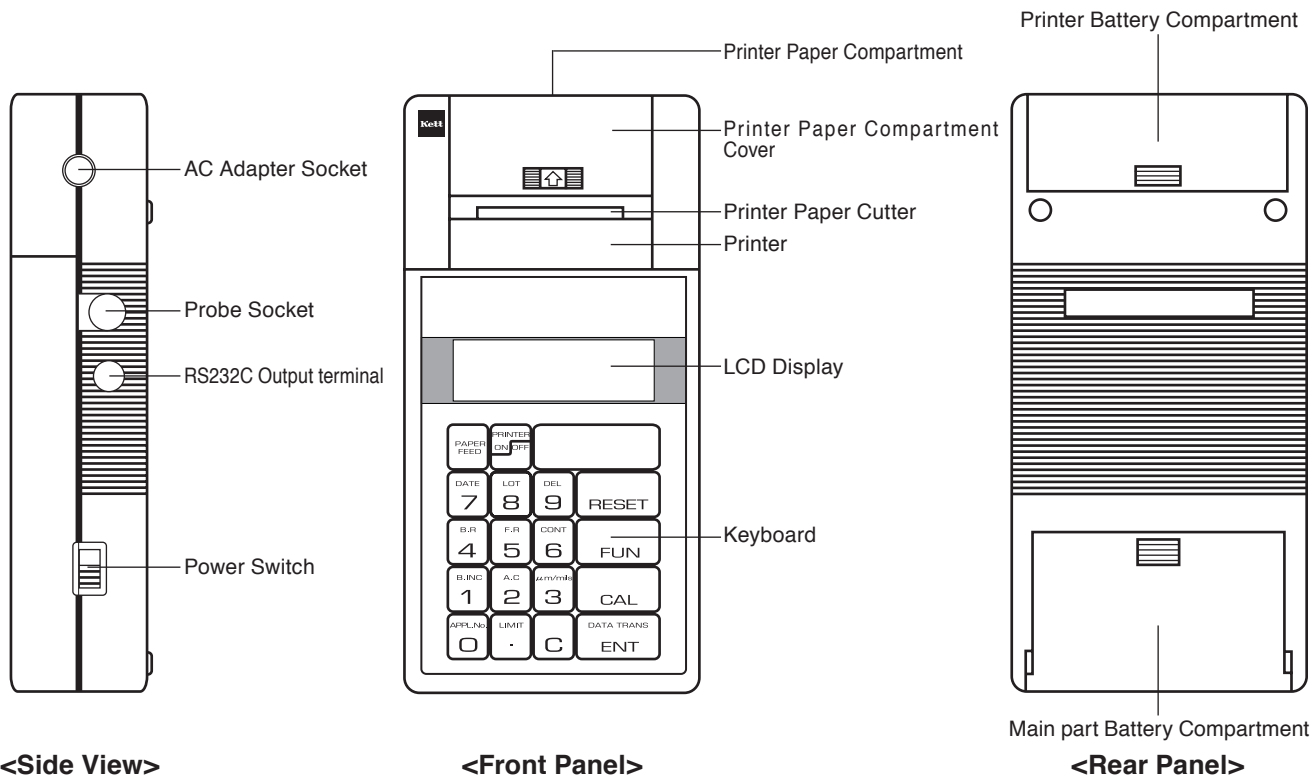

3. Accessories

<Probe>

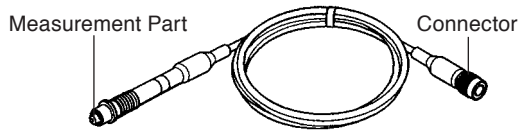

Fe Probe (Black) Electromagnetic (LEP-J)

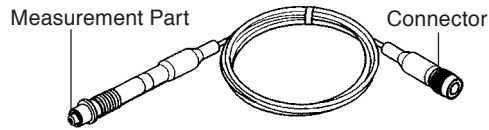

NFe Probe (Gray) Eddy Current (LHP-J)

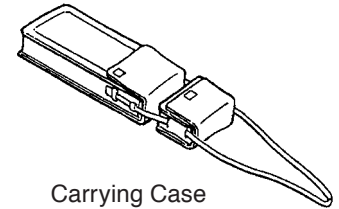

Carrying Case

<Accessories>

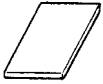

Iron Substrate (FE-J)
(For LE-200J,LZ-200J)

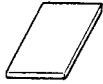

Aluminum Substrate (NFE-J)
(For LH-200J,LZ-200J)

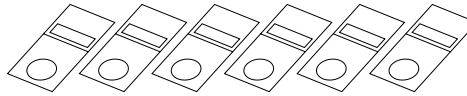

Standard Calibration Foils (6pcs)

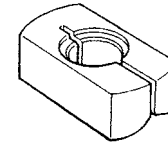

Probe Adaptor

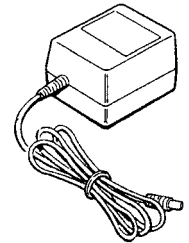

AC Adapter

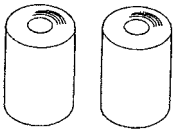

Printer Paper

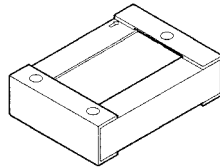

Calibration Foilcase

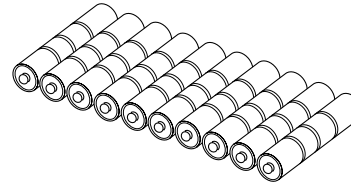

Batteries size AA (10pcs)

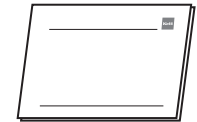

Operating Manual

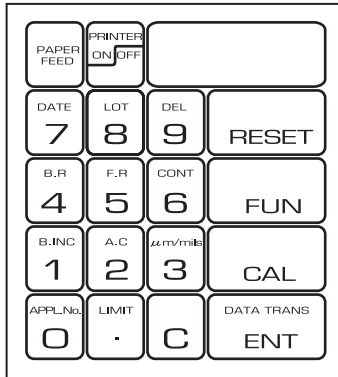

4. Keypad Functions

















Dual-function Keys : The following keys also have a thing with two functions.



These are called function mode key. These keys are pressed immediately after presetting a function key. A result -- as a function mode key -- functioning.

Key	Name	Function
	RESET key	In order to reduce power consumption, the LE-200J • LH-200J • LZ-200J automatically go into the Sleep Mode and "SLEEP" will be displayed on the LCD if the unit is left unused for more than 10 minutes with the power on. The Reset Key is pressed to turn to the measurement mode.
	CALIBRATION key	The CAL key is pressed to perform the calibration adjustment.
	ENTER key	The Enter key is used to input numeric values when performing the DATE, LOT, CAL, DEL and LIMIT operations. This key is also used to move to the next step when using BR, FR, BINC and AC.

Key	Name	Function
	PAPER FEED key	The Paper Feed Key is used to feed out printer paper.
	PRINTER ON/OFF key	This key used to turn the printer on and off. Lightly pressing this key will turn on the printer's power and the asterisk ("*") mark in the LCD display will change to sharp ("#"). When measurements are made while this mark appears in the display, measured values will be printed out. Press this Key again to turn the printer off.
	CLEAR key	This key is used to clear incorrectly numeric data.
	FUNCTION key	This key is pressed to use the double-definition key function modes (date, lot number statistical results, etc.). The LE-200J • LH-200J • LZ-200J features the function modes described below.
	DATE key	This key is used to input (print) the date.
	LOT key	This key is used to input (print) the lot number.
	DELETE key	This key is pressed to erase the measurement data of incorrectly performed measurements from the data memory.

Key	Name	Function
	BLOCK RESULTS key	This key is pressed to perform statistical calculations for each block.
	FINAL RESULTS key	This key is pressed to obtain statistical results from measurement number N = 1 to the final measurement number.
	CONTINUE key	This key is used to convert the measurement values display between the Hold Mode and Continuous Monitoring Mode.
	BLOCK INCREMENT key	This key is pressed to change the block number.
	ALL CLEAR key	This key is pressed to clear all measurement data and comments from memory.
	UNIT SELECTION key	This key is used to select between μm and mils and measurement units.
	APPLICATION NUMBER key	This key is pressed to check and/or change the number at which calibration parameters are memorized.
	LIMIT key	This key is pressed to set upper and lower measurement values limits.

5. Specifications

Model	LZ-200J	
	LE-200J	LH-200J
Measurement Method	Electromagnetic	Eddy Current
Probe Type	LEP-J(Fe)	LHP-J(NFe)
Object of Measurement	Non-magnetic coatings on iron and steel substrates	Insulating coating on non-magnetic metal substrates
Measurement Range	0 ~ 1500 μ m or 60.00mils	0 ~ 800 μ m or 32.00mils
Measurement Units	μ m or mils (selectable)	μ m or mils (selectable)
Measurement Precision	Under 15 μ m : \pm 0.3 μ m (absolute error) 15 μ m or greater : \pm 2% (relative error)	Under 50 μ m : \pm 1 μ m (absolute error) 15 μ m or greater : \pm 3% (relative error)
No. of Calibration Parameter Memories	4	4
Resolution	0.1 μ m (less than 100 μ m) 1 μ m (100 μ m or greater)	1 μ m
Min. Measurement Surface Area	3 x 3mm	5 x 5mm
Display	16-digit dot-matrix LCD	
Statistical Functions	No. of measurements, number of block numbers, average value, standard deviation, maximum value, minimum value	
Data Memory Capacity	Coating data : 1,500 items No. of blocks per lot : 99	
Printer	24-character thermal printer with 58mm paper width	
Power Supply	100V AC (50/60Hz) or Batteries 6pce size "AA" (main unit) Batteries 4pce size "AA" (printer)	
Operating Temperature	0 ~ +40°C	
Main Unit Weight	Net : 1.1kg Shipment : 2.5kg	
Dimensions	Main Unit : 120(W) x 250(D) x 55(H)mm Probe : ϕ 11 x 90mm	
Accessories	Carrying Case, Iron Substrate (FE-J For LE/LZ-200J), Aluminum Substrate (NFE-J For LH/LZ-200J), Standard Calibration Foils x 6, Probe Adaptor, AC Adapter, Printer Paper, Calibration Foilcase, Batteries (size AA) x 10, Operating Manual	

6. Preparations for Operation

1. Measurement Preparations

Preparing the power source

The LE-200J • LH-200J • LZ-200J have been designed for use with either 100V/220V AC 50/60 Hz or dry cell batteries as the power supply.

- **Running the LE-200J • LH-200J • LZ-200J on a 100V/220V AC power supply**

Turn the main unit's power switch off and insert the plug of the supplied AC adapter into the AC adapter Socket on the right side of the main unit. Next connect the AC adapter to a 100V/220V power supply socket.

- **Running the LE-200J • LH-200J • LZ-200J • on dry cell batteries**

Turn the main unit's power switch off and then insert batteries into the rear battery compartments.

Main Unit section : 1.5V (size AA alkaline batteries) x 6

Printer section : 1.5V (size AA alkaline batteries) x 4

Only use alkaline batteries. tting at the end

- **Running the LE-200J • LH-200J • LZ-200J on both an AC power supply and dry cell batteries**

When the AC adapter plug is connected to the unit's AC Adapter Socket with dry cell batteries loaded into the compartment the unit will automatically switch over to the AC power supply.

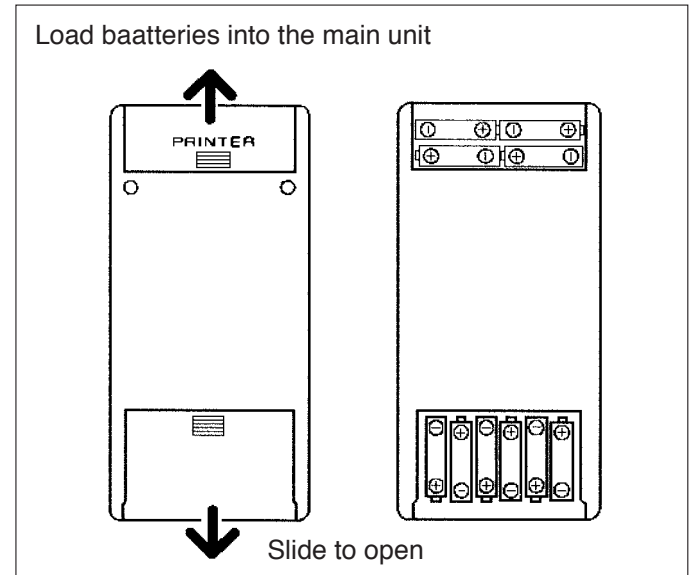

2. Loading Battery in the probe

Use the LEP-J (Fe) probe to measure the thickness of non-magnetic coatings on magnetic metal surface or the LHP-J (NFe) probe to measure insulating coatings on non-magnetic metal surface.

- The probe can be easily connected to the main unit by turning it a little while softly pressing it into the probe socket on the right side of the main unit.
- When removing the probe from the main unit, always be sure to grasp the metal fitting at the end of the probe cord connected to the main unit. Note that the probe cannot be disconnected by pulling on the black portion of the cord.

3. Turning on the Power Switch

The power is turned on by sliding the power switch on the right side of the main unit upwards. The type of probe being used and the calibration parameters last used are displayed on the LCD panel.

• Example : LZ-200J

*FE APPL. No = 1
(Electromagnetic format (FE), Calibration Position (1))

*NF APPL. No = 2
(Eddy Current format (NF), Calibration Position (2))

Connecting the probe

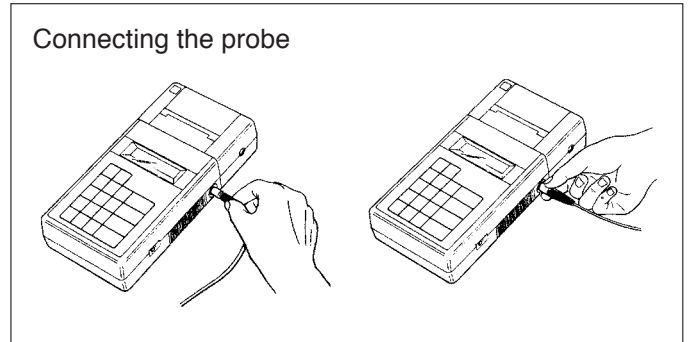

4. Inserting Printer Paper

- After removing the paper compartment cover, cut the edge of the printer paper with a pair of scissors, etc., so that the paper has a clean edge and then insert the edge fully into the printer through the guide slot in the printer compartment.
- Next press the PAPER FEED button to feed the paper out through the printer.
- If you wish to print out measurement data or the date, etc., turn on the printer by lightly pressing the PRINTER ON/OFF. The asterisk mark ("*") in the LCD panel will switch to a sharp mark ("#") to indicate that the printer is on and ready to use.

5. Adjustment preparation

Adjustments must be made attempting to make measurements. However, measurement calibrations are stored in the unit's computer memory, therefore new adjustments are not required if the sample to be measured has been measured previously. In this case, the previous adjustments can be recalled from memory.

- ① A standard "substrate" of the same material, shape and thickness as the sample to be measured is used to make calibration adjustments. Have the standard substrate ready before beginning the adjustment procedure.
 - Use bare standard substrates which are free of coatings such as plating or paint. Standard substrates of this type are referred to as "zero foils" in this manual.
- ② In order to obtain the most accurate precise measurement results possible, adjustments are performed with zero foils and standard foils (samples of known thickness) using the Standard Foil 4-point Adjustment Method.
 - Refer to the chart to select a set of 3 standard foils appropriate for making adjustments for the thickness of the coating to be measured.

<Standard Foil Combination Example>

- The supplied standard foil values will not necessarily be exactly the same as those indicated in the chart. Instead, standard plates with actually measured values close to these values are supplied.
- An attached standard board is used for an easy accuracy check.

Measuring Range	Adjustment point (Electromagnetic)				Measuring Range	Adjustment point (Eddy Current)			
	Iron substrate	10 μ m	25 μ m	50 μ m		Aluminum substrate	10 μ m	25 μ m	50 μ m
0~50 μ m	Iron substrate	10 μ m	25 μ m	50 μ m	0~50 μ m	Aluminum substrate	10 μ m	25 μ m	50 μ m
50~500 μ m	Iron substrate	50 μ m	100 μ m	500 μ m	50~300 μ m	Aluminum substrate	50 μ m	100 μ m	300 μ m
500~1500 μ m	Iron substrate	500 μ m	1000 μ m	1500 μ m	300~800 μ m	Aluminum substrate	350 μ m	500 μ m	800 μ m

6. Using the probe

The probe features a 1-point contact, fixed pressure design which ensures fixed load applied the chip on the tip the probe. As shown in the diagram, grip the probe near the tip and press it against the measurement surface so that it is perpendicular to the surface. To make the next measurement, lift the probe tip at least 10mm from the measurement surface and then press it down again.

- The probe adapter can be used to obtain stable, reliable measurements when measuring coatings on curved surfaces such as pipes , etc., or when making continuous measurements on a flat surface.

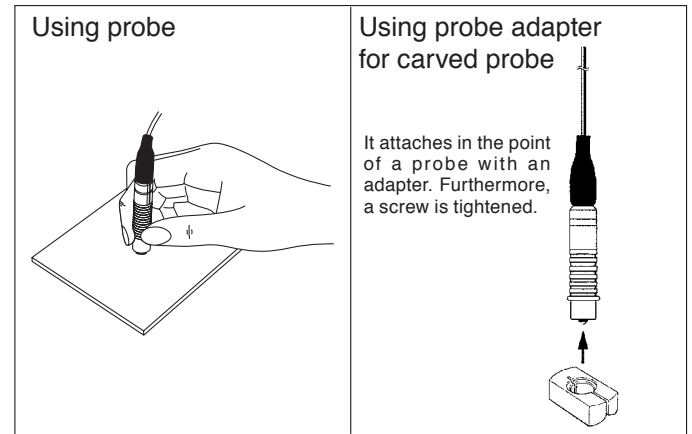

7. Calibrating the LE-200J • LH-200J • LZ-200J





The LE-200J • LH-200J • LZ-200J can store up to 4 sets each of calibration parameters for both the electromagnetic and high-frequency measurement formats.

Decide which application number you wish to store a particular set of calibration parameters in before performing the calibration procedure.

In order to obtain stable precision, we recommend that you perform 10 to 20 practice measurements to calibrate the unit after turning its power on.







1) The calibration Parameters application number (APPL. No.) is specified. Allowable application numbers are from 1 to 4.

• Example : Set the Application Number to 4. Use the LHP-J probe when making this setting.



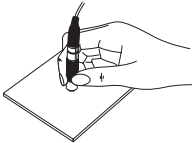

Step	Operation	Display
①		* FUNCTION KEY
②		* APPL.No=(1~4)? (Number displayed is the previous application number)
③		* APPL. No=4
④		* NF (Input complete)
		*** APPL.No=4 *** (Printout)

2) Performing Calibration



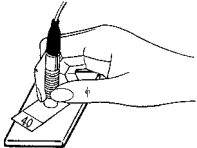

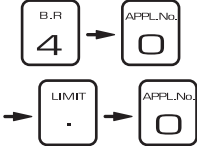

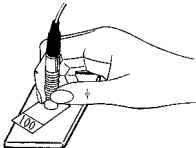

- Example: Performing calibration using the zero foil and standard foils (40, 100 and 400 μ m foils).

Step	Operation	Display	Explanation
⑤		* MASTER INF.	Press the  key.
⑥		* ZERO	Press the  key while holding the probe toward the air.
⑦	<p><Calibration using the zero foil> (Measure 5 times)</p> 	<p>① * ZERO 0.1 ..</p> <p>② * ZERO 0.5 ..</p> <p>•</p> <p>•</p> <p>•</p> <p>•</p> <p>⑤ * ZERO 0.1 ..</p>	<p>Measure the (substrate) 5 times. The buzzer will sound and the measured value will be displayed each time.</p> <ul style="list-style-type: none"> • Substrate: An uncoated (no plating, paint, etc.) sample of the same shape and material as that to be measured. • Depending upon the type of material, the value displayed may differ greatly from that indicated in the example to the left (a value close to zero). However, the procedure can be continued by setting it close to the setting value by performing steps ⑧.
⑧		* STD1	Press the  key while holding the probe toward the air.





<Calibration using the standard foil (40 μ m)>



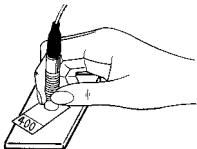

Step	Operation	Display	Explanation
⑨	(Measure 5 times) 	① * STD1 40.1.. ② * STD1 40.5.. ⑤ * STD1 39.9..	Place the 40 μ m calibration foil on the substrate and repeat the measurement procedure 5 times. • Depending upon the type of material, the value displayed may differ greatly from that indicated in the example to the left. However, you can continue the procedure by setting it near the setting value by performing steps ⑩ ⑪ and ⑫.
⑩		* d=? ..	Press the  key while holding the probe toward the air.
⑪		* d=40.0? ..	Input the coating thickness of the calibration foil (40.0 μ m).
⑫		* STD2	Press the  key while holding the probe toward the air.

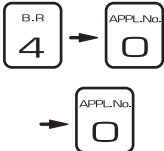
<Calibration using the standard foil (100 μ m)>

Step	Operation	Display	Explanation
⑬	(Measure 5 times) 	① * STD2 101 .. ② * STD2 100 ⑤ * STD2 99.9..	Place the 100 μ m standard foil on the zero foil (substrate) and repeat the measurement procedure 5 times. • Depending upon the type of material, the value displayed may differ greatly from that indicated in the example to the left. However, you can continue the procedure by setting it near the setting value by performing steps ⑭ ⑮ and ⑯.
⑭		* d=? ..	Press the  key while holding the probe toward the air.
⑮	 →  	* d=100? ..	Input the coating thickness of the calibration foil (100.0 μ m).
⑯		* STD3	Press the  key while holding the probe toward the air.

<Calibration using the standard foil (400 μ m)>

Step	Operation	Display	Explanation
⑰	(Measure 5 times) 	① * STD3 401 ■ ② * STD3 400 ■ ● ● ● ● ⑤ * STD3 401 ■	Place the 400 μ m standard foil on the substrate and repeat the measurement procedure 5 times. • Depending upon the type of material, the value displayed may differ greatly from that indicated in the example to the left. However, you can continue the procedure by setting it near the setting value by performing steps ⑱ ⑲ and ⑳.
⑱		* d=? ■	Press the  key while holding the probe toward the air.
⑲		* d=400? ■	Input the coating thickness of the calibration foil (400.0 μ m).
⑳		* FE	Press the  key while holding the probe toward the air. Input of calibration parameters for application No.4 is complete.

- 5 measurements are made at each stage of the zero and calibration foil adjustment procedure in order to obtain the average measurement value.
- If you make errors while entering numeric values during the calibration procedure, press the  key to delete the value and then input the correct value. However, please note that corrections cannot be made after the  key has been pressed. If you press the  key after entering incorrect values, press the  key resume the procedure from step ⑤.

7. Measuring Procedure

(1) Select & Connect the probe

In the LZ-200J, select the appropriate type of probe for the type of material to be measured. (⇒ P. 6,13)

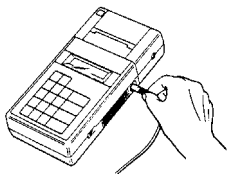

(2) Turn on the main unit's power

Press the ON key.

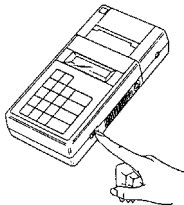

(3) Adjustment

Before beginning a measurement, check to see if the unit has been calibration for measurement of that type of material. If calibration has not been performed, perform the calibration operation and register the calibration settings. (⇒ P. 14)

(4) Delete contents of the measurement value memory

Except in cases in which you wish to continue making measurements with data acquired previously, you must delete the entire contents of the measurement value memory. (⇒ P. 26)



(5) Connect the printer

Connect the printer to the unit if you wish to print out results while performing measurement and other operations. (It is also possible to connect the unit to a printer after completing measurements and print out the measurement values and the results of statistical calculations. (The printer is an optional accessory.)

The LCD panel will repeatedly switch between displaying the asterisk (*) and sharp (#) marks when the PRINTER ON/OFF key is pressed continuously. The printer is ready for use when the sharp (#) is shown in the display.

(6) Specify calibration settings

Specify the calibration memory address of calibration settings registered for the type of material being measured. (⇒ P. 15)

Example: Set the Application Number to 4.



(7) Enter comments such as the date and lot number, etc.

Commentary information which can be entered includes the date, lot number, and upper and lower measurement value limits. This information is input as necessary. (⇒ P. 24,25)

- Example: Inputting lot number 125



(8) Measurement

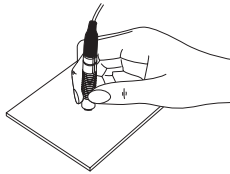

Quickly press the probe against the surface to be measured in such a way that the probe is perpendicular to the surface. The next measurement can be performed after first removing the tip of the probe at least 10mm from the surface being measured.

(9) Data Processing (Statistical Processing)

- Example: Lot Statistical Calculations

AV: Average value SD: Standard deviation MAX: Maximum value MIN: Minimum value

1. Performing calculations without using a printer

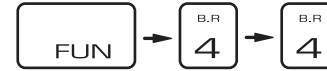

2. Printing out the results when connected to a printer



3. Batch transmission of data to the printer

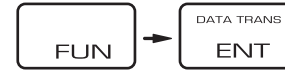

- Data can also be transmitted to a computer in the same way.

(10) Converting Measurement Value Display Units

This function mode is used to switch between μm and mils as the unit of measurement. (⇒ P. 26)



(11) Typical Measurement Example











Operation	Display	PrintOut																												
① <table border="1" style="display: inline-table; vertical-align: middle;"> <tr> <td>FUN</td><td>DATE</td><td>APPL.No</td><td>μm/mils</td><td>LIMIT</td><td>B.INC</td><td>APPL.No</td> </tr> <tr> <td></td><td>7</td><td>0</td><td>3</td><td>.</td><td>1</td><td>0</td> </tr> <tr> <td>LIMIT</td><td>A.C</td><td>F.R</td><td colspan="4">DATA TRANS</td> </tr> <tr> <td>.</td><td>2</td><td>5</td><td colspan="4">ENT</td> </tr> </table>	FUN	DATE	APPL.No	μm/mils	LIMIT	B.INC	APPL.No		7	0	3	.	1	0	LIMIT	A.C	F.R	DATA TRANS				.	2	5	ENT				# DATE 03.10.25	① — *** DATE 03.10.25 ***
FUN	DATE	APPL.No	μm/mils	LIMIT	B.INC	APPL.No																								
	7	0	3	.	1	0																								
LIMIT	A.C	F.R	DATA TRANS																											
.	2	5	ENT																											
② <table border="1" style="display: inline-table; vertical-align: middle;"> <tr> <td>FUN</td><td>LIMIT</td><td>B.INC</td><td>APPL.No</td><td>APPL.No</td> </tr> <tr> <td></td><td>.</td><td>C</td><td>1</td><td>0</td> </tr> <tr> <td colspan="2">DATA TRANS</td><td>F.R</td><td>APPL.No</td><td>DATA TRANS</td> </tr> <tr> <td colspan="2">ENT</td><td>C</td><td>5</td><td>0</td> </tr> <tr> <td colspan="2"></td><td colspan="3">ENT</td> </tr> </table>	FUN	LIMIT	B.INC	APPL.No	APPL.No		.	C	1	0	DATA TRANS		F.R	APPL.No	DATA TRANS	ENT		C	5	0			ENT			# ↑ =100? - # ↓ =50? -	② — ** U.LIMIT=100 um** ** L.LIMIT=50 um**			
FUN	LIMIT	B.INC	APPL.No	APPL.No																										
	.	C	1	0																										
DATA TRANS		F.R	APPL.No	DATA TRANS																										
ENT		C	5	0																										
		ENT																												
③ <table border="1" style="display: inline-table; vertical-align: middle;"> <tr> <td>FUN</td><td>APPL.No</td><td>B.INC</td><td>DATA TRANS</td> </tr> <tr> <td></td><td>0</td><td>1</td><td>ENT</td> </tr> </table>	FUN	APPL.No	B.INC	DATA TRANS		0	1	ENT	# APPL.No=1?	③ — *** APPL. No=1 ***																				
FUN	APPL.No	B.INC	DATA TRANS																											
	0	1	ENT																											
④ <table border="1" style="display: inline-table; vertical-align: middle;"> <tr> <td>FUN</td><td>LOT</td><td>DEL</td><td>CONT</td><td>μm/mils</td><td>A.C</td><td>B.INC</td> </tr> <tr> <td></td><td>8</td><td>9</td><td>6</td><td>3</td><td>2</td><td>1</td> </tr> <tr> <td colspan="7">DATA TRANS</td> </tr> <tr> <td colspan="7">ENT</td> </tr> </table>	FUN	LOT	DEL	CONT	μm/mils	A.C	B.INC		8	9	6	3	2	1	DATA TRANS							ENT							# LOT 96321?	④ — *** LOT 96321 ***
FUN	LOT	DEL	CONT	μm/mils	A.C	B.INC																								
	8	9	6	3	2	1																								
DATA TRANS																														
ENT																														
⑤ <p style="text-align: center;">Measurement</p>	#FE(NF) 0001 83.7 - . .	⑤ — N=0001 B=01 83.7um N=0002 B=01 83.4um N=0003 B=01 85.8um N=0004 B=01 56.0um N=0005 B=01 83.1um																												
⑥ <table border="1" style="display: inline-table; vertical-align: middle;"> <tr> <td>FUN</td><td>B.R</td> </tr> <tr> <td></td><td>4</td> </tr> </table>	FUN	B.R		4	# BR N=0001-0005	⑥ — BLOCK RESULT																								
FUN	B.R																													
	4																													
⑦ <table border="1" style="display: inline-table; vertical-align: middle;"> <tr> <td>DATA TRANS</td> <td rowspan="2">➔ The block number is increment automatically</td> </tr> <tr> <td>ENT</td> </tr> <tr> <td>DATA TRANS</td> <td></td> </tr> <tr> <td>ENT</td> <td></td> </tr> </table>	DATA TRANS	➔ The block number is increment automatically	ENT	DATA TRANS		ENT		# B.INC B=02 ?	N = 0001-0005 B = 01 AV = 78.4um S = 11.2um MAX= 85.8um MIN= 56.0um																					
DATA TRANS	➔ The block number is increment automatically																													
ENT																														
DATA TRANS																														
ENT																														
⑦ <table border="1" style="display: inline-table; vertical-align: middle;"> <tr> <td>DATA TRANS</td> </tr> <tr> <td>ENT</td> </tr> </table>	DATA TRANS	ENT	#FE(NF)																											
DATA TRANS																														
ENT																														



Operation	Display	PrintOut
<p>⑧ <u>Measurement</u></p>	<pre>#FE 0006 132 -</pre>	<p>⑦</p> <pre> N=0006 B=02 132.0um N=0007 B=02 83.4um N=0008 B=02 84.2um N=0009 B=02 58.7um N=0010 B=02 86.0um </pre>
<p>⑨ ⇒Previous data is erased.</p> <p>FUN DEL 9 CONT 6 DATA TRANS ENT</p>	<pre># DELETE N=6?</pre>	<p>⑧</p>
<p>FUN B.R 4</p>	<pre># BR N=0006-0010</pre>	<p>⑨</p> <pre>N=6 DELETE</pre>
<p>⑩ DATA TRANS ENT</p>	<pre># B.INC B=03?</pre>	<p>⑩</p> <pre> BLOCK RESULT N = 0006-0010 B = 02 AV = 78.1um S = 11.2um MAX= 86.0um MIN= 58.7um </pre>
<p>⑪ C ⇒Block number is set as desired.</p>	<pre># B.INC B=?</pre>	<p>⑪</p>
<p>⑫ DEL 9 DATA TRANS ENT</p>	<pre># B.INC B=9?</pre>	<p>⑫</p> <pre> N=0011 B=09 58.3um N=0012 B=09 58.4um N=0013 B=09 7.4um </pre>
<p>⑬ <u>Measurement</u></p>	<pre>#FE 0011 58.3 -</pre>	<p>⑬</p> <pre>N=0013 DELETE</pre>
<p>⑭ ⇒Erase data immediately after measurement</p> <p>FUN DEL 9 DATA TRANS ENT</p>	<pre>#FE 0013 7.4 -</pre>	<p>⑭</p> <pre> N=0013 B=09 58.4um N=0014 B=09 85.5um N=0015 B=09 57.9um </pre>
<p>⑮ <u>Measurement</u></p>	<pre>#FE 0013 58.4 -</pre>	<p>⑮</p> <pre> BLOCK RESULT N = 0011-0015 B = 09 AV = 63.7um S = 10.9um MAX= 85.5um MIN= 57.9um </pre>
<p>⑯ FUN B.R 4</p>	<pre># BR N=0011-0015</pre>	<p>⑯</p> <pre> FINAL RESULT N = 0015 AV = 73.1um S = 13.1um MAX= 86.0um MIN= 56.0um </pre>
<p>⑰ C</p>	<pre>#FE</pre>	
<p>⑱ FUN F.R 5</p>	<pre># FR N=0015</pre>	

8. Functions

(1) Entering the Date







- Example: Entering the date as October 25, 2003

Step	Operation	Display
①		# FUNCTION KEY
②	 7	# DATE ?
③	 0  3  .  1  0  .  2  5	# DATE 03.10.25
④	 ENT	*** DATE 03.10.25 *** (Example)

This function is used to print out the date. To print the date, press the  key to turn the printer on (the asterisk mark (*) on the LCD panel is replaced by the sharp mark (#)). If the printer is off, "PRINTER OFF" will appear in the display. If you incorrectly input comment numerals, use the  key to erase them and then input them again.

(2) Entering the Lot Number



- Example: ntering 6513 as the lot numbermeasurement.

Step	Operation	Display
①		# FUNCTION KEY
②	 8	# LOT ?
③	 6  5  1  3	# LOT 6513?
④	 ENT	*** LOT 6513 *** (Example)

This function is used to print out lot numbers (numerical comments). This function is used in the same way as the DATE function mode. When lot numbers are changed during measurement all previous data is erased from memory and the unit begins again from measurement number 0001.

(3) AC (All Clear: delete the contents of measurement value memory)



This operation deletes the measurement data, statistical results and comments from the unit's memory.

Step	Operation	Display
①		# FANCTION KEY
②		* A.C N=00001?
③		* FE

(4) $\mu\text{m}/\text{mils}$ (Unit Conversion)

This function mode is used to switch between μm and mils as the unit of measurement.

• Example:

Step	Operation	Display
①		# FANCTION KEY
②		* "mils" ?
③		* FE

The measurement data unit are changed to mils.

To return to μm units, repeat the procedure to switch back to μm units.









(5) LIMIT (Upper and lower limits)

This function mode is used to set upper and lower limits when checking to make sure that measured coating thicknesses fall within a specified range.

An electronic beep will sound and an exclamation point (!) will be printed when a measurement value falls outside the specified range.

- Example: Set upper limit at 100 μ m and lower limit at 50 μ m

Step	Operation	Display
①		# FUNCTION KEY
②		* ↑ =? -
③		* ↑ =100? -
④		* ↓ =? -
⑤		* ↓ =50? -
⑥		**U.LIMIT=100 μ m ** **L.LIMIT=50 μ m ** (Example)





Use the following procedure to erase upper and lower limit setting values from memory.



(6) DEL (Partial deletion of measurement value data)

You can delete specific measurement values such as erroneous measurement data which you do not wish to be used in statistical calculations.

- Example: Delete data for the forth measurement made.





Step	Operation	Display
①		# FANCTION KEY
②		* DELETE N=?
③		* DELETE N=4?
④		* FE

After statistical processing has been done it is not possible to delete a portion of the measurement data used for processing in order to change the processed results.

(6) B. INC (Block Increment)

The Block Increment function mode is used to move the block number to the next or another desired block number and continue measurements without obtaining the block results.

- Example: Move (increment) the next block number from 1 to 5.

Step	Operation	Display
①		# FANCTION KEY
②		* B.INC B=01?
③	* 	* B.INC B=?
④	* 	* B.INC B=5?
⑤		* FE



To move sequentially to the next block (from 1 to 2), skip pressing the

 and  keys and immediately press the  key.

(7) BR (Block Calculation Results)

This function mode is used to obtain statistical calculation results for each block separately. Please note that there must be measurement data for at least two measurements in a block in order to obtain statistical calculation results for that block.

• Example: (PRINTER ON)



Step	Operation	Display
①		# FUNCTION KEY
②		# BR N=0001-0005
		N=0001 B=01 87.2um N=0002 B=01 86.6um N=0003 B=01 87.4um N=0004 B=01 88.2um N=0005 B=01 87.6um BLOCK RESULT N = 0001-0005 B = 01 AV = 87.4um S = 0.5um MAX = 88.2um MIN = 86.6um (Example)

(Press the  key sequentially if you wish to obtain statistical calculation results without a hard copy printout.)

Press the  key to move on to the next operation.

 # B.INC B=02?

When the key is pressed at this point the Block Number is incremented automatically to B = 02.

To move directly to a desired block number, press the  key once to clear the block number, input the desired number and then press the  key.

(Statistical Calculations)

(Calculation Method)

Number of Measurements N

Block Number B

Average Value Av

Standard Deviation S

Maximum Value Max

Minimum Value Min

$$AV = \frac{1}{N} \sum_{i=1}^N X_i$$



$$S = \sqrt{\frac{1}{N-1} \sum_{i=1}^N (AV - X_i)^2}$$

N: No. of measurements

X_i: Measurement Data

(10) F. R. (Final Result: Overall statistical calculations results)

The Final Result function mode is used to obtain the overall statistical calculations results for the measurement data from measurement number N = 0001 to the final measurement made.

The operation is performed in the same way as the block result function except that the  key is used instead of the  key.

When the final result is obtained the unit will request the lot number for subsequent measurement.



The unit will move to the next measurement after the new lot number is input. The next measurement will begin at N=0001, B=01.

Therefore all previous data is erased from memory when the final result is obtained. Please note, however, the upper and lower limit setting will remain. To change these setting perform the limit setting procedure again.

(9) CONT (Continuance)

Measured values are usually held, but the hold mode can be released to perform calibration and measurement when making measurements on complexly shaped objects for which measurement values tend to be unstable, thus allowing you to obtain stable values.

• Example:

Step	Operation	Display
①		# FUNCTION KEY
②		*



The calibration procedure after releasing the hold mode is the same as in (3)-② above. However, in procedures ⑦, ⑨, ⑬ and ⑰, the key is pressed when the display stabilizes with the probe held against the measurement surface. The value is input when the buzzer sounds. If you wish to print out the measured value, turn the printer on and press the ENT key while the probe is held down against the measurement surface. To return to the hold mode again, repeat the same key operation procedure.

Note: Hold mode set display : * NF (FE)

Hold mode released display : *

9. Master Calibration

The master calibration operation is performed in the following way when the probe is replaced.

1. Turn the power one while holding down both the  and  keys.

* ○ ○ ○ ○
(4-digit number)

2. Press the  key.

* ○ ○ ○ ○ ○
(5-digit number)

If no number is displayed, press the tip of the probe against the zero base so that a number is displayed.

3. Press the  key.

* MASTER INF.

4. Point the probe up in the air and press the  key.

* ZERO

5. Press the  key while holding the probe down against the zero base.

* FE APPL. No=1

The buzzer will sound and the display will change.

The "0.0" value displayed will change by ± 0.2 .

Keep the probe held down against the zero base until the display appears as shown to the right.

* FE0001 0.0

6. This completes the master calibration operation.

The unit is now in the Measurement Mode and can be used to make measurements.

10. Notes for Measuring and Handling

(1) Confirm the type of material being measured.

Be sure to check the type of material and select the correct probe type before beginning measurements.



(2) Do not damage the probe or get it dirty.

Accurate measurement results cannot be obtained if the chip on the tip of the probe is damaged or dirty. Do not pound the probe against the measurement surface or move the probe laterally while it is pressed down upon the surface. When finished making measurements, use a soft cloth wet with benzine or alcohol to clean the tip of the probe.



(3) Handle the calibration foils with care.

The thickness of the calibration foils has been measured very precisely. You will not be able to obtain accurate measurement results if you use calibration foils which have been scratched, bent or otherwise damaged. Be particularly careful not to subject the thinnest foil, the $10\mu\text{m}$ foil, to wear.

If a standard foil becomes damaged while being used, please contact the dealer from whom you purchased the tester and order a replacement of the same thickness. Although the thickness of replacement foils may slightly different than that of the original foils, this does not pose a problem for calibration adjustments.



(4) Replace the batteries immediately if the low-voltage indicator is displayed.

The following indicators will be displayed on the LCD panel when the main unit or printer section batteries become weak. Please replace the batteries immediately when these indicators appear.

① % is blinking

Both the main unit and printer section batteries are weak.

② * is blinking

The main unit's batteries are weak.

③ # is blinking

This mark will blink in the display when the printer is used and indicates that either the main unit or printer batteries are weak. If the asterisk (" * ") mark does not blink when the PRINTER ON/OFF button is pressed to turn the printer off, this indicates that the printer section batteries are weak.

(5) Adjustment & Inspection

In order to maintain precise performance the coating thickness testers should be inspected at least once per year. Please contact the merchant from whom you purchased your unit regarding inspection.

- Measurement of paper or a film
After calibration on Iron or Aluminum Substrate, the thickness of paper or a film can be measured on the Iron or Aluminum Substrate.
- The unit will go into the Sleep Mode and "SLEEP" will appear in the display in order to conserve battery power if the unit is not used for measurement for more than approximately 15 minutes with the power on. Measurements cannot be made while the unit is in the Sleep Mode. To resume measurements, press the RESET key to exit the Sleep Mode. Making 10 ~ 20 practice measurements after exiting the Sleep Mode or immediately after turning the power on will result in higher measurement precision.

The logo for Kett, featuring the word "Kett" in a white, sans-serif font on a dark grey rectangular background.

KETT ELECTRIC LABORATORY

1-8-1 Minami-Magome Ota-Ku, Tokyo 143-8507 Japan
Tel. +81-3-3776-1121 Fax. +81-3-3772-3001
URL <http://www.kett.co.jp/> E-mail overseas@kett.co.jp

Caution

- It is strictly prohibited to transfer part or all of this manual without permission.
- The contents of this manual are subject to change without notice.
- The appearances, screens, etc. of the product and accessories displayed on this manual may differ from the actual ones, however, operations and functions are not affected.
- All efforts have been made to ensure the contents of this manual are accurate. However, if you notice any part to be unclear, incorrect, omitted, or the like in this manual, please contact us.
- Be aware that we are not liable for the effects resulting from operations according to this manual regardless of the items above.