

GENERAL DESCRIPTION

The JC5281 series are low dropout linear regulators and optimized to provide a high performance solution for battery power system to delivery low quiescent current. The device offer a new level of cost effective performance in cellular phones, laptop and notebook computers, and other portable devices.

JC5281 can provide output value in the range of 1.0V~3.6V by every 0.1V step.

The JC5281 series are designed to make use of low cost ceramic capacitors which ensure the stability of the output current, and enhance the efficiency in order to prolong the battery life of those portable devices.

The JC5281 regulators are available in SOT-23 packages. Standard products are Pb-free and Halogen-free.

FEATURES

- Input voltage: 2.5V~10V
- Output range: 1.0V~3.6V
(customized by every 0.1V step)
- Output current: 350mA @ $V_{IN}-V_{OUT}=0.7V$
- Dropout voltage: 190mV @ $I_{OUT}=100mA$
- Quiescent current : 1 μ A Typ.
- PSRR: 60dB @ 100Hz
- Recommend capacitor: 1 μ F

APPLICATIONS

- Reference voltage source
- Toys
- Bluetooth, wireless handsets
- Low Consumption Device
- Others portable electronics device

TYPICAL APPLIC

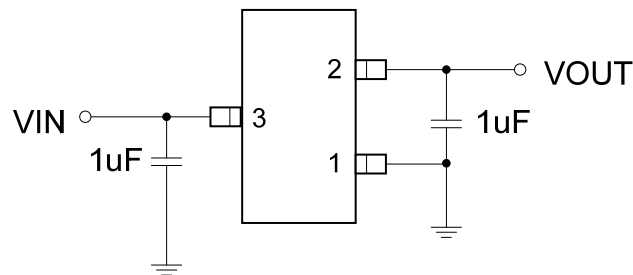

PIN ASSIGNMENT



SOT-23

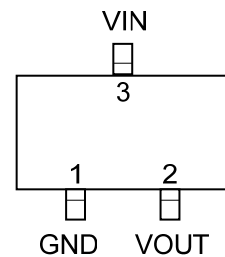

SOT23 (Top View)

ORDER INFORMATION

PART NO	PACAKGE	TEMPERATURE	TAPE & REEL
JC5281AXX	SOT-23	-40 ~+85°C	3000/REEL

Note:XX indicates 1.0V~3.6V by 0.1V step. For example, 33 means product outputs 3.3V

PART NUMBER RULES

JC5281 [1]-[2]

Code	Description
[1]	Package: A: SOT-23
[2]	Voltage version: XX: 1.0V~3.6V by0.1V step Example: 33: 3.3V

MARKING DESCRIPTION:

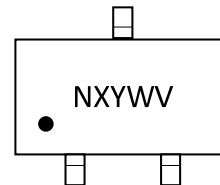

“N”: Product code, here use “S” stands for “JC5281”.

“X”: Packagefactory.

“Y”:Wafer foundry vendor.

“W”: The week of manufacturing. “A” stands for week 1, “Z” stands for week 26, “a” stands for week 27, “z” stands for week 52.

“V”: Product version code.

PIN DESCRIPTION

PIN NO	SYMBOL	I/O	DESCRIPTION
SOT-23			
1	GND	GND	Ground
2	VOU	O	Output
3	VIN	Power	Input

ABSOLUTE MAXIMUM RATINGS(Note)

SYMBOL	ITEMS	VALUE	UNIT
V_{IN}	Input Voltage	-0.3~12	V
I_{OUT}	Output Current	370	mA
P_{DMAX}	Power Dissipation	SOT-23 0.30	W
$R_{\theta JA}$	Thermal Resistance	SOT-23 220	°C/W
T_J	Junction Temperature	-40~125	°C
T_A	Ambient Temperature	-40~85	°C
T_{STG}	Storage Temperature	-55~150	°C

T_{SOLDER}	Package Lead Soldering Temperature (10s)	260	°C
--------------	--	-----	----

Note: Exceed these limits to damage to the device. Exposure to absolute maximum rating conditions may affect device reliability.

RECOMMENDED OPERATING RANGE

SYMBOL	ITEMS	VALUE	UNIT
V_{IN}	Supply Voltage	2.5 to 12	V
T_{OPT}	Operating Temperature	-40 to +85	°C

ELECTRICAL CHARACTERISTICS

The following specifications apply for $V_{OUT}=3.3V$, $T_A=25^{\circ}C$, unless otherwise noted.

SYMBOL	ITEMS	CONDITIONS	MIN	TYP	MAX	UNIT
V_{IN}	Input Voltage				12	V
V_{OUT}	Output Voltage	$V_{OUT}>1.2V, V_{IN}=V_{OUT}+1V, I_{OUT}=1mA$	$V_{OUT}\times 0.98$	V_{OUT}	$V_{OUT}\times 1.02$	V
		$V_{OUT}\leq 1.2V, V_{IN}=2.5V, I_{OUT}=1mA$	$V_{OUT}-25mV$	V_{OUT}	$V_{OUT}+25mV$	
I_Q	Quiescent Current	$V_{OUT}=3.3V, I_{OUT}=0$		1	2	μA
I_{LIMIT}	Current Limit	$V_{IN}-V_{OUT}=1V$		420		mA
V_{DROP}	Dropout Voltage	$V_{OUT}=3.3V, I_{OUT}=50mA$		95		mV
		$V_{OUT}=3.3V, I_{OUT}=100mA$		190		
ΔV_{LINE}	Line Regulation	$V_{IN}=4.3\sim 5.5V, I_{OUT}=1mA$			6	mV
ΔV_{LOAD}	Load Regulation	$V_{IN}=V_{OUT}+1V, I_{OUT}=1\sim 300mA$			36	mV
I_{SHORT}	Short Current	V_{OUT} Short to GND with 1Ω	50	90	190	mA

SIMPLIFIED BLOCK DIAGRAM

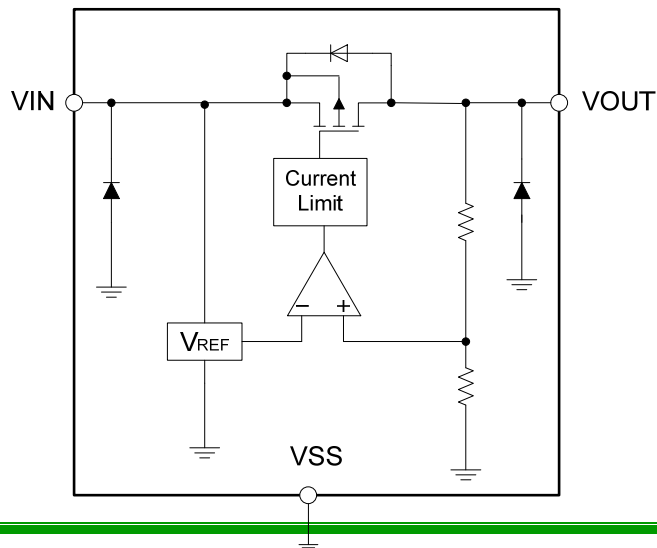

TYPICAL PERFORMANCE CHARACTERISTICS

$C_{IN}=1\mu F, C_{OUT}=1\mu F, T_{OPT}=25^{\circ}C, V_{IN}=5V, V_{OUT}=3.3V$, unless otherwise noted.

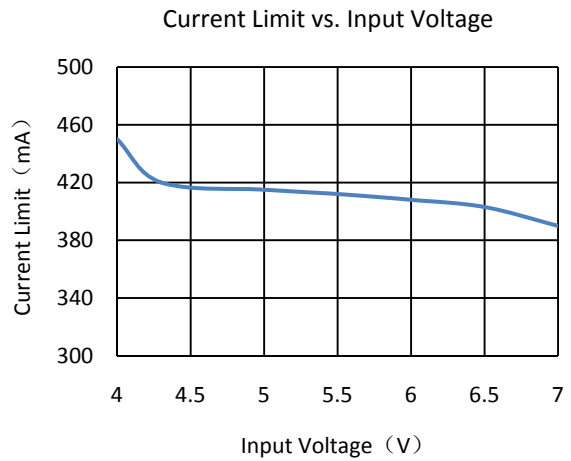
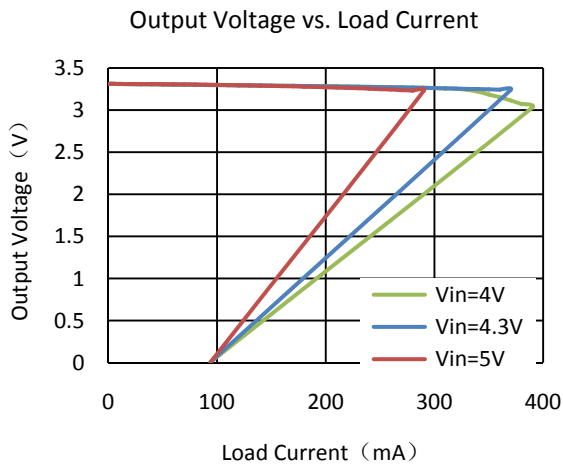
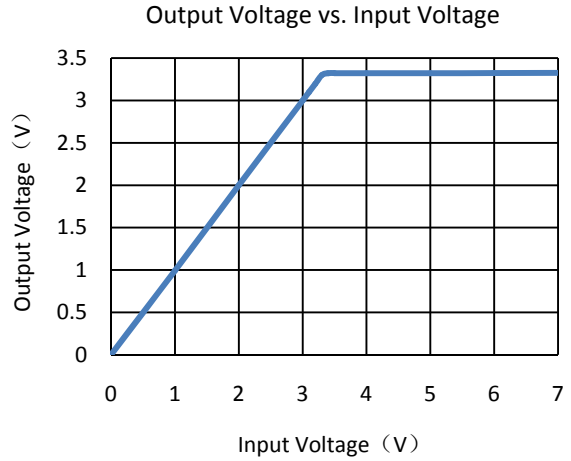
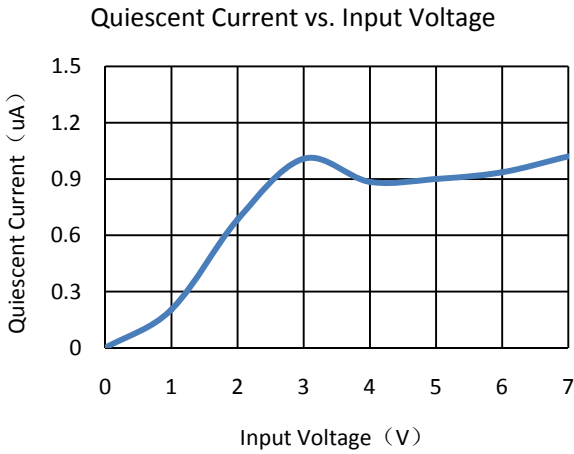

Output Voltage vs. Temperature

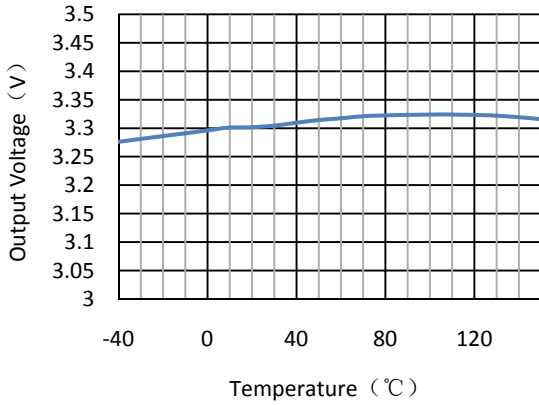

Short Current vs. Input Voltage

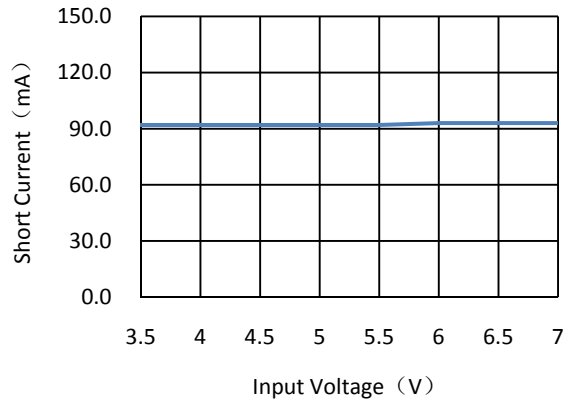

Power ON

CH1: V_{IN} CH2: V_{OUT}

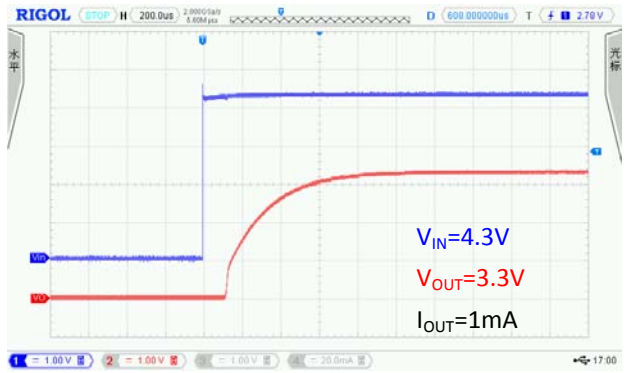
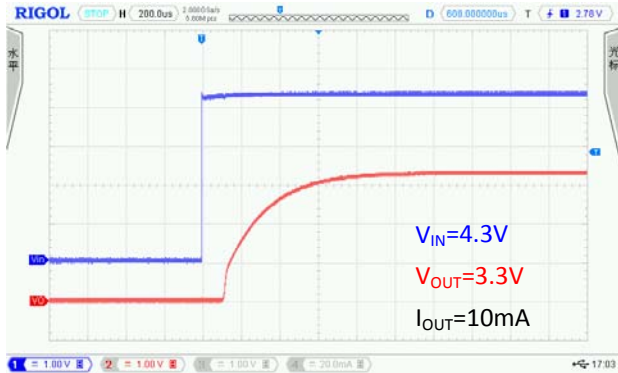

Line Transient Response

CH1: V_{IN} CH2: V_{OUT}



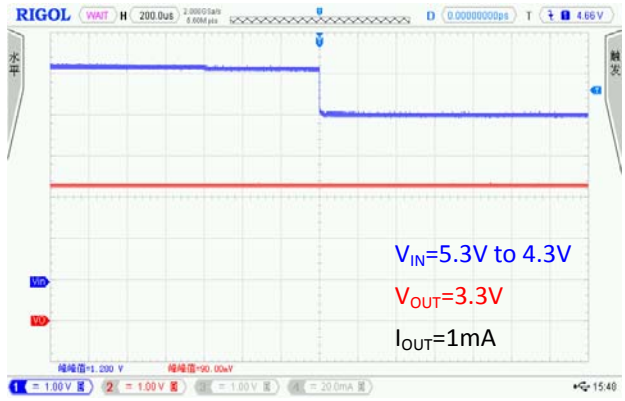
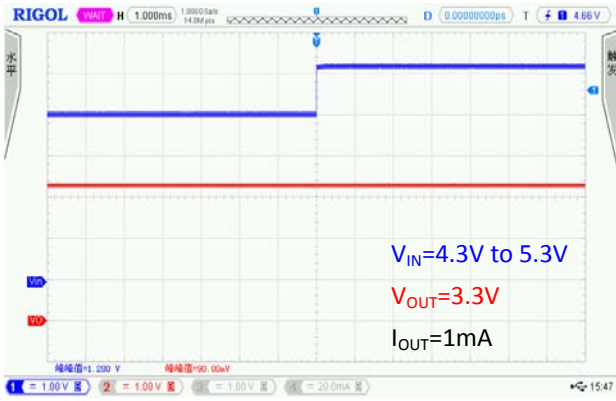

Load Transient Response

CH1: V_{IN} CH2: V_{OUT} CH4: I_{OUT}

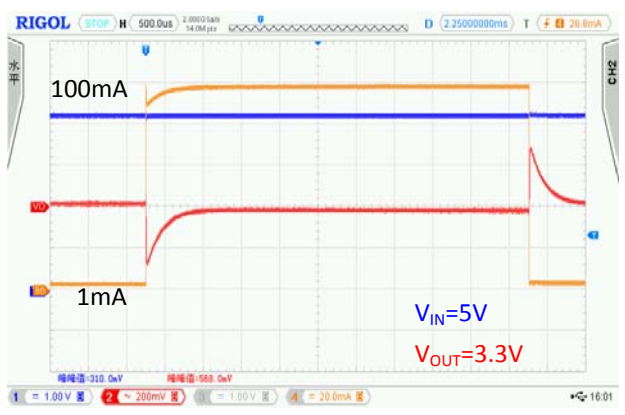
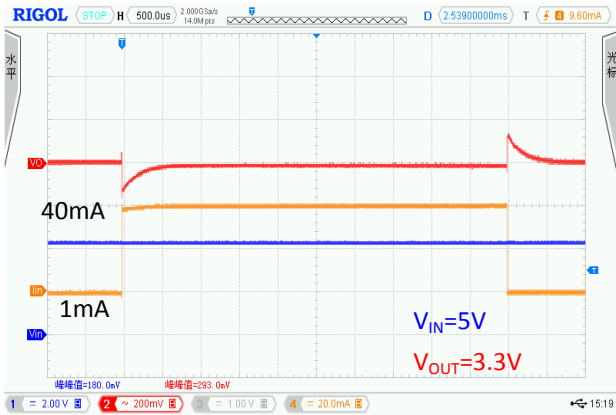

PACKAGE OUTLINE

Package	SOT-23	Devices per reel	3000Pcs	Unit	mm
---------	--------	------------------	---------	------	----

Package Dimension:

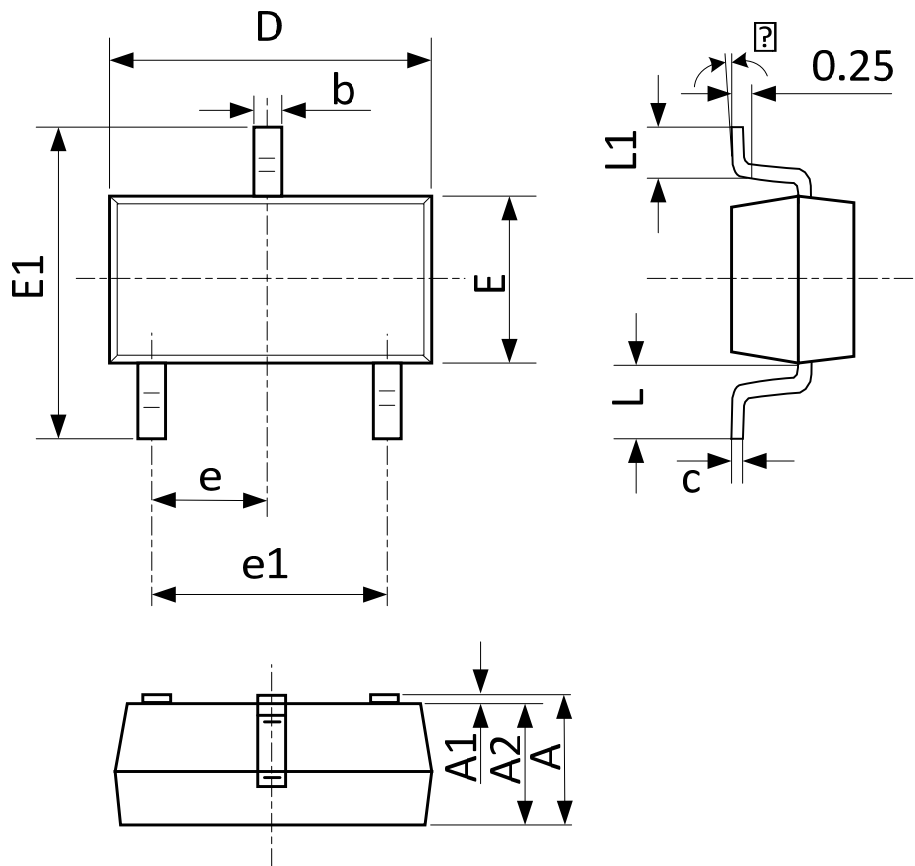

Symbol	Dimensions In Millimeters		Dimensions In Inches	
	Min	Max	Min	Max
A	0.900	1.150	0.035	0.045
A1	0.000	0.100	0.000	0.004
A2	0.900	1.050	0.035	0.041
b	0.300	0.500	0.012	0.020
c	0.080	0.150	0.003	0.006
D	2.800	3.000	0.110	0.118
E	1.200	1.400	0.047	0.055
E1	2.250	2.550	0.089	0.100
e	0.950(BSC)		0.037(BSC)	
e1	1.800	2.000	0.071	0.079
L	0.550(BSC)		0.022(BSC)	
L1	0.300	0.500	0.012	0.020
θ	0°C	8°C	0°C	8°C

REVISION HISTORY

Version No.	Date	Description
Preliminary	2017-09-30	- Initial preliminary release
Version 1.0	2017-10-23	- Update Features. - Update Electrical Characteristics. - Update Typical Performance Characteristics.
Version 1.1	2017-10-31	- Update output voltage range from 1.2~3.6V to 1.0~3.6V. - Update input voltage range from 6.5V to 7V.
Version 1.2	2018-01-23	- Update Typical Performance Characteristics.