

中国工信部高精度传感器一条龙应用计划示范项目

国家级专精特新“小巨人”企业，国家级高新技术企业

中国工业强基重点产品，中国工信部传感器一条龙应用计划示范企业

## 超声波位移传感器

## Ultrasonic Displacement Sensor



## 超声波位移传感器

## Ultrasonic Displacement Sensor

- Demonstration project of one-stop application plan for high-precision sensors of Ministry of Industry and Information Technology of China
- National level specialized and special new "little giant" enterprise, national level high-tech enterprise
- Key products of strong industrial base in China, demonstration enterprise of sensor one-stop application plan of Ministry of Industry and Information Technology of China

# MCSB系列超声波位移传感器

## MCSB Series Ultrasonic Displacement Sensor

### 产品概述 Product overview

米朗超声波传感器是一种振动频率高于声波的机械波，由换能晶片在电压的激励下发生振动，利用超声波的特性研制而成的传感器。它具有频率高、波长短、绕射现象小，特别是方向性好、能够成为射线而定向传播等特点。

超声波测距一般采用飞行时间法TOF(Time of Flight)。传感器到障碍物的距离 $S=vt/2$ 。根据超声波发射和接收之间的飞行时间原理进行测量，利用声波介质对被检测物进行非接触式无磨损的检测，对透明或有色物体，金属或非金属物体，固体、液体、粉状物质均能检测。其检测性能不受工件颜色、材质、透明度的影响，包括烟尘环境和雨天。可广泛应用在物位（液位）监测，机器人防撞，各种超声波接近开关，以及防盗报警等相关领域，工作可靠，安装方便，防水型，发射夹角较小，灵敏度高，方便与工业显示仪表连接。

Miran ultrasonic sensor is a kind of mechanical wave whose vibration frequency is higher than that of sound wave. It is developed by using the characteristics of ultrasonic wave and vibrates under the excitation of voltage. It has the characteristics of high frequency, short wavelength, small diffraction phenomenon, especially good directivity, and can become a ray and directional propagation.

Ultrasonic ranging generally adopts the Time of Flight (TOF) method. Distance from sensor to obstacle  $S=vt/2$ . According to the principle of time of flight between ultrasonic transmission and reception, the acoustic medium is used for non-contact non-wear detection of the detected object, transparent or colored objects, metal or non-metal objects, solid, liquid, powder substances can be detected. Its detection performance is not affected by the color, material, transparency of the workpiece, including dust environment and rainy days. It can be widely used in level (liquid level) monitoring, robot collision prevention, various ultrasonic proximity switches, as well as anti-theft alarm and other related fields, reliable work, easy installation, waterproof type, small launch angle, high sensitivity, convenient connection with industrial display instruments.

### 接线定义 Wiring Definition

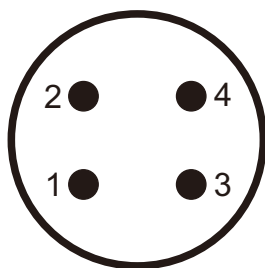

从针的方向看  
From the direction of the needle

■ 1蓝线: 电源负极 GND 0V

1 Blue line: negative terminal of the power supply GND 0V

■ 2灰线: 学习线

2 Grey line: learning line

■ 3黑线: 信号输出

3 Black line: Signal output

■ 4棕线: 电源正极 +DC 15~30V

4 Brown line: positive terminal of the power supply +DC 15~30V



## 性能参数 Performance Parameters

## ⚡ 电气指标 Electrical indicators

| 型号<br>Model                       | MCSB-A1/B/C/D/E系列 series      |                             |                             |
|-----------------------------------|-------------------------------|-----------------------------|-----------------------------|
| 测量范围<br>Measurement range         | 70~1070mm                     | 防护等级<br>Protection grade    | IP67                        |
| 盲区<br>Blind area                  | 70mm                          | 壳体材料<br>Shell material      | 黄铜镀镍<br>Nickel plated brass |
| 工作电流<br>Working current           | ≤40mA                         | 线长<br>Line length           | 2米<br>2 meters              |
| 分辨率<br>Resolution ratio           | 0.35mm(max)                   | 波束角<br>Beam angle           | 10~15°                      |
| 标准检测板<br>Standard detection board | 300x300mm                     | 精度<br>Accuracy              | 0.1%                        |
| 工作电压<br>Working voltage           | 15~30VDC                      | 换能器频道<br>Transducer channel | 200KHz                      |
| 工作温度<br>Operation temperature     | -20°C~+60°C                   | 纹波电压<br>Ripple              | 5%                          |
| 储藏温度<br>Storage temperature       | -40°C~+80°C                   |                             |                             |
| 输出方式<br>Output                    | 0-5V/0-10V/4-20mA/RS485       |                             |                             |
| 响应时间<br>Response time             | 约100ms<br>Approximately 100ms |                             |                             |

| 型号<br>Model                       | MCSB-A2系列 series  |                             |                |
|-----------------------------------|---|-----------------------------|----------------|
| 测量范围<br>Measurement range         | 250~4250mm  | 防护等级<br>Protection grade    | IP67           |
| 盲区<br>Blind area                  | 250mm   | 储藏温度<br>Storage temperature | -40°C~+80°C    |
| 响应时间<br>Response time             | 约160ms<br>Approximately 160ms   | 线长<br>Line length           | 2米<br>2 meters |
| 标准检测板<br>Standard detection board | 300x300mm   | 波束角<br>Beam angle           | 25°            |
| 重复精度<br>Repeat accuracy           | 0.3%  | 线性精度<br>Linear accuracy     | ± <1%          |
| 工作电压<br>Working voltage           | DC24V   | 换能器频道<br>Transducer channel | 75KHz          |
| 工作温度<br>Operation temperature     | -20°C~+60°C   | 纹波电压<br>Ripple              | 5%             |
| 分辨率<br>Resolution ratio           | 量程的0.1%(0.5mm min)<br>0.1% of range (0.5mm min)   |                             |                |
| 输出方式<br>Output                    | 0-5V/0-10V/4-20mA/RS485   |                             |                |
| 壳体材料<br>Shell material            | 默认: 黄铜镀镍; 可定制: 不锈钢外壳<br>Default: Nickel plated brass; Customizable: Stainless steel housing |                             |                |

产品命名规则 Product Naming Rules

MCSB

米朗超声波传感器  
Miran ultrasonic sensor

检测量程 (mm)  
Detection range (mm)

V1:0-5V输出  
V1:0-5V output  
V2:0-10输出  
V2:0-10 output  
A:4-20mA输出  
A:4-20mA output  
R: RS485输出  
R: RS485 output

A1: 长螺纹电子仓 (量程1000mm)  
A1: Long threaded electronic compartment (range 1000mm)  
A2: 长螺纹电子仓 (量程4000mm)  
A2: Long threaded electronic compartment (range 4000mm)  
B: 短螺牙型短电子仓  
B: Short screw type short electronic bin  
C: 支架型短电子仓  
C: bracket type short electronic warehouse

C: 防水接头出线  
C: The waterproof connector is routed  
P: 航空插头出线  
P: Aviation plug out

注: RS485信号输出目前限A1,A2型可做, B/C/D/E型的RS485信号输出正在开发中, 如有需要请与技术人员联系。

Note: RS485 signal output is currently limited to A1 and A2 models, while RS485 signal output for B/C/D/E models is under development. Please contact technical personnel if needed.



A1: 长螺纹电子仓 (量程1000mm, 直径18mm)  
A1: Long threaded electronic bin  
(Measuring range 1000mm, Diameter 18mm)



A2: 长螺纹电子仓 (量程4000mm, 直径30mm)  
A2: Long threaded electronic bin  
(Measuring range 4000mm, Diameter 30mm)



B: 短螺牙型短电子仓 (量程1000mm)  
B: Short screw type short electronic chamber  
(Measuring range 1000mm)



C: 支架型短电子仓 (量程1000mm)  
C: Bracket type short electronic bin  
(Measuring range 1000mm)



D: U型支架型短电子仓 (量程1000mm)  
D: U-bracket type short electronic warehouse  
(Measuring range 1000mm)

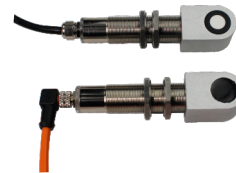

E: 垂直安装型电子仓 (量程1000mm)  
E: Vertically mounted electronic bin  
(Measuring range 1000mm)

产品尺寸图 Product Dimension Diagram

A1型尺寸: L78mm\*W18mm\*H18mm(最大量程: 1000mm)

A1-type size: L78mm \* W18mm \* H18mm(Maximum range: 1000mm)

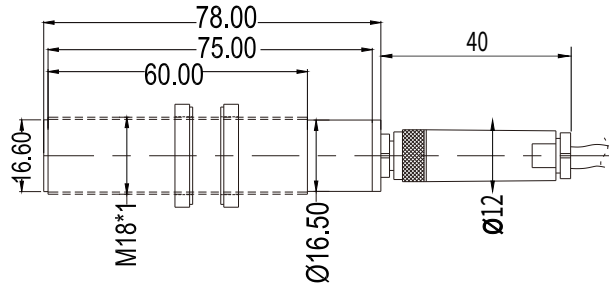
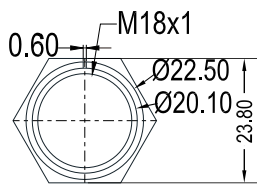
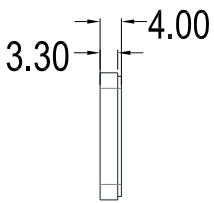

A2型尺寸: L104mm\*W30mm\*H30mm(最大量程: 4000mm)

A2-type size: L104mm \* W30mm \* H30mm (maximum range: 4000mm)

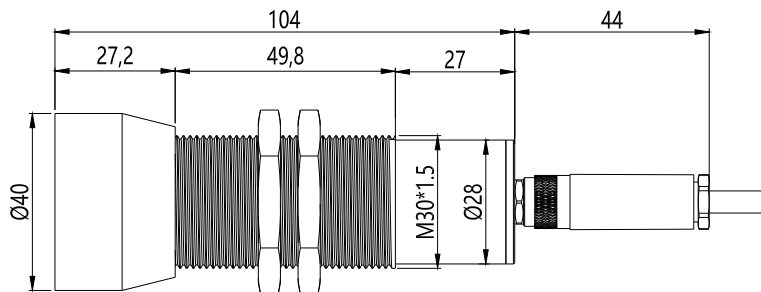
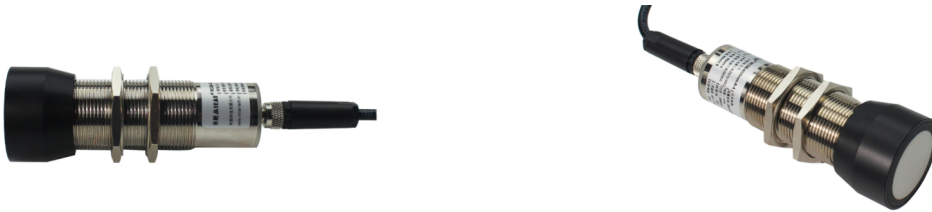

产品尺寸图 Product Dimension Diagram

B型尺寸: L42mm\*W40mm\*H38mm(最大量程:1000mm)

B-type size: L42mm \* W40mm \* H38mm (maximum range: 1000mm)

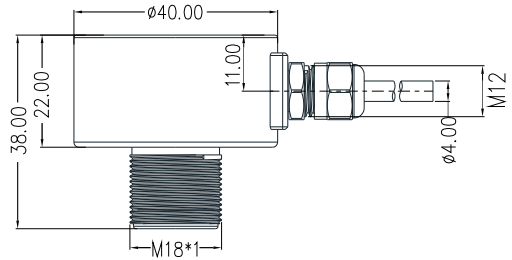
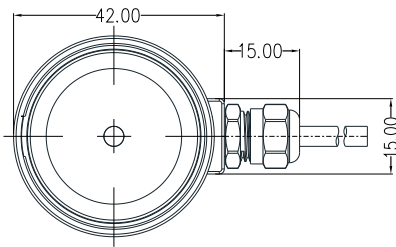
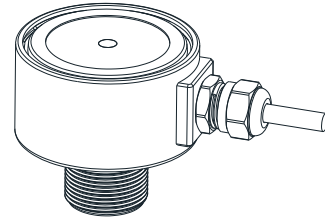

C型尺寸: L42mm\*W60mm\*H37mm(最大量程:1000mm)

C-type size: L42mm \* W60mm \* H37mm (maximum range: 1000mm)

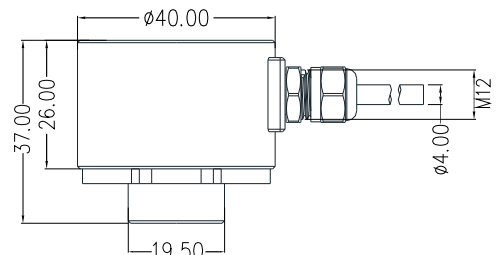
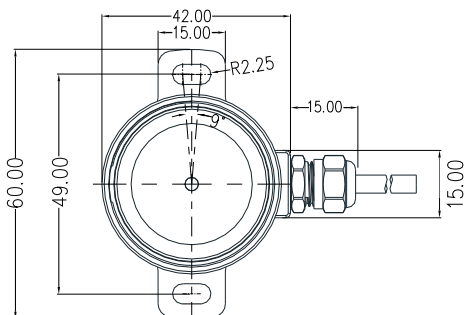
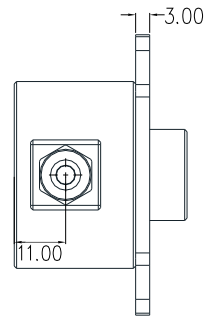
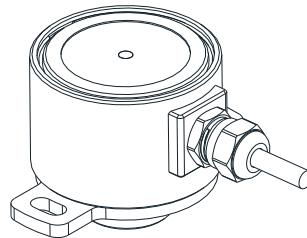

产品尺寸图 Product Dimension Diagram

D型尺寸: L42mm \* W51mm \* H37mm (最大量程: 1000mm)

D-type size: L42mm \* W51mm \* H37mm (maximum range: 1000mm)

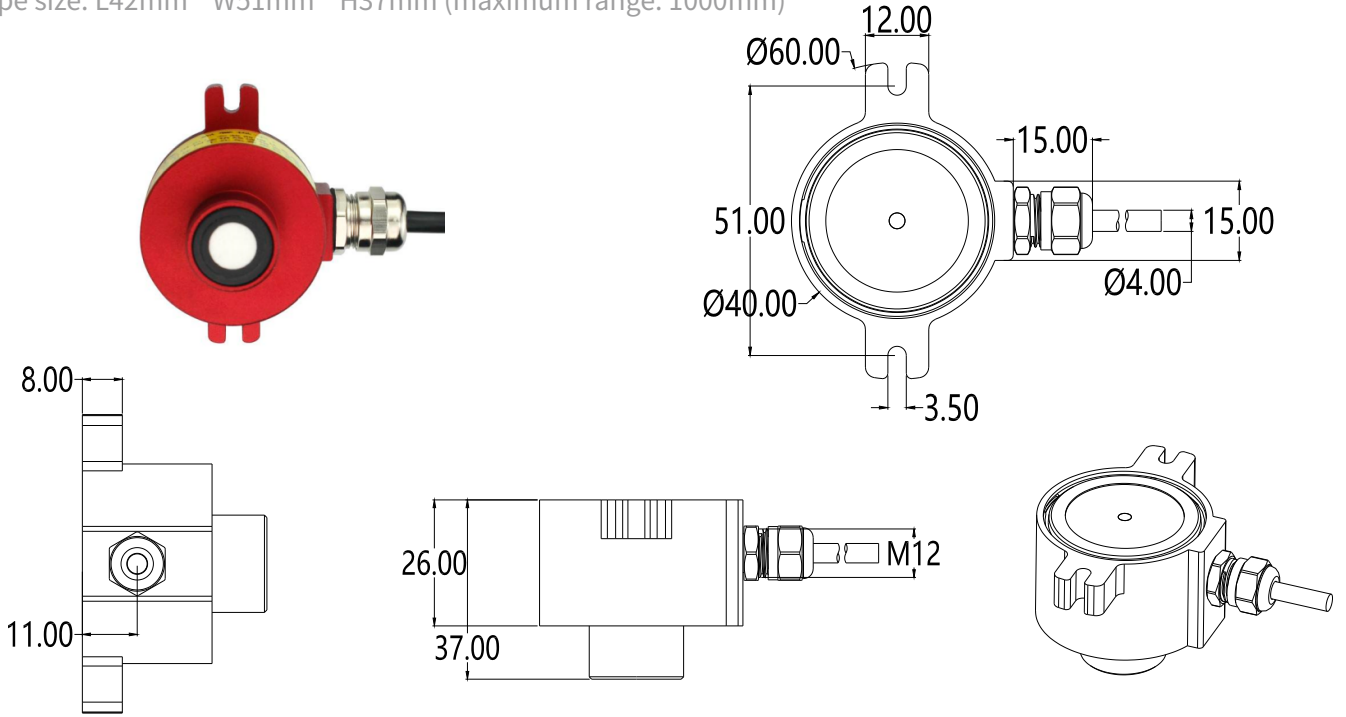

E型尺寸: L100mm \* W24mm (最大量程: 1000mm)

E-type size: L100mm \* W24mm (maximum range: 1000mm)

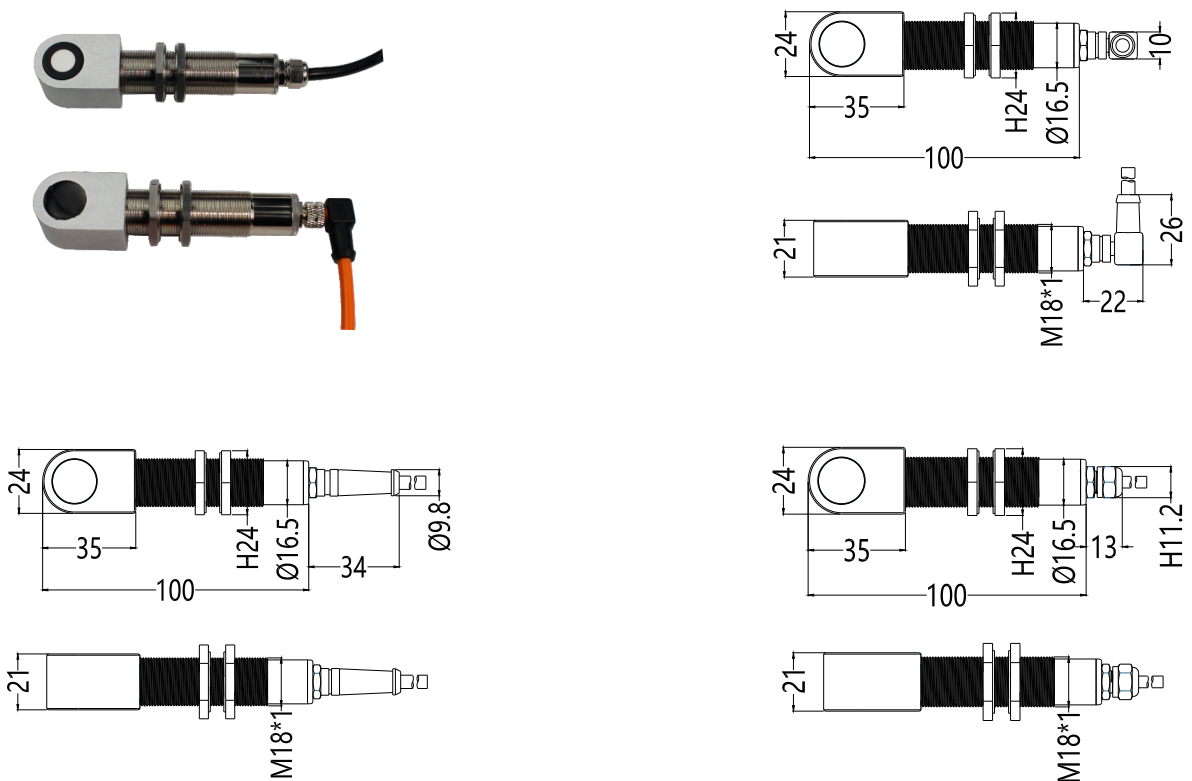

## 调节方法 Adjustment method

超声波传感器设定测量距离时，需要选取传感器距离被测物较近的点(P1)与传感器距离被测物较远的点(P2)两个点，这两个点可以任意设定为零点或终点。

When setting the measurement distance for ultrasonic sensors, it is necessary to select two points: the point where the sensor is closer to the measured object (P1) and the point where the sensor is farther from the measured object (P2). These two points can be arbitrarily set as zero or endpoint.

### 设置零点:

在想要设定距离的地方放一个被测物。将灰线（学习线）和蓝线（电源负）相接，在此期间，如果被测物被捕捉到了，黄色灯会一直闪烁。此状态持续四到五秒之后，把灰线拿开。零点设定成功。

Set zero point:

Place a test object at the desired distance. Connect the gray line (learning line) and the blue line (power negative). During this period, if the measured object is captured, the yellow light will flash continuously. After this state lasts for four to five seconds, remove the gray line. Zero point setting successful.

### 设置终点:

在想要设定距离的地方放一个被测物。将灰线（学习线）和棕线（电源正）接一起，在此期间，如果被测物被捕捉到了，黄色灯会一直闪烁。此状态持续四到五秒之后，把灰线拿开。终点设定成功。

Set endpoint:

Place a test object at the desired distance. Connect the gray line (learning line) and brown line (power positive) together. During this period, if the measured object is captured, the yellow light will flash continuously. After this state lasts for four to five seconds, remove the gray line. The endpoint setting was successful.

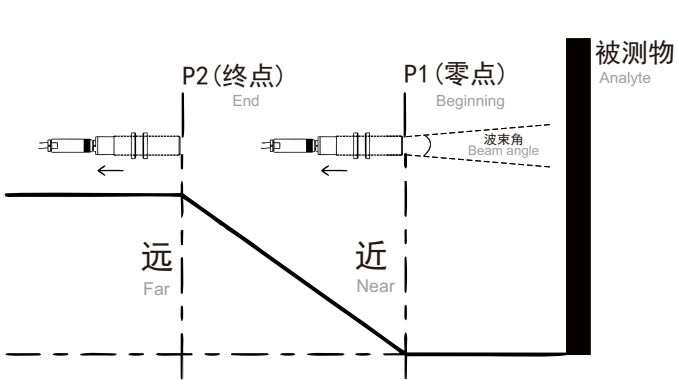

先设置零点，再设置终点，传感器由P1(零点)向P2(终点)移动时,数值是由小到大变化的。

Set the zero point first, then set the endpoint. When the sensor moves from P1 (zero point) to P2 (endpoint), the value changes from small to large.

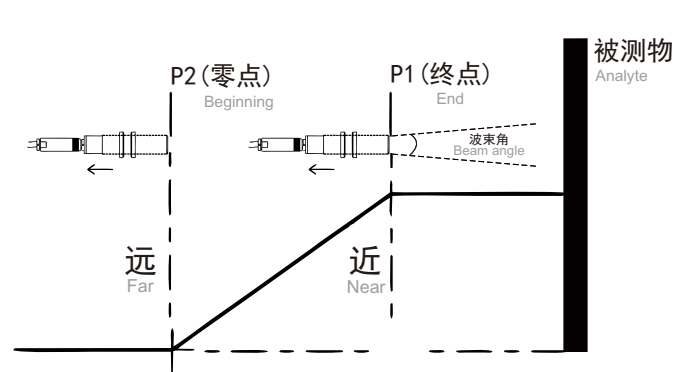

先设置终点，再设置零点，传感器由P1(终点)向P2(零点)移动时,数值是由大到小变化的。

Set the endpoint first, then set the zero point. When the sensor moves from P1 (endpoint) to P2 (zero point), the value changes from large to small.



## 调节方法Adjustment method

首先传感器通电，传感器的后面的红色和黄色指示灯会亮起。

Firstly, the sensor is powered on, and the red and yellow indicator lights behind the sensor will light up.

|  |   |
|--|---|
| <p>指示灯含义<br/>Meaning of indicator lights</p> | <p><b>黄灯：</b>黄灯不变，物体在测量范围内。黄灯闪烁，设定功能状态下检测到物体。<br/>Yellow light:<br/>The yellow light remains unchanged, and the object is within the measurement range. The yellow light is flashing, and an object is detected in the set function state.</p> <p><b>红灯：</b>红灯常亮，电源上电。长暗，出错红灯闪烁，设定功能状态下未检测到物体。<br/>Red light:<br/>The red light is constantly on, and the power is on. Long dark, error red light flashing, no object detected in the set function state.</p> |
|--|---|

**注：**设定过程中可能会出现黄灯和红灯一起闪烁的情况，说明传感器没有准确捕捉到被测物。需要把传感器稍微移动来对准被测物。直至黄灯单独连续闪烁为止。此设定过程必须在3分钟之内完成，否则传感器将被锁定。需要断开电源重新供电，然后重新设定。

Note: During the setting process, there may be yellow and red lights flashing together, indicating that the sensor has not accurately captured the measured object. The sensor needs to be slightly moved to align with the measured object. Until the yellow light flashes continuously and independently. This setting process must be completed within 3 minutes, otherwise the sensor will be locked. It is necessary to disconnect the power and power it back on, and then reset it.

## 注意事项Matters Needing Attention

- 传感器为精密仪器，请勿刮花表面。  
The sensor is a precision instrument, please do not scratch the surface.
- 不能在真空区或防爆区使用该传感器。  
This sensor cannot be used in vacuum or explosion-proof areas.
- 确保传感器的供电电压和纹波电压在规格范围内。  
Ensure that the power supply voltage and ripple voltage of the sensor are within the specified range.
- 请勿在50°C以上的水、蒸汽、酸、溶剂附近使用该传感器。  
Do not use this sensor near water, steam, acid, or solvents above 50 °C.
- 传感器使用时，不能有强烈的机械震动，工作环境不应该有强烈的电磁干扰。  
When using sensors, there should be no strong mechanical vibration and the working environment should not have strong electromagnetic interference.

## 安装说明Installation Instructions

由于超声波传感器具有方向性，因此一定要注意其安装位置。建议安装位置最好和被测物垂直这样测量数据会相对准确。(附带安装固定螺母)

Due to the directionality of ultrasonic sensors, it is important to pay attention to their installation position. It is recommended that the installation position be perpendicular to the object being measured, so that the measurement data will be relatively accurate. (Comes with installation fixing nuts)

荣誉证书Certificate Of Honor

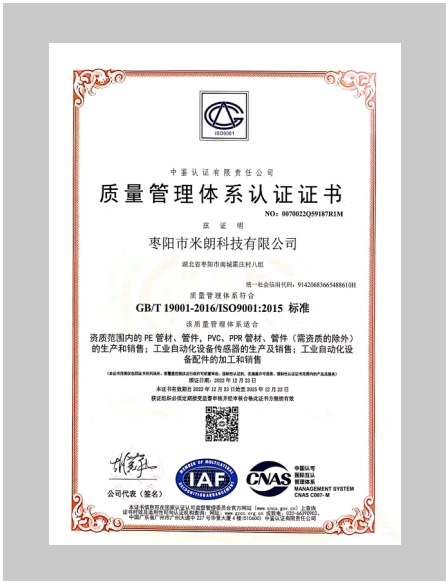
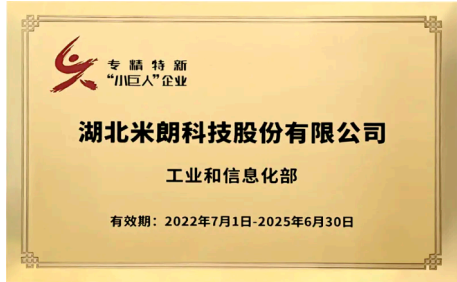
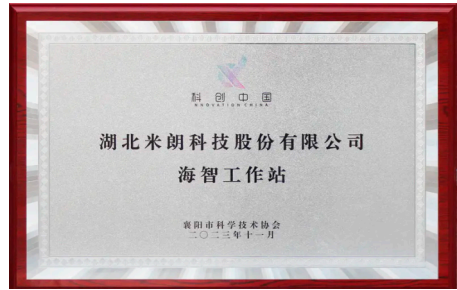
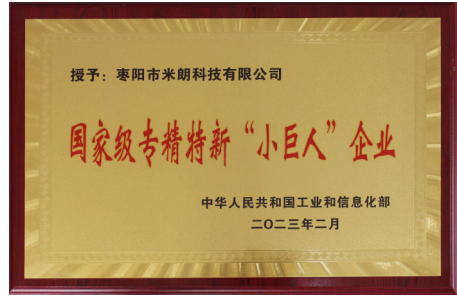
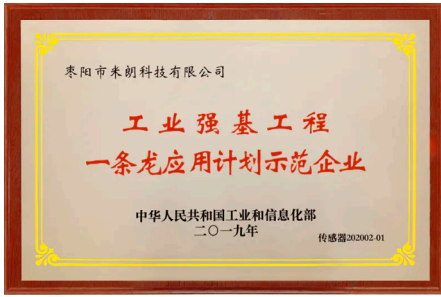

应用领域 Application Area



● 液位测量  
Level measurement



● 材料堆积高度测量  
Measurement of material stacking height



● 间隙测量  
Gap measurement



● 物体计数  
Object Count



● 包装检测  
Packaging inspection

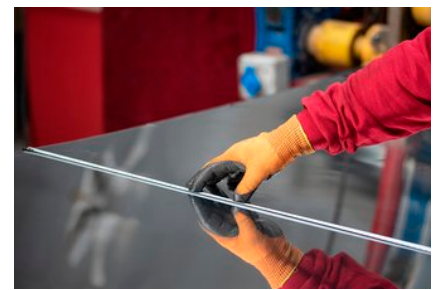

● 尺寸测量  
Tension control



● 直径和速度测量  
Measurement of diameter and velocity



● 高度测量  
Height measurement



超声波位移传感器应用场所极多,随着核心技术的发展,超声波位移传感器得到越来越广泛的应用。适合应用于工厂、山体、铁路、隧道、船业、机械、建筑业、医疗事业、桥梁铺设、水坝建设、汽车行业、核工业和航空航天事业等。

There are many applications for ultrasonic displacement sensors, and with the development of core technology, ultrasonic displacement sensors are becoming increasingly widely used. Suitable for applications in factories, mountains, railways, tunnels, shipbuilding, machinery, construction, medical industry, bridge laying, dam construction, automotive industry, nuclear industry, and aerospace industry.



辐射全国 放眼世界

Radiate nationwide and look around the world

质量第一

Quality First

用户至上

User First

诚信为本

Honesty is the best policy

以技术创新为核心，以客户需求为导向

Centered on technological innovation and guided by customer needs

将致力于位移、物位、角度等测控领域

We will be committed to the measurement and control fields of displacement, level, angle, etc

为客户提供一站式解决方案的产品与服务

Provide customers with one-stop solutions for products and services

版权归深圳市米朗科技有限公司所有  
本选型样本如有变动，恕不另行通知，以最新版本为准  
任何拷贝、复制、拍摄制作作为商业用途均属于侵权  
主要著作人：李工  
2024年04月出品

Copyright belongs to Shenzhen Miran Technology Co., Ltd

This selection sample is subject to change without prior notice, and the latest version shall prevail

Any copy, reproduction, filming and production for commercial purposes is infringing

Main author: Engineer Li

Produced in April 2024